

4X4 SUSPENSION KIT CATALOGUE



Index

INTRODUCTION

General Information

The Company

Why Springs are Replaced

Suspension Range

Ride Height Options

Customer Specific Design

Part Number Interpretation

Glossary

Catalogue Information

Copyright

Bibliography

Application Index

1-6

Vehicle Application Listing



2020 - VERSION

**COIL SPRINGS, LEAF SPRINGS,
URETHANE BUSHINGS,
SHOCK ABSORBERS, STEERING DAMPERS,
TORSION BARS, PANHARD RODS, SHACKLES,
PINS, U-BOLTS & GVM UPGRADE KITS**

Lovells Automotive Systems Pty. Ltd.

A.B.N. 82 139 985 603

Int Ph: **+61 2 9820 6800** Int Fax: **+61 2 9820 6788**

website: www.lovellsauto.com.au

email: sales@lovells.com.au

LOVELLS

SUSPENSION

FOR THE RIDE OF YOUR LIFE

The Company

In the commercially dark and uncertain days of the depression. Lovells Springs founder, George Lovell, took the courageous step of leaving the corporate security of Pioneer Railway Springs Pty Ltd to begin with his three sons, his own company in 1930.

George and his sons manufactured their own spring making equipment including furnaces and forming equipment and as a result of hard work, Australian ingenuity and determination the business flourished. Lovells has cemented their reputation as a world leader, manufacturer and supplier of premium quality springs and suspension components to suit a broad range of applications for automotive, defence, agriculture, mining and railway industries.

The company's philosophy of 'up to a standard, not down to a price' paired with a commitment to customer satisfaction and continuous improvement, provide basis for the quality of product, as well as the quality of business relationships developed with their clients.

Why Springs are Replaced



To achieve improvements in the following areas:

- ◆ Ride Height
- ◆ Handling
- ◆ Load Carrying Capacity
- ◆ Comfort
- ◆ **Ride Height**

To restore a vehicle to its original standard ride height, when the original springs have sagged or weakened. To lower the centre of gravity of the vehicle for enhanced appearance, performance and handling characteristics. To raise the vehicle for increased ground clearance and load carrying capabilities eg. offroad applications, towing, LPG tanks, load bearing accessories.

◆ **Handling**

Lovells Springs ratings exceed that of original equipment springs by around 10%-50% (depending on the application), therefore handling is dramatically improved by controlling excessive body roll and brake dive.

◆ **Load Carrying Capacity**

Lovells offer a vast range of heavy duty uprated coil and leaf springs to increase the vehicles load carrying capabilities and maintain stability when laden. These springs should be selected where a vehicle carries heavy loads, is used for towing, is fitted with LPG or larger fuel tank and other Load Bearing Accessories ie Bull Bar, winch, roof rack etc.

◆ **Comfort**

Lovells offer a range of variances in progressive and linear rate coil spring design, ratings and ride height options to enable the vehicle to be enhanced to the customer's exacting comfort requirements.

Suspension Range

Lovells Coil Springs Designed as a superior replacement part for mass produced O.E. (Original Equipment) coil springs. Lovells springs exceed original ratings by 10%-50%, thus handling is dramatically improved and many ride height variations are available for most makes of vehicles.

Lovells Coil Springs are manufactured to the highest standard from Australian made One Steel micro alloy spring steel.

Many Lovells Coil Springs are of a Progressive Rate design. This design enables a spring to increase in spring rate when you need it and decrease when you don't; ensuring the ultimate in handling and ride comfort. **5 YEAR unlimited km WARRANTY**



Suspension Range (Continued)

Lovells Leaf Springs

Lovells offer a vast range of semi elliptic leaf springs to satisfy popular ride height variations and load carrying capabilities. Lovells semi elliptic springs have the outstanding characteristics of not only acting as a spring, to resiliently support the vehicle, but also serve to position the axle, dampen vertical deflection and cushion both driving torque and braking reaction. Lovells leaf springs are manufactured to the highest standard from Australian made One Steel micro alloy spring steel.

5 YEAR unlimited km WARRANTY



Lovells Urethane Suspension Components

On going development in urethane technology has eventuated in Lovells being able to offer a urethane suspension bush that permits the comfortable ride, associated with rubber bushes, yet with the crisp handling geometry control and durability of urethane. The technology allows #60, #75, durometer urethane to survive the harshest of suspension applications and durability to match.

Lovells Urethane Suspension Components are covered by a 2 YEAR/ 40,000km WARRANTY



Lovells Shock Absorbers (Series III)

GAS LEGEND TWIN-TUBE GAS CHARGED;

40mm bore and huge 60mm expanded body design provides up to twice the oil capacity of Original Equipment shock absorbers to maximise fade resistance, run cooler and allow fast reaction time to road changes.

Gas Legend Twin-Tube shock absorbers feature:

- ◆ Teflon banded steel pistons and nylon mechanical top out stops.
- ◆ Piston retainer nuts, mechanically peened to stop failure at high temperature.
- ◆ Multi stage valving system to allow a progressive dampening effect from slow to fast piston velocity thus automatically adjusting to all conditions.
- ◆ Shafts are manufactured from tough 20mm hardened chrome micro alloy steel, precision engineered to withstand the harshest of environments, while reducing friction and wear.
- ◆ Piston rod seals are Viton high quality, high temperature multi-lip design to again reduce friction and provide longer life.
- ◆ Robust 1.5mm thick external and internal walls.

- ◆ Gas charged with low pressure nitrogen gas to maximise fade resistance under extreme conditions without harshness while providing more responsive control.
- ◆ All eyes and pin mounts are doubled welded for extra strength and long life.

Lovells Gas Legend Shock Absorbers are covered by 3 YEAR/ 70,000km WARRANTY.



Lovells Steering Dampers/Stabilisers

GAS LEGEND HEAVY DUTY and RETURN TO CENTRE; Large capacity replacement steering dampers have a 30mm bore and piston and incorporate Foam Cell technology.

Reduce unwanted steering vibration and harshness on rough roads, without interfering with normal steering control. Absorbs steering shock and vibration caused by road irregularities such as cracks, corrugations, holes, rocks and wheel tracks.

Gas Legend Steering Dampers feature:

- ◆ Superior 12.5mm hard chrome piston rod.
- ◆ Tough cold coiled coil spring on RTC versions.
- ◆ 50/50 Multi stage valving system to allow a progressive dampening effect from slow to fast piston velocity thus automatically adjusting to all conditions.

◆ Mounts are Robotic Double Welded

Lovells Gas Legend Steering Dampers are covered by 3 YEAR/ 70,000km WARRANTY.



Lovells Heavy Duty Torsion Bars

Bars are available as an up grade to enhance the load carrying ability of vehicles which have independent front ends. Lovells Torsion Bars are manufactured with larger diameter bar than original equipment which will increase spring rate and maintain ride height when the vehicle is fitted with load bearing accessories (LBA) over the front. Eg. Bull bar or winch. Lovells Torsion Bars feature 'upset' forged ends which increase strength by improving the steel structure and rolled splines. Lovells heavy duty torsion bars are covered by a 2 YEAR/ 40,000 km WARRANTY



Suspension Range (Continued)

Lovells Shackles & Pins

Manufactured using the finest quality materials and case hardened to 0.2mm, to provide greater resistance to wear, thus increasing pin and bush life. Machined load bearing surfaces allow for increased dispersion and coverage of grease, which greatly improves performance and reduces shackle and pin deterioration.

All Lovells shackles, plates and pins are manufactured to exceed Original Equipment specifications. The majority of Lovells shackles and pins are fully greaseable with easy accessible grease nipples and come complete with nuts & washers.

Lovells shackles and pins are covered by a 2 YEAR/ 40,000km WARRANTY.



Lovells U-Bolts

Manufactured from high tensile premium quality cold formed rod, incorporating rolled threads to ensure material structure continuity and increased strength. Lovells U-bolts are coated with a rust preventative for long life and come complete with high tensile deep nuts and spring washers. Lovells U-bolts are covered by a 2 YEAR/ 40,000km WARRANTY.



Lovells Suspension Kits

Lovells offer complete 4x4 suspension kits, with properly 'matched' components to ensure vehicle handling characteristics and load carrying ability are correct, safe and uncompromised. To achieve this, Lovells initially carry out an evaluation of a vehicle via road testing, component analysis and performance and specification examination. Road testing involves driving a vehicle over many types of terrain, with and without loads before subjective

judgement is made on how Lovells could improve the performance of the vehicle in terms of ride height, handling, load carrying capacity (up to the manufacturers recommended GVM). Suspension systems are then designed as a combination to ensure spring rates, suspension travel and handling compliment our shock absorber controls and other components. Performance including load capabilities verses ride comfort is also taken into consideration. Engineering samples are left on a vehicle for *durability* testing for periods of up to 12 months.



Lovells Gross Vehicle Mass (GVM) Upgrades and Towing Upgrades (BTC Upgrades)

The solution for owner/managers of most popular 4x4 vehicles who need to carry and tow loads beyond OE capacities while at the same time meeting practical and documentary compliance requirements of Work Safety, Police Licensing, Insurance, Lessors and Fleet Managers.

The Lovells GVM and BTC upgrade kits have been strenuously studied, tested and refined. In conjunction with leading Engineering Signatories and have been fitted to many of Australia's largest fleets during the past twenty years. Lovells GVM Upgrade Kits have full Federal Compliance by the Department of Infrastructure, Transport, Regional Development and Local Government and all have specific Compliance plate Approvals and Compliance plates fitted to prior to registration. They are simply then registered with a new GVM as per the new compliance plate.

Lovells GVM Upgrade and BTC Upgrade Kits come complete with all suspension components, All Terrain Offroad Hitch, new compliance plate and full fitting and testing procedures.



Ride Height Options

Vehicle ride heights (Eye Brow Heights) are measured vertically from the centre of the wheel hub to the edge of the guard.

Vehicle ride heights are approximate only and can vary depending on:

- ◆ Age of vehicle
- ◆ Load Bearing Accessories (ie. bullbars, winches, extra fuel tanks, fridges, spare wheel carrier etc.)

When selecting springs all of the these factors must be taken into consideration.

Eye Brow Height

Measuring of the "Eye Brow Height -E.B.H." is illustrated in the following Diagram

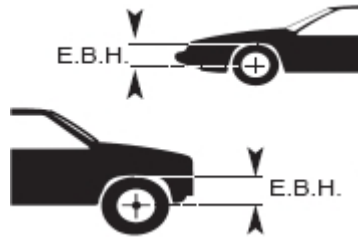

FRONT / REAR

IMPORTANT: Pay close attention to all symbols, foot

Customer Specific Design and Spring Identification

If the springs you require are not listed in the catalogue, please make enquiries with our customer service technicians who will arrange for the manufacture of custom springs to your specification and / or sample.

To achieve initial design parameters we will require the following:

Static (working) height: The length of the coil spring whilst still mounted in the vehicle under normal load.

Trapped height: The overall length of a coil spring

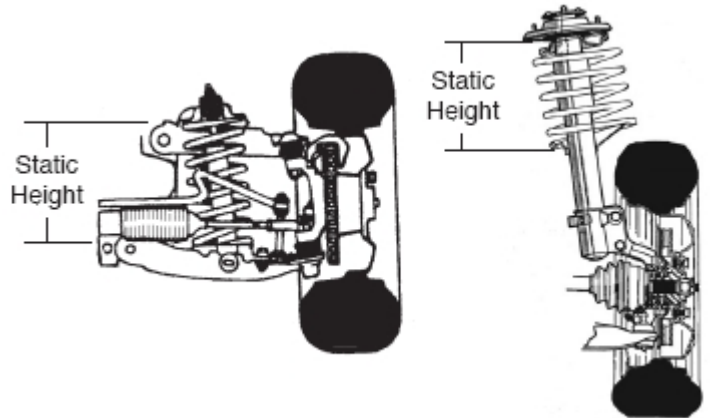

when still in the vehicle while the body of the vehicle is jacked up, to full extension of shock absorber.

Free height: The overall length of a coil spring at its longest part while not under load i.e. out of the vehicle

Designation	Approximate ride height change
Std Height	Standard
H/Duty Std Height Raised	Maintains Std Height when vehicle is fitted with Load Bearing Accessories. Raises vehicle by approx 25-50mm
Raised H/Duty	Maintaining raised height when vehicle is fitted with Load Bearing Accessories - increasing load carrying capacity.
Additional Part No. Prefix	<p>HD - (Heavy Duty) extra heavy duty for increased load carrying capacity ie. larger fuel tanks, LPG tanks, camping / trekking cargo.</p> <p>LTO - (Long Travel Option) suits 4x4 vehicles with aftermarket shock absorbers which are normally longer than original and enable coil spring to remain trapped. LTO part numbers also suit O.E. original length shock absorbers.</p> <p>HDLTO - (Heavy Duty Long Travel Option) above two descriptions combined, suits 4x4 vehicles with longer shock absorber & increases load carrying capacity.</p> <p>NOTE: Spring selection for vehicles with L.B.A must be scrutinised carefully as variables such as location of equipment may change from vehicle to vehicle. The above details are given as an average only. Please consult Lovells Springs Pty. Ltd. for further details.</p>

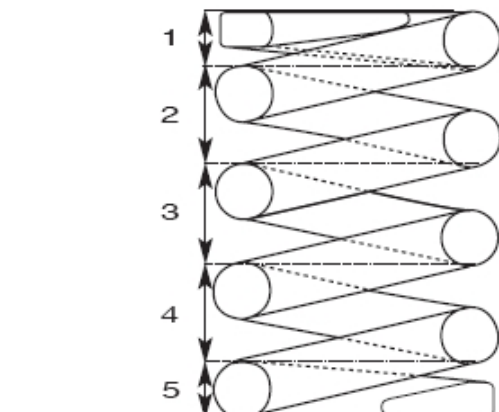
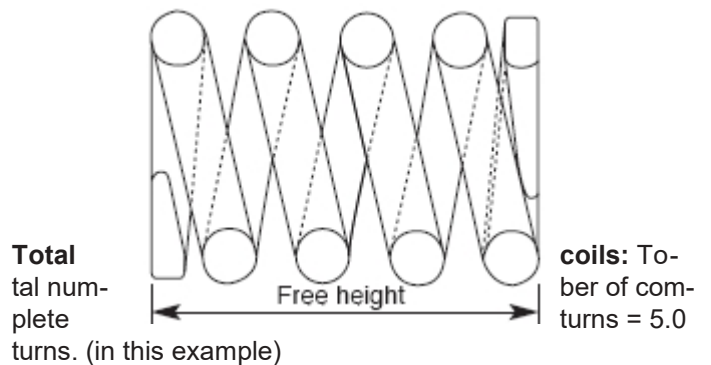

notes and advice in this catalogue.

INSTALLATION OF RAISED SUSPENSION SYSTEMS CAN INCREASE THE RISK OF VEHICLE ROLL OVER

Customer Specific Design and Spring Identification (Cont.)

Diameter of material: Use Vernier caliper to measure. Check at various points along coil and then check end coils as the diameter may vary.

Inside diameter (I.D): Use Vernier caliper to measure inside diameter of coil spring at both ends. Measure coil spring whilst out of vehicle.

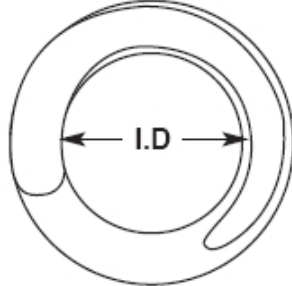

Spring end finish:

Normal: Unground, straight cut.

Ground: Ground flat

Reduced: End coil finishes smaller in diameter than main coils.

Fitting Guide

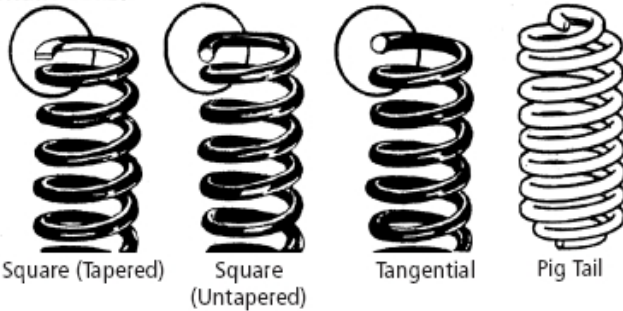

1. With vehicle on level (flat) ground, measure and record corner heights (E.B.H) from centre of rim to wheel arch.
2. With vehicle on flat ground measure and record static (working) height of O.E.M.(original) coils.(length of coil under load).
3. Lift vehicle and record trapped height of coil springs from front and rear. (wheels at full droop with springs and shocks still in vehicle).
4. Check inside diameter, top and bottom, of spring against O.E.M.(original) coils
5. Remove old suspension in accordance with vehicle manufacturers manual.
6. Reassemble new suspension components and fit to vehicle. Note: Final tensioning of all bolts & nuts to be done with suspension at normal ride height. Failure to observe this requirement may void any warranty.
7. Align vehicle to manufacturers specifications. Place vehicle on level ground and record final corner heights (E.B.H) from centre of rim to wheel arch.

Important: U-bolts must be checked regularly & retensioned.

For Maximum leaf spring life, after fitment of new leaf springs, U-bolts must be retensioned after 500klm with vehicle fully laden.

Lovells recommend all U-bolts to be checked regularly & retensioned if required. Torque settings are available upon request.

Glossary

Symbol	Description
All	All engine sizes within year of manufacturer
D	Diesel Powered Engines
P	Petrol Powered Engines
T	Turbo
□	Model on going
H/Top	Hard Top
S/Top	Soft Top
T/Back	Tray Back or Cab Chassis
P/Up	Pick Up or Utility
D/Cab	Dual Cab
Xtra Cab	King Cab
S/Rig	Spray Rig (suits vehicles with water tanks eg fire trucks etc)
M/Use	Mine Use
GVM	Gross Vehicle Mass Upgrade
MD	Medium Duty
XHD	Extra Heavy Duty
LWB	Long Wheel Base
SWB	Short Wheel

Catalogue Information

Information contained herein supersedes all previous catalogues. Information regarding vehicle specifications i.e. build dates, make & model & engine type have been sourced from industry accepted manuals, refer bibliography. Due to frequent vehicle production changes, no responsibility will be accepted by Lovells Springs Pty. Ltd. for any inaccuracies or variances of information contained in this catalogue.

Copyright

This catalogue may not be reproduced in whole or part without the written consent of Lovells Automotive Systems Pty. Ltd.

Trading Terms & Conditions

Refer www.lovells.com.au

Bibliography

The Red Book - Identification Manuals.

2025 Version 1

Page	Build dates	Kit Type	Vehicle	Suspension
Daihatsu				
5	12/74-6/84	B-C	F10,F20 (Petrol)	Leaf/Leaf
6	11/78-6/84	B-C	F50,F60 (Diesel)	Leaf/Leaf
7	11/79-6/84	B-C	F25,55P,65P Tray Back (Diesel)	Leaf/Leaf
8	10/88-9/93	B-C	Feroza F300	Torsion Bar/Leaf
9	10/93-5/98	B-C	Feroza F300 Wide Track	Torsion Bar/Leaf
10	10/93-5/98	B-C	Feroza F300 Narrow Track	Torsion Bar/Leaf
11	6/84-8/93	B-C	Rocky F70,75 Hard Top (Diesel)	Leaf/Leaf
12	11/86-6/93	B-C	Rocky F77R Tray Back (Diesel)	Leaf/Leaf
13	6/84-1/89	B-C	Rocky F80,F85 Hard Top (Petrol)	Leaf/Leaf
14	11/86-1/89	B-C	Rocky F87R Tray Back (Petrol)	Leaf/Leaf
Dodge				
15	7/20 on	A-B-C, GVM	Ram 1500 DS	Coil/Coil
16	7/20 on	GVM	Ram 1500 DS	Coil/Coil
17	7/20 on	GVM Platinum	Ram 1500 DS	Coil/Coil
Ford				
18	5/87-12/98	B-C	Courier PC,PD,PE 4x4	Torsion Bar/Leaf
19	01/15-7/18	B-C	Ford Everest Wagon	Coil/Coil
20	1/18-2/22	B-C	Ford Everest Wagon	Coil/Coil
21	1/18-2/22	GVM	Ford Everest Wagon	Coil/Coil
22	1/18-2/22	GVM Platinum	Ford Everest Wagon	Coil/Coil
23	3/22 on	GVM	Ford Everest Wagon	Coil/Coil
24	3/22 on	GVM Platinum	Ford Everest Wagon	Coil/Coil
25	3/88-3/94	A-B-C	Maverick Wagon LWB	Coil/Coil
26	3/88-3/94	A-B-C	Maverick Wagon SWB	Coil/Coil
27	3/88-3/94	B-C	Maverick Tray Back	Leaf/Leaf
28	1991-3/94	B-C	Maverick Tray Back	Coil/Coil
29	8/91-96	B-C	Raider UV Wagon	Torsion Bar/Leaf
30	12/06-12/11	B-C	Ranger PJ Super Cab Pick Up and Tray Back	Torsion Bar/Leaf
31	1/12-5/18	A-B-C-D	Ranger PXI & PX2 Pick Up and Tray Back	Coil/Leaf
32	1/12-5/18	GVM	Ranger PXI & PXII Pick Up and Tray Back	Coil/Leaf
33	1/17 on	GVM	Ranger 2WD PXII Pick Up and Tray Back	Coil/Leaf
34	6/18 on	A-B-C	Ranger PXIII Pick Up and Tray Back	Coil/Leaf
35	6/18 on	GVM	Ranger PXIII Pick Up and Tray Back	Coil/Leaf
36	3/22 on	A-B-C	Ranger GEN 3 PY Pick Up and Tray Back	Coil/Leaf
37	3/22 on	GVM Comfort	Ranger GEN 3 PY Pick Up and Tray Back	Coil/Leaf
38	3/22 on	GVM	Ranger GEN 3 PY Pick Up and Tray Back	Coil/Leaf
Holden				
39	8/08-5/12	A-B-C	Colorado RC Pick Up	Torsion Bar/Leaf
40	6/12-3/13	B-C and Platinum	Colorado RG Pick Up	Coil/Leaf
41	4/13 on	B-C and Platinum	Colorado RG Pick Up	Coil/Leaf
42	3/85-87	B-C	Drover QB Hard Top/Soft Top	Leaf/Leaf
43	11/81-86	B-C	Jackaroo UBS 13,16,52 Wagon SWB	Torsion Bar/Leaf
44	11/81-86	B-C	Jackaroo UBS 13,16,52 Wagon LWB	Torsion Bar/Leaf
45	11/86-91	B-C	Jackaroo UBS 16,17,52 Wagon SWB	Torsion Bar/Leaf
46	11/86-91	B-C	Jackaroo UBS 16,17,52 Wagon LWB	Torsion Bar/Leaf
47	5/92-1/98	B-C	Jackaroo UBS 25 Wagon SWB and LWB	Torsion Bar/Coil
48	2/98 on	B-C	Jackaroo UBS 26, 69, 73 Wagon SWB and LWB	Torsion Bar/Coil
49	7/85-2/03	B-C	Rodeo KB, KBD, TFS, R7, R9	Torsion Bar/Leaf
50	3/03 on	B-C	Rodeo RA Single Cab	Torsion Bar/Leaf
51	3/03 on	B-C	Rodeo RA Dual Cab	Torsion Bar/Leaf
Hyundai				
52	11/01 on	A-B-C	Terracan HP Wagon	Torsion Bar/Coil
Isuzu				
53	10/08-12/11	A-B-C	D Max MY09 Single Cab/Extra Cab	Torsion Bar/Leaf
54	10/08-12/11	A-B-C	D Max MY09 Dual Cab	Torsion Bar/Leaf
55	6/12-6/2020	A-B-C-M and Platinum	D Max MY12 Single Cab/Extra Cab/Dual Cab	Coil/Leaf
56	6/12-6/2020	GVM	D Max MY12 Single Cab/Extra Cab/Dual Cab	Coil/Leaf
57	7/2020 on	A-B-C-D	D Max MY21 Single Cab/Extra Cab/Dual Cab	Coil/Leaf
58	7/2020 on	GVM	D Max MY21 Single Cab/Extra Cab/Dual Cab	Coil/Leaf
59	7/2020 on	GVM Platinum	D Max MY21 Single Cab/Extra Cab/Dual Cab	Coil/Leaf
60	1/15-6/21	B-C	MU-X Wagon	Coil/Coil
61	7/21-on	B-C	MU-X Wagon	Coil/Coil
Jeep				
62	4/94-8/01	B	Cherokee Sport and Limited Wagon	Coil/Leaf
63	9/01-1/08	B-C	Cherokee KJ Wagon	Coil/Coil
64	2/08 on	B	Cherokee KK Wagon	Coil/Coil
65	1992-5/99	B	Grand Cherokee ZJ Wagon	Coil/Coil
66	6/99-12/10	A-B-C	Grand Cherokee WJ,WG,WH,WK Wagon	Coil/Coil
67	5/06 on	B-C	Commander XH Wagon	Coil/Coil
68	1986-9/96	B	Wrangler YJ	Leaf/Leaf
69	10/96-2/07	B	Wrangler TJ	Coil/Coil
70	3/07 on	B-C	Wrangler JK	Coil/Coil

Landrover

71	84 on	B-C	90 Series Wagon SWB	Coil/Coil
72	11/84-2/91	B-C	110 Series County Wagon LWB (Petrol)	Coil/Coil
73	11/84-2/91	B-C	110 Series County Wagon LWB (Diesel)	Coil/Coil
74	3/92 on	B-C	110 Series Defender Wagon/T- Back LWB (Diesel)	Coil/Coil
75	11/94-1/99	B-C	130 Series Crew Cab Tray Back LWB (Diesel)	Coil/Coil
76	2/99 on	B-C	110 Series Td5 Wagon LWB (Diesel)	Coil/Coil
77	4/91-3/99	A-B-C	Discovery JG Wagon	Coil/Coil
78	3/99-2/05	A-B-C	Discovery TG Wagon (Series II)	Coil/Coil
79	3/05 on	B	Discovery Series III Wagon	Coil/Coil
80	9/72-4/95	A-B-C	Range Rover Wagon	Coil/Coil

Mazda

81	3/88-10/02	A-B-C	B2600/Bravo Pick Up and Tray Back	Torsion Bar/Leaf
82	11/02-10/06	B-C	B2600/Bravo Pick Up and Tray Back	Torsion Bar/Leaf
83	11/06-9/11	B-C	BT50 Pick Up and Tray Back	Torsion Bar/Leaf
84	1/12-6/2020	A-B-C-D	BT50 MY12 Pick Up and Tray Back	Coil/Leaf
85	1/12-6/2020	GVM	BT50 MY12 Pick Up and Tray Back	Coil/Leaf
86	7/2020 on	A-B-C-D and Platinum	BT50 MY21 Pick Up and Tray Back	Coil/Leaf
87	7/2020 on	GVM	BT50 MY21 Pick Up and Tray Back	Coil/Leaf
88	7/2020 on	GVM Platinum	BT50 MY21 Pick Up and Tray Back	Coil/Leaf

Mitsubishi

89	3/98-8/00	B-C	Challenger PA Wagon	Torsion Bar/Leaf
90	9/00-10/03	A-B-C	Challenger PA (Series II) Wagon	Torsion Bar/Coil
91	12/09 on	B-C	Challenger KH Wagon	Coil/Coil
92	1/83-8/88	B-C	Pajero NA-NC Wagon SWB	Torsion Bar/Leaf
93	11/84-5/91	B-C	Pajero NB-NG Wagon LWB	Torsion Bar/Leaf
94	9/88-5/91	B-C	Pajero NF-NG Wagon LWB	Torsion Bar/Coil
95	5/91-4/00	B	Pajero NH,NJ,NK,NL Wagon SWB	Torsion Bar/Coil
96	5/91-4/00	A-B-C	Pajero NH,NJ,NK,NL Wagon LWB	Torsion Bar/Coil
97	5/00-10/02	A-B-C	Pajero NM Wagon LWB/SWB (Export)	Coil/Coil
98	11/02-7/08	A-B-C	Pajero NP,NS Wagon LWB (Petrol and Diesel)	Coil/Coil
99	8/08-9/12	A-B-C	Pajero NT Wagon LWB (Petrol and Diesel)	Coil/Coil
100	10/12 on	A-B-C	Pajero NW Wagon LWB (Petrol and Diesel)	Coil/Coil
101	10/86-8/96	B-C	Triton ME,MF,MG,MH,MJ Pick Up and Tray Back	Torsion Bar/Leaf
102	9/96-06	B-C	Triton MK-MY Pick Up and Tray Back	Torsion Bar/Leaf
103	7/06-10/15	B-C	Triton ML-MN Pick Up and Tray Back	Coil/Leaf
104	10/15 on	B-C	Triton MQ Pick Up and Tray Back	Coil/Leaf

Nissan

105	1/86-11/05	B-C	Navara D21/D22 Pick Up and Tray Back	Torsion Bar/Leaf
106	12/05-5/15	B-C	Navara D40 Pick Up 2.5D & 4.0 V6	Coil/Leaf
107	3/10-5/15	B	Navara D40 ST-X 550 Pick Up 3.0 V6	Coil/Leaf
108	6/15 on	B-C	NP300 Pick Up	Coil/Leaf
109	6/15 on	B-C	NP300 Pick Up	Coil/Coil
110	2/88-10/95	A-B-C	Pathfinder WD21 Wagon 2 door	Torsion Bar/Coil
111	11/95-11/98	A-B-C	Pathfinder R50 Wagon 2 door	Coil/Coil
112	11/95-11/98	A-B-C	Pathfinder R50 Wagon 4 door	Coil/Coil
113	11/01-6/05	A-B-C	Pathfinder R50 Wagon	Coil/Coil
114	7/05 on	A-B-C	Pathfinder R51 Wagon	Coil/Coil
115	6/80-3/83	B-C	Patrol MQ Wagon SWB and LWB	Leaf/Leaf
116	6/80-3/83	B-C	Patrol MQ Trayback (Petrol)	Leaf/Leaf
117	6/80-3/83	B-C	Patrol MQ Trayback (Diesel)	Leaf/Leaf
118	3/83-87	B-C	Patrol MK Wagon SWB and LWB (Petrol and Diesel)	Leaf/Leaf
119	3/83-87	B-C	Patrol MK Wagon LWB (Petrol and Diesel)	Leaf/Leaf
120	2/88-12/97	A-B-C	Patrol GQ Wagon SWB	Coil/Coil
121	2/88-12/97	A-B-C	Patrol GQ Wagon LWB	Coil/Coil
122	2/88-12/97	B-C	Patrol GQ Tray Back	Leaf/Leaf
123	2/88-12/97	A-B-C	Patrol GQ Tray Back	Coil/Leaf
124	2/88-12/97	A-B-C	Patrol GQ Tray Back	Coil/Coil
125	11/97 on	Progressive	Patrol Y61 GU Wagon LWB	Coil/Coil
126	11/97 on	Linear	Patrol Y61 GU Wagon LWB	Coil/Coil
127	11/97 on	Platinum	Patrol Y61 GU Wagon LWB	Coil/Coil
128	4/99 on	B-C	Patrol Y61 GU Tray Back	Coil/Coil
129	4/99 on	B-C	Patrol Y61 GU Tray Back	Coil/Leaf
130	4/99 on	GVM	Patrol Y61 GU Tray Back	Coil/Leaf
131	Tech Bulletin	CH0001	Patrol Y61 GU- Front ABS Spacer	
132	2012 on	A-B-C	Patrol Y62 Wagon LWB V8	Coil/Coil
133	3/97-4/00	B-C	Terrano II R20 Wagon	Torsion Bar/Coil

Ssangyong

134	8/96-2002	B	Musso Wagon	Torsion Bar/Coil
-----	-----------	---	-------------	------------------

Suzuki

135	10/98 on	A-B	Jimny SN413-JB33 Wagon	Coil/Coil
136	7/81-7/88	B-C	Sierra SJ40 Soft Top/Hard Top	Leaf/Leaf
137	7/81-7/88	B-C	Sierra SJ40 Tray Back	Leaf/Leaf
138	10/84-3/96	B-C	Sierra SJ50, SJ413 Soft Top and Hard Top	Leaf/Leaf
139	8/91-05	B	Vitara TD JXL Hard Top and Soft Top SWB, LWB Grand Vitara	Coil/Coil
140	8/01 on	B	Vitara XL7 Wagon (7 seater)	Coil/Coil

Toyota

141	2006 on	A-B-C	FJ Cruiser Wagon	Coil/Coil
142	7/84-10/85	A-B-C	4 Runner YN/LN60 Wagon (Petrol)	Leaf/Leaf
143	7/84-10/85	A-B-C	4 Runner YN/LN60 Wagon (Diesel)	Leaf/Leaf
144	11/85-5/89	B	4 Runner LN61/YN63 Wagon (Petrol and Diesel)	Torsion Bar/Leaf
145	10/89-6/96	A-B-C	4 Runner & Surf LN/RN130 Wagon (Petrol and Diesel)	Torsion Bar/Coil
146	1/15 on	B-C	Fortuner Wagon	Coil/Coil
147	1/79-7/83	A-B-C	Hilux RN36-46 (Petrol)	Leaf/Leaf
148	8/83-8/88	A-B-C	Hilux RN50 (Petrol)	Leaf/Leaf
149	8/83-12/97	A-B-C	Hilux RN36,46,105 (Petrol)	Leaf/Leaf
150	8/83-12/97	A-B-C	Hilux LN65,67,111 (Diesel)	Leaf/Leaf
151	8/88-12/97	B	Hilux LN111, RN110 (Petrol and Diesel)	Torsion Bar/Leaf
152	8/83-7/97	A-B-C	Hilux YN65, 67 (Petrol)	Leaf/Leaf
153	11/97-3/05	B	Hilux LN167RP, RZN167RT, RZN169RP and RT (Petrol and Diesel)	Torsion Bar/Leaf
154	1/98-3/05	B-C	Hilux LN172RC, RZN174 (Petrol and Diesel)	Torsion Bar/Leaf
155	3/05-9/15	B-C	Hilux GGN25R, KUN26R Single Cab (Petrol)	Coil/Leaf
156	3/05-9/15	B-C	Hilux GGN25R, KUN26R Single Cab (Diesel)	Coil/Leaf
157	3/05-9/15	B-C	Hilux GGN25R, KUN26R Dual Cab/Xtra Cab (Diesel)	Coil/Leaf
158	3/05-9/15	B-C	Hilux GGN25R, KUN26R Dual Cab/Xtra Cab (Diesel)	Coil/Leaf
159	3/05-9/15	GVM	Hilux GGN25R, KUN26R (150 Series) Single Cab, Dual Cab & Xtra Cab	Coil/Leaf
160	Tech Bulletin	LSPV001	Hilux Load Sensing Pressure Valve	
161	10/15 on	B-C	Hilux GUN126R Single Cab, Dual Cab, Extra Cab (Diesel)	Coil/Leaf
162	10/15 on	GVM	Hilux GUN126R Single Cab, Dual Cab, Extra Cab (Diesel)	Coil/Leaf
163	Tech Bulletin	CH002	Rear Brake Line Spacer	
164	Tech Bulletin	HLAR001	Headlight Potentiometer Link Adjustment	
165	10/15 on	GVM	Hilux 2WD (4x2) GEN 8 Dual Cab, Extra Cab	Coil/Leaf
166	3/59-7/80	B-C	Landcruiser 40 Series BJ, FJ, HJ40 SWB	Leaf/Leaf
167	8/80-4/86	B-C	Landcruiser 40,42,46 Series BJ,FJ40,BJ42,46 SWB	Leaf/Leaf
168	3/69-7/80	B-C	Landcruiser 45 Series FJ45, HJ45 Tray Back	Leaf/Leaf
169	3/69-7/80	B-C	Landcruiser 45 Series FJ45, HJ45 Troop Carrier	Leaf/Leaf
170	8/80-4/86	B-C	Landcruiser 45,47 Series FJ45, HJ47 Tray Back	Leaf/Leaf
171	8/80-4/86	B-C	Landcruiser 45,47 Series FJ45, HJ47 Troop Carrier	Leaf/Leaf
172	11/72-7/80	B-C	Landcruiser 55 Series FJ55 Wagon	Leaf/Leaf
173	8/80-6/87	A-B-C	Landcruiser 60 Series HJ60 Wag (Diesel)- 2H Engine non-turbo	Leaf/Leaf
174	7/87-2/89	B-C	Landcruiser 60 Series HJ60 Wag (Diesel)- 12H Engine Turbo	Leaf/Leaf
175	8/80-6/87	A-B-C	Landcruiser 60 Series FJ60 Wag (Petrol)- 2F Engine	Leaf/Leaf
176	7/87-2/89	B-C	Landcruiser 60 Series FJ60 Wag (Petrol)- 3F Engine	Leaf/Leaf
177	11/84-12/89	B-C	Landcruiser 70,73,74 Series BJ, FJ70,73,74 (Petrol and Diesel)	Leaf/Leaf
178	1/90-10/84	B-C	Landcruiser 70,73,77 Series HZJ77, PZJ70-73	Leaf/Leaf
179	11/84-12/89	B-C-Spary Rig	Landcruiser 75 Series BJ, FJ, HJ75 Pick Up/Tray Back and Troop Carrier	Leaf/Leaf
180	11/84-12/89	Mining	Landcruiser 75 Series BJ, FJ, HJ75 Pick Up /Tray Back and Troop Carrier	Leaf/Leaf
181	1/90-9/99	B-C	Landcruiser 75 Series FZJ, HZJ75 Tray Back (Petrol and Diesel)	Leaf/Leaf
182	1/90-9/99	B	Landcruiser 75 Series HZJ75 Troop Carrier (Diesel)	Leaf/Leaf
183	1/90-9/99	Spray Rig-Mining	Landcruiser 75 Series FZJ, HZJ75 Tray Back (Petrol and Diesel)	Leaf/Leaf
184	1/90-9/99	Mining	Landcruiser 75 Series FZJ, HZJ75 Troop Carrier (Diesel)	Leaf/Leaf
185	10/99-2/07	B-C	Landcruiser 78/79 Series FZJ, HZJ79 Tray Back (Petrol and Diesel)	Coil/Leaf
186	10/99-2/07	B-C	Landcruiser 78/79 Series FZJ, HZJ78 Troop Carrier (Petrol and Diesel)	Coil/Leaf
187	10/99-2/07	Spray Rig	Landcruiser 78/79 Series FZJ, HZJ79 Tray Back (Petrol and Diesel)	Coil/Leaf
188	10/99-2/07	Mining	Landcruiser 78/79 Series FZJ, HZJ79 Tray Back (Petrol and Diesel)	Coil/Leaf
189	10/99-2/07	Mining	Landcruiser 78/79 Series FZJ, HZJ78 Troop Carrier (Petrol and Diesel)	Coil/Leaf
190	10/99-2/07	GVM	Landcruiser 78/79 Series FZJ, HZJ79 Tray Back (Petrol and Diesel)	Coil/Leaf
191	10/99-2/07	GVM	Landcruiser 78/79 Series FZJ, HZJ78 Troop Carrier (Petrol and Diesel)	Coil/Leaf
192	9/2022 on	J7 GVM, GVM Plat 4200	Landcruiser 78 HZJ78 Troop Carrier (Diesel)	Coil/Leaf
193	3/07 on	B-C	Landcruiser 70 Series LC79 Tray Back (V8 Diesel)	Coil/Leaf
194	3/07 on	B-C	Landcruiser 70 Series LC78 Troop Carrier (V8 Diesel)	Coil/Leaf
195	3/07 on	A-B-C	Landcruiser 70 Series LC76 Wagon (V8 Diesel)	Coil/Leaf
196	3/07 on	Spray Rig	Landcruiser 70 Series LC79 Tray Back (V8 Diesel)	Coil/Leaf
197	3/07 on	Mining	Landcruiser 70 Series LC79 Tray Back (V8 Diesel)	Coil/Leaf
198	3/07 on	Mining	Landcruiser 70 Series LC78 Troop Carrier (V8 Diesel)	Coil/Leaf
199	3/07 on	GVM 3900	Landcruiser 70 Series LC79 Tray Back Single Cab	Coil/Leaf
200	3/07 on	GVM 3900	Landcruiser 70 Series LC79 Tray Back Dual Cab	Coil/Leaf
201	1/17 on	GVM 3900 Comfort	Landcruiser 70 Series LC79 Tray Back Single Cab/Dual Cab	Coil/Leaf
202	1/17 on	GVM 4200	Landcruiser 70 Series LC79 Tray Back Single Cab/Dual Cab	Coil/Leaf
203	1/17-8/22	GVM Platinum 4200	Landcruiser 70 Series LC79 Tray Back Single Cab	Coil/Leaf
204	1/17-8/22	BTC	Landcruiser 70 Series LC79 Tray Back Single Cab	Coil/Leaf
205	8/22 on	GVM Platinum 4200	Landcruiser 70 Series LC79 Tray Back Single/Dual Cab	Coil/Leaf
206	2/07 on	GVM 3900	Landcruiser 70 Series LC78 Troop Carrier (V8 Diesel)	Coil/Leaf
207	9/22 on	GVM 4200	Landcruiser 70 Series LC78 Troop Carrier (V8 Diesel) J7	Coil/Leaf
208	2/07 on	GVM	Landcruiser 70 Series LC76 4 Door Wagon (V8 Diesel)	Coil/Leaf
209	5/90-7/91	A-B-C	Landcruiser 80 Series FJ,HDJ80 Wagon (Petrol and Diesel)	Coil/Coil
210	8/91-2/98	Progressive	Landcruiser 80 Series FZJ, HZJ80 Wagon (Petrol and Diesel)	Coil/Coil
211	8/91-2/98	Linear	Landcruiser 80 Series FZJ, HZJ80 Wagon (Petrol and Diesel)	Coil/Coil
212	8/91-2/98	Platinum	FZJ, HZJ80 Wagon (Petrol and Diesel)	Coil/Coil
213	3/98-10/07	A-B-C	Landcruiser 100 Series UZJ105 Wagon (Petrol and Diesel)	Torsion Bar/Coil
214	3/98-10/07	Progressive	Landcruiser 100 Series FZJ, HZJ105 Wagon (Petrol and Diesel)	Coil/Coil
215	3/98-10/07	Linear	Landcruiser 100 Series FZJ, HZJ105 Wagon (Petrol and Diesel)	Coil/Coil
216	3/98-10/07	Platinum	Landcruiser 100 Series FZJ, HZJ105 Wagon (Petrol and Diesel)	Coil/Coil
217	09/07 on	A-B-C	Landcruiser 200 Series UZJ200 Wagon (Petrol)	Coil/Coil
218	09/07 on	A-B-C	Landcruiser 200 Series VDJ200 Wagon (Diesel)	Coil/Coil
219	09/07 on	GVM	Landcruiser 200 Series UZJ, VDJ200 Wagon (Petrol and Diesel)	Coil/Coil
220	09/07 on	GVM Platinum 4000	Landcruiser 200 Series UZJ, VDJ200 Wagon (Petrol and Diesel)	Coil/Coil
221	09/07 on	A-B-C-D-E-F	Landcruiser 200 Series UZJ, VDJ200 Wagon (Petrol and Diesel)	Coil/Coil
222	09/07 on	GVM Platinum 4200	Landcruiser 200 Series VDJ200 Wagon (Diesel)	Coil/Coil

Toyota Continued

223	Tech Bulletin
224	Tech Bulletin
225	11/07 on
226	07/21 on
227	07/21 on
228	07/21 on
229	07/21 on
230	07/21 on
231	7/96-12/02
232	2/03 on
233	2/03 on
234	2/03 on
235	2/03 on
236	10/09 on
237	10/09 on
238	10/09 on

Volkswagen

239	2/11-12/15
240	1/16 on

Kit Type

- A- STD Height
- B- Raised
- C- Raised H/Duty
- D- Raised Extra H/Duty

KDSS Adjust
KDSS Trim
BTC
A-B-C-D
A-B-C-D platinum
GVM Comfort
GVM
GVM Platinum
A-B-C
A-B-C
B-C
A-B-C
A-B-C
A-B-C
A-B-C
GVM

Landcruiser 200 Series KDSS Adjustment
Landcruiser 200 Series KDSS Trim and Fine Tuning
Landcruiser 200 Series UZJ, VDJ200 Wagon (Petrol and Diesel)
Landcruiser 300 Series J30T Wagon (Diesel)
Landcruiser 300 Series J30T Wagon (Diesel)
Landcruiser 300 Series J30T Wagon (Diesel)
Landcruiser 300 Series J30T Wagon (Diesel)
Landcruiser 300 Series J30T Wagon (Diesel)
Prado 90 Series RZJ, VZJ95 Wagon
Prado 120 Series Wagon LWB (Diesel 4 cyl.)
Prado 120 Series Wagon SWB (Diesel 4 cyl.)
Prado 120 Series Wagon LWB (Petrol 6 cyl.)
Prado 120 Series Wagon SWB (Petrol 6 cyl.) Export
Prado 150 Series Wagon LWB (Diesel 4 cyl.)
Prado 150 Series Wagon LWB
Prado 150 Series Wagon LWB

Coil/Coil
Coil/Coil
Coil/Coil
Coil/Coil
Coil/Coil
Coil/Coil
Coil/Coil
Coil/Coil
Coil/Coil
Coil/Coil
Coil/Coil
Coil/Coil
Coil/Coil
Coil/Coil

B-C
B-C

Volkswagen Amarok 2H Pick Up
Volkswagen Amarok Pick Up

Coil/Leaf
Coil/Leaf

- Mining-** Mine Site Vehicle Kits
- GVM-** Federal Compliance (Aust) Gross Vehicle Mass Upgrade
- GVM-ST- State** Compliance (Aust) Gross Vehicle Mass Upgrade

DAIHATSU- F SERIES
F10,F20 (Petrol)
12/74-6/84
Leaf/Leaf



KIT COMPONENTS

Item	Part No.	Qty. per vehicle	Description	List Price EACH
1	DU-1	2	Front Leaf Springs- Raised (B)	\$ 251.43
2	DU-1HD	2	Front Leaf Springs- Raised Heavy Duty (C)	\$ 302.83
3	DU-2	2	Rear Leaf Springs- Raised (B)	\$ 311.23
4	DU-2HD	2	Rear Leaf Springs- Raised Heavy Duty (C)	\$ 334.75
5	N72129	1	Front Urethane Bush Kit- Spring Front eye	\$ 80.87
6	N72129	1	Front Urethane Bush Kit- Spring Rear eye	\$ 80.87
7	N72128	1	Front Urethane Bush Kit- Spring Shackle	\$ 87.05
8	N72129	1	Rear Urethane Bush Kit- Spring Front eye	\$ 80.87
9	N72130	1	Rear Urethane Bush Kit- Spring Rear eye	\$ 72.09
10	N72128	1	Rear Urethane Bush Kit- Spring Shackle	\$ 87.05
11	UBL-24	1	Front Driver Side U-Bolt- Front of Spring	\$ 24.61
12	UBL-23	1	Front Driver Side U-Bolt- Rear of Spring	\$ 24.61
13	UBL-23	2	Front Passenger Side U-Bolts	\$ 24.61
14	UBL-23	4	Rear U-Bolts	\$ 24.61
15	64612111	2	Front Gas Legend Shock Absorber	\$ 244.03
16	64612111	2	Rear Gas Legend Shock Absorber	\$ 244.03

SUSPENSION KITS

Kit Type	Part No.	Qty. per vehicle	Kit Description	List Price EACH
B	DAKIT001-B	1	RAISED	\$ 2,787.09
C	DAKIT001-C	1	RAISED HEAVY DUTY	\$ 2,936.93

ACCESSORIES (Not included in Kit)

Item	Part No.	Qty. per vehicle	Accessory Description	List Price EACH
1A	N31062	2	Front Urethane Bush Kit- Shock Absorber	\$ 25.77

Part No.	Load Rating	Description
All spring load ratings are an approximate only. Vehicle ride heights will vary depending on load and accessories fitted.		
DU-1	0 to 60kg Constant Load	Suits Alloy and Steel Bull Bar
DU-1HD	0 to 120kg Constant Load	Suits Steel Bull Bar, Winch, Underbody Protection etc.
DU-2	0 to 60kg Constant Load	
DU-2HD	0 to 120kg Constant Load	

DAIHATSU- F SERIES
F50,F60 (Diesel)
11/78-6/84
Leaf/Leaf



KIT COMPONENTS

Item	Part No.	Qty. per vehicle	Description	List Price EACH
1	DU-3	2	Front Leaf Springs- Raised (B)	\$ 260.69
2	DU-3HD	2	Front Leaf Springs- Raised Heavy Duty (C)	\$ 285.83
3	DU-2	2	Rear Leaf Springs- Raised (B)	\$ 311.23
4	DU-2HD	2	Rear Leaf Springs- Raised Heavy Duty (C)	\$ 334.75
5	N72129	1	Front Urethane Bush Kit- Spring Front eye	\$ 80.87
6	N72129	1	Front Urethane Bush Kit- Spring Rear eye	\$ 80.87
7	N72128	1	Front Urethane Bush Kit- Spring Shackle	\$ 87.05
8	N72129	1	Rear Urethane Bush Kit- Spring Front eye	\$ 80.87
9	N72129	1	Rear Urethane Bush Kit- Spring Rear eye	\$ 80.87
10	N72128	1	Rear Urethane Bush Kit- Spring Shackle	\$ 87.05
11	UBL-24	1	Front Driver Side U-Bolt- Front of Spring	\$ 24.61
12	UBL-23	1	Front Driver Side U-Bolt- Rear of Spring	\$ 24.61
13	UBL-23	2	Front Passenger Side U-Bolts	\$ 24.61
14	UBL-23	4	Rear U-Bolts	\$ 24.61
15	64612111	2	Front Gas Legend Shock Absorber	\$ 244.03
16	64612111	2	Rear Gas Legend Shock Absorber	\$ 244.03

SUSPENSION KITS

Kit Type	Part No.	Qty. per vehicle	Kit Description	List Price EACH
B	DAIKIT002-B	1	RAISED	\$ 2,814.39
C	DAIKIT002-C	1	RAISED HEAVY DUTY	\$ 2,911.71

ACCESSORIES (Not included in Kit)

Item	Part No.	Qty. per vehicle	Accessory Description	List Price EACH
1A	N31062	2	Rear Urethane Bush Kit- Shock Absorber	\$ 25.77

Part No.	Load Rating	Description
All spring load ratings are an approximate only. Vehicle ride heights will vary depending on load and accessories fitted.		
DU-3	0 to 60kg Constant Load	Suits Alloy and Steel Bull Bar
DU-3HD	0 to 120kg Constant Load	Suits Steel Bull Bar, Winch, Underbody Protection etc.
DU-2	0 to 60kg Constant Load	
DU-2HD	0 to 120kg Constant Load	

DAIHATSU- F SERIES
F25,55P,65P Tray Back (Diesel)
11/79-6/84
Leaf/Leaf

KIT COMPONENTS

Item	Part No.	Qty. per vehicle	Description	List Price EACH
1	DU-7	2	Front Leaf Springs- Raised (B)	\$ 448.26
2	DU-7HD	2	Front Leaf Springs- Raised Heavy Duty (C)	\$ 334.75
3	DU-8	2	Rear Leaf Springs- Raised (B)	\$ 708.56
4	DU-8HD	2	Rear Leaf Springs- Raised Heavy Duty (C)	\$ 821.61
5	N72130	1	Front Urethane Bush Kit- Spring Front eye	\$ 72.09
6	N72129	1	Front Urethane Bush Kit- Spring Rear eye	\$ 80.87
7	N72128	1	Front Urethane Bush Kit- Spring Shackle	\$ 87.05
8	N72130	1	Rear Urethane Bush Kit- Spring Front eye	\$ 72.09
9	N72130	1	Rear Urethane Bush Kit- Spring Rear eye	\$ 72.09
10	N72128	1	Rear Urethane Bush Kit- Spring Shackle	\$ 87.05
11	UBL-24	1	Front Driver Side U-Bolt- Front of Spring	\$ 24.61
12	UBL-23	1	Front Driver Side U-Bolt- Rear of Spring	\$ 24.61
13	UBL-23	2	Front Passenger Side U-Bolts	\$ 24.61
14	UBL-23	4	Rear U-Bolts	\$ 24.61
15	64612111	2	Front Gas Legend Shock Absorber	\$ 244.03
16	64612638	2	Rear Gas Legend Shock Absorber	\$ 244.03

SUSPENSION KITS

Kit Type	Part No.	Qty. per vehicle	Kit Description	List Price EACH
B	DAIKIT003-B	1	RAISED	\$ 3,957.87
C	DAIKIT003-C	1	RAISED HEAVY DUTY	\$ 3,956.95

ACCESSORIES (Not included in Kit)

Item	Part No.	Qty. per vehicle	Accessory Description	List Price EACH
1A	N31062	2	Rear Urethane Bush Kit- Shock Absorber	\$ 25.77

Part No.	Load Rating	Description
All spring load ratings are an approximate only. Vehicle ride heights will vary depending on load and accessories fitted.		
DU-7	0 to 60kg Constant Load	Suits Alloy and Steel Bull Bar
DU-7HD	0 to 120kg Constant Load	Suits Steel Bull Bar, Winch, Underbody Protection etc.
DU-8	0 to 60kg Constant Load	
DU-8HD	0 to 120kg Constant Load	

DAIHATSU- Feroza (Sportrak- EXPORT)

F300

10/88-9/93

Torsion Bar/Leaf



KIT COMPONENTS

Item	Part No.	Qty. per vehicle	Description	List Price EACH
1	DAI007	1 Pair	Front Heavy Duty Torsion Bars	\$ 755.21
2	DU-9	2	Rear Leaf Springs- Raised (B)	\$ 488.22
3	DU-9HD	2	Rear Leaf Springs- Raised Heavy Duty (C)	\$ 571.42
4	N71863	1	Rear Urethane Bush Kit- Spring Front eye	\$ 74.14
5	N72167 (to 7/90 build date)	1	Rear Urethane Bush Kit- Spring Rear eye	\$ 94.06
6	N72130 (7/90 on build date)	1	Rear Urethane Bush Kit- Spring Rear eye	\$ 72.09
7	N72128	1	Rear Urethane Bush Kit- Spring Shackle	\$ 87.05
8	UBL-23	4	Rear U-Bolts	\$ 24.61
9	64612469S	2	Front Gas Legend Shock Absorber	\$ 227.70
10	64612639D	2	Rear Gas Legend Shock Absorber	\$ 244.03

SUSPENSION KITS

Kit Type	Part No.	Qty. per vehicle	Kit Description	List Price EACH
B	DAIKIT004-B	1	RAISED	\$ 3,028.80
C	DAIKIT004-C	1	RAISED HEAVY DUTY	\$ 3,195.20

ACCESSORIES (Not included in Kit)

Item	Part No.	Qty. per vehicle	Accessory Description	List Price EACH
1A	N21135	1	Front Urethane Bush Kit- Sway Bar Link	\$ 76.47
2A	N21058	1	Front Urethane Bush Kit- Sway Bar Mount	\$ 30.34
3A	N21173 (to 5/92 build date)	1	Front Urethane Bush Kit- Shock Absorber Upper	\$ 29.10
4A	N21173 (to 5/92 build date)	1	Rear Urethane Bush Kit- Shock Absorber Upper	\$ 29.10
5A	N21172 (5/92 on build date)	1	Rear Urethane Bush Kit- Shock Absorber Upper	\$ 29.58
6A	N31062 (5/92 on build date)	1	Rear Urethane Bush Kit- Shock Absorber Lower	\$ 24.09
7A	N21173 (5/92 on build date)	1	Rear Urethane Bush Kit- Shock Absorber Lower	\$ 29.10

Part No.	Load Rating	Description
All spring load ratings are an approximate only. Vehicle ride heights will vary depending on load and accessories fitted.		
DU-9	0 to 60kg Constant Load	
DU-9HD	0 to 120kg Constant Load	

DAIHATSU- Feroza (Sportrak- EXPORT)
F300 Wide Track
10/93-5/98
Torsion Bar/Leaf



KIT COMPONENTS

Item	Part No.	Qty. per vehicle	Description	List Price EACH
1	DAI007	1 Pair	Front Heavy Duty Torsion Bars	\$ 755.21
2	DU-10	2	Rear Leaf Springs- Raised (B)	\$ 502.85
3	DU-10HD	2	Rear Leaf Springs- Raised Heavy Duty (C)	\$ 535.61
4	N71863	1	Rear Urethane Bush Kit- Spring Front eye	\$ 74.14
5	N72130	1	Rear Urethane Bush Kit- Spring Rear eye	\$ 72.09
6	N72128	1	Rear Urethane Bush Kit- Spring Shackle	\$ 87.05
7	UBL-23	4	Rear U-Bolts	\$ 24.61
8	64612469S	2	Front Gas Legend Shock Absorber	\$ 227.70
9	64612077	2	Rear Gas Legend Shock Absorber	\$ 227.70

SUSPENSION KITS

Kit Type	Part No.	Qty. per vehicle	Kit Description	List Price EACH
B	DAIKIT005-B	1	RAISED	\$ 2,931.34
C	DAIKIT005-C	1	RAISED HEAVY DUTY	\$ 2,996.86

ACCESSORIES (Not included in Kit)

Item	Part No.	Qty. per vehicle	Accessory Description	List Price EACH
1A	N21135	1	Front Urethane Bush Kit- Sway Bar Link	\$ 76.47
2A	N21058	1	Front Urethane Bush Kit- Sway Bar Mount	\$ 30.34
3A	N21172	1	Rear Urethane Bush Kit- Shock Absorber Upper	\$ 31.65
4A	N21173	1	Rear Urethane Bush Kit- Shock Absorber Lower	\$ 36.81

Part No.	Load Rating	Description
All spring load ratings are an approximate only. Vehicle ride heights will vary depending on load and accessories fitted.		
DU-10	0 to 60kg Constant Load	
DU-10HD	0 to 120kg Constant Load	

DAIHATSU- Feroza (Sportrak- EXPORT)
F300 Narrow Track
10/93-5/98
Torsion Bar/Leaf



KIT COMPONENTS

Item	Part No.	Qty. per vehicle	Description	List Price EACH
1	DAI007	1 Pair	Front Heavy Duty Torsion Bars	\$ 755.21
2	DU-11	2	Rear Leaf Springs- Raised (B)	\$ 348.36
3	DU-11HD	2	Rear Leaf Springs- Raised Heavy Duty (C)	\$ 388.38
4	N71863	1	Rear Urethane Bush Kit- Spring Front eye	\$ 74.14
5	N72130	1	Rear Urethane Bush Kit- Spring Rear eye	\$ 72.09
6	N72128	1	Rear Urethane Bush Kit- Spring Shackle	\$ 87.05
7	UBL-23	4	Rear U-Bolts	\$ 24.61
8	64612469S	2	Front Gas Legend Shock Absorber	\$ 227.70
9	64612077	2	Rear Gas Legend Shock Absorber	\$ 227.70

SUSPENSION KITS

Kit Type	Part No.	Qty. per vehicle	Kit Description	List Price EACH
B	DAIKIT006-B	1	RAISED	\$ 2,622.36
C	DAIKIT006-C	1	RAISED HEAVY DUTY	\$ 2,702.40

ACCESSORIES (Not included in Kit)

Item	Part No.	Qty. per vehicle	Accessory Description	List Price EACH
1A	N21135	1	Front Urethane Bush Kit- Sway Bar Link	\$ 76.47
2A	N21058	1	Front Urethane Bush Kit- Sway Bar Mount	\$ 30.34
3A	N21172	1	Rear Urethane Bush Kit- Shock Absorber Upper	\$ 31.65
4A	N21173	1	Rear Urethane Bush Kit- Shock Absorber Lower	\$ 36.81

Part No.	Load Rating	Description
All spring load ratings are an approximate only. Vehicle ride heights will vary depending on load and accessories fitted.		
DU-11	0 to 60kg Constant Load	
DU-11HD	0 to 120kg Constant Load	

DAIHATSU- Rocky (Fourtrak/Taft- EXPORT)
F70,75 Hard Top (Diesel)
6/84-8/93
Leaf/Leaf



KIT COMPONENTS

Item	Part No.	Qty. per vehicle	Description	List Price EACH
1	DU-6	2	Front Leaf Springs- Raised (B)	\$ 414.89
2	DU-6HD	2	Front Leaf Springs- Raised Heavy Duty (C)	\$ 364.70
3	DU-5	2	Rear Leaf Springs- Raised (B)	\$ 502.84
4	DU-5HD	2	Rear Leaf Springs- Raised Heavy Duty (C)	\$ 548.56
5	N72167	2	Front Urethane Bush Kit- Spring Front/Rear eyes	\$ 94.06
6	N72128	1	Front Urethane Bush Kit- Spring Shackle	\$ 87.05
7	N72167	2	Rear Urethane Bush Kit- Spring Front/Rear eyes	\$ 94.06
8	N72128	1	Rear Urethane Bush Kit- Spring Shackle	\$ 87.05
9	UBL-24	1	Front Driver Side U-Bolt- Front of Spring	\$ 24.61
10	UBL-23	1	Front Driver Side U-Bolt- Rear of Spring	\$ 24.61
11	UBL-23	2	Front Passenger Side U-Bolts	\$ 24.61
12	UBL-23	4	Rear U-Bolts	\$ 24.61
13	64612639D	2	Front Gas Legend Shock Absorber	\$ 244.03
14	64612639D	2	Rear Gas Legend Shock Absorber	\$ 244.03

SUSPENSION KITS

Kit Type	Part No.	Qty. per vehicle	Kit Description	List Price EACH
B	DAIKIT007-B	1	RAISED	\$ 3,558.78
C	DAIKIT007-C	1	RAISED HEAVY DUTY	\$ 3,549.84

ACCESSORIES (Not included in Kit)

Item	Part No.	Qty. per vehicle	Accessory Description	List Price EACH
1A	N22107	1	Front Urethane Bush Kit- Sway Bar Link End	\$ 39.48
2A	N21047	1	Front Urethane Bush Kit- Sway Bar Mount	\$ 30.53
3A	N22107	1	Front Urethane Bush Kit- Sway Bar Outer	\$ 39.48
4A	N21172	1	Front Urethane Bush Kit- Shock Absorber Upper	\$ 31.65
5A	N31062	1	Front Urethane Bush Kit- Shock Absorber Lower	\$ 25.77
6A	N21173	1	Rear Urethane Bush Kit- Shock Absorber Upper	\$ 36.81
7A	N31062	1	Rear Urethane Bush Kit- Shock Absorber Lower	\$ 25.77

Note: Front stabiliser bar must be removed when fitting Lovells leaf springs to this vehicle.

Part No.	Load Rating	Description
All spring load ratings are an approximate only. Vehicle ride heights will vary depending on load and accessories fitted.		
DU-6	0 to 60kg Constant Load	Suits Alloy and Steel Bull Bar
DU-6HD	0 to 120kg Constant Load	Suits Steel Bull Bar, Winch, Underbody Protection etc.
DU-5	0 to 60kg Constant Load	
DU-5HD	0 to 120kg Constant Load	

DAIHATSU- Rocky (Fourtrak/Taft- EXPORT)
F77R Tray Back (Diesel)
11/86-6/93
Leaf/Leaf

KIT COMPONENTS

Item	Part No.	Qty. per vehicle	Description	List Price EACH
1	DU-7	2	Front Leaf Springs- Raised (B)	\$ 448.26
2	DU-7HD	2	Front Leaf Springs- Raised Heavy Duty (C)	\$ 334.75
3	DU-8	2	Rear Leaf Springs- Raised (B)	\$ 708.56
4	DU-8HD	2	Rear Leaf Springs- Raised Heavy Duty (C)	\$ 821.61
5	N72167	2	Front Urethane Bush Kit- Spring Front/Rear eyes	\$ 94.06
6	N72128	1	Front Urethane Bush Kit- Spring Shackle	\$ 87.05
7	N72130	2	Rear Urethane Bush Kit- Spring Front/Rear eyes	\$ 72.09
8	Not Available	0	Rear Urethane Bush Kit- Spring Shackle	
9	UBL-24	1	Front Driver Side U-Bolt- Front of Spring	\$ 24.61
10	UBL-23	1	Front Driver Side U-Bolt- Rear of Spring	\$ 24.61
11	UBL-23	2	Front Passenger Side U-Bolts	\$ 24.61
12	UBL-23	4	Rear U-Bolts	\$ 24.61
13	64612639D	2	Front Gas Legend Shock Absorber	\$ 244.03
14	64612638	2	Rear Gas Legend Shock Absorber	\$ 244.03

SUSPENSION KITS

Kit Type	Part No.	Qty. per vehicle	Kit Description	List Price EACH
B	DAIKIT008-B	1	RAISED	\$ 3,905.98
C	DAIKIT008-C	1	RAISED HEAVY DUTY	\$ 3,905.06

ACCESSORIES (Not included in Kit)

Item	Part No.	Qty. per vehicle	Accessory Description	List Price EACH
1A	N22107	1	Front Urethane Bush Kit- Sway Bar Link End	\$ 39.48
2A	N21047	1	Front Urethane Bush Kit- Sway Bar Mount	\$ 30.53
3A	N22107	1	Front Urethane Bush Kit- Sway Bar Outer	\$ 39.48
4A	N21172	1	Front Urethane Bush Kit- Shock Absorber Upper	\$ 31.65
5A	N31062	1	Front Urethane Bush Kit- Shock Absorber Lower	\$ 25.77
6A	N21172	1	Rear Urethane Bush Kit- Shock Absorber Upper	\$ 31.65
7A	N31062	1	Rear Urethane Bush Kit- Shock Absorber Lower	\$ 25.77

Note: Front stabiliser bar must be removed when fitting Lovells leaf springs to this vehicle.

Part No.	Load Rating	Description
All spring load ratings are an approximate only. Vehicle ride heights will vary depending on load and accessories fitted.		
DU-7	0 to 60kg Constant Load	Suits Alloy and Steel Bull Bar
DU-7HD	0 to 120kg Constant Load	Suits Steel Bull Bar, Winch, Underbody Protection etc.
DU-8	0 to 60kg Constant Load	
DU-8HD	0 to 120kg Constant Load	

DAIHATSU- Rocky (Fourtrak/Taft- EXPORT)
F80,F85 Hard Top (Petrol)
6/84-1/89
Leaf/Leaf

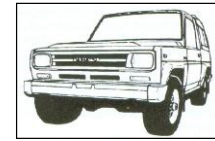

KIT COMPONENTS

Item	Part No.	Qty. per vehicle	Description	List Price EACH
1	DU-4	2	Front Leaf Springs- Raised (B)	\$ 365.70
2	DU-4HD	2	Front Leaf Springs- Raised Heavy Duty (C)	\$ 457.13
3	DU-5	2	Rear Leaf Springs- Raised (B)	\$ 502.84
4	DU-5HD	2	Rear Leaf Springs- Raised Heavy Duty (C)	\$ 548.56
5	N72167	2	Front Urethane Bush Kit- Spring Front/Rear eyes	\$ 94.06
6	N72128	1	Front Urethane Bush Kit- Spring Shackle	\$ 87.05
7	N72130	2	Rear Urethane Bush Kit- Spring Front/Rear eyes	\$ 72.09
8	N72128	1	Rear Urethane Bush Kit- Spring Shackle	\$ 87.05
9	UBL-24	1	Front Driver Side U-Bolt- Front of Spring	\$ 24.61
10	UBL-23	1	Front Driver Side U-Bolt- Rear of Spring	\$ 24.61
11	UBL-23	2	Front Passenger Side U-Bolts	\$ 24.61
12	UBL-23	4	Rear U-Bolts	\$ 24.61
13	64612639D	2	Front Gas Legend Shock Absorber	\$ 244.03
14	64612639D	2	Rear Gas Legend Shock Absorber	\$ 244.03

SUSPENSION KITS

Kit Type	Part No.	Qty. per vehicle	Kit Description	List Price EACH
B	DAIKIT009-B	1	RAISED	\$ 3,416.46
C	DAIKIT009-C	1	RAISED HEAVY DUTY	\$ 3,690.76

ACCESSORIES (Not included in Kit)

Item	Part No.	Qty. per vehicle	Accessory Description	List Price EACH
1A	N22107	1	Front Urethane Bush Kit- Sway Bar Link End	\$ 39.48
2A	N21047	1	Front Urethane Bush Kit- Sway Bar Mount	\$ 30.53
3A	N22107	1	Front Urethane Bush Kit- Sway Bar Outer	\$ 39.48
4A	N21172	1	Front Urethane Bush Kit- Shock Absorber Upper	\$ 31.65
5A	N31062	1	Front Urethane Bush Kit- Shock Absorber Lower	\$ 25.77
6A	N21173	1	Rear Urethane Bush Kit- Shock Absorber Upper	\$ 36.81
7A	N31062	1	Rear Urethane Bush Kit- Shock Absorber Lower	\$ 25.77

Note: Front stabiliser bar must be removed when fitting Lovells leaf springs to this vehicle.

Part No.	Load Rating	Description
All spring load ratings are an approximate only. Vehicle ride heights will vary depending on load and accessories fitted.		
DU-4	0 to 60kg Constant Load	Suits Alloy and Steel Bull Bar
DU-4HD	0 to 120kg Constant Load	Suits Steel Bull Bar, Winch, Underbody Protection etc.
DU-5	0 to 60kg Constant Load	
DU-5HD	0 to 120kg Constant Load	

Dodge
Ram 1500 DS Gen 4
7/20 on
Coil/Coil

KIT COMPONENTS

Item	Part No.	Qty. per vehicle	Description	List Price EACH
1	DFR-150	2	Front Coil Springs- Raised (A)	\$ 126.26
2	DFR-150HD	2	Front Coil Springs- Heavy Duty (B&C)	\$ 134.70
3	DRR-151	2	Rear Coil Springs- Raised (A)	\$ 126.26
4	DRR-151HD	2	Rear Coil Springs- Heavy Duty (B)	\$ 126.26
5	DRR-151EHD	2	Rear Coil Springs- Raised Extra Heavy Duty (C)	\$ 126.26
6	64611050	2	Front Gas Legend Strut	\$ 327.79
7	64611051	2	Rear Gas Legend Shock Absorber	\$ 261.67

SUSPENSION KITS

Kit Type	Part No.	Qty. per vehicle	Kit Description	Retail Price
A	RAMKIT001-A	1	RAISED	\$ 1,683.95
B	RAMKIT001-B	1	RAISED HEAVY DUTY	\$ 1,700.84
C	RAMKIT001-C	1	RAISED EXTRA HEAVY DUTY	\$ 1,700.84

Optional parts

Item	Part No.	Qty. per vehicle	Option Description	List Price EACH
1A	LOVUCA-RAM	1	Lovells Extreme Upper Control Arm kit	\$ 920.00

Part No.	Load Rating	Description
All spring load ratings are an approximate only. Vehicle ride heights will vary depending on load and accessories fitted.		
DFR-150	0 to 100kg Constant Load	Suits Steel Bull Bar
DFR-150HD	100 to 150kg Constant Load	Suits Steel Bull Bar, Winch, Underbody Protection etc.
DRR-151	0 to 100kg Constant Load	
DRR-151HD	100 to 150kg Constant Load	
DRR-151EHD	150 to 300kg Constant Load	

Dodge
Ram 1500 DS Gen 4
7/20 on
Coil/Coil

3950KG GVM Upgrade Kit (Fitted Price)

KIT COMPONENTS

Item	Part No.	Qty. per vehicle	Description	SOLD AS KIT ONLY
1	DFR-150	2	Front Coil Springs- Raised	
Vehicles with minimal or no load bearing front accessories. Axle Capacities under 1700kg				
OR				
2	DFR-150HD	2	Front Coil Springs- Heavy Duty	
Vehicles load bearing front accessories eg. Steel bull bar/winch/side steps. Axle capacities between 1700kg and 1870kg				
3	DRR-151HD	2	Rear Coil Springs- Heavy Duty	
Vehicles with variable loads. Axle Capacities under 1350kg.				
OR				
4	DRR-151EHD	2	Rear Coil Springs- Extra Heavy Duty	
Vehicles with constant load and towing applications. Axle Capacities between 1350kg and 2080kg.				
5	64611050	2	Front Gas Legend Strut	
6	64611051	2	Rear Gas Legend Shock Absorber	
7	77ACMB-LCRUISER70-GVM-IND	2	Category 6 Indicators ADR13/00	
8		1	3950kg SVI (Compliance Plate)	
9		1	3950kg Tyre Loading Placard (decal)	
10		2	Lovells Mudflaps to comply to ADR42/04	
11		1	Certificate of Compliance & Owners manual	
12		1	GVM Upgrade Fitting Instructions	

SUSPENSION KITS

Kit Type	Part No.	Qty. per vehicle	Kit Description	Retail Price
GVM	RAMKIT001-GVM	1	GVM Upgrade Kit (Fitted Price)	\$ 4,400.00

NOTE: Fitted Price plus GST

Optional parts

Item	Part No.	Qty. per vehicle	Option Description	List Price EACH
1A	LOVUCA-RAM	1	Lovells Extreme Upper Control Arm kit	\$ 920.00

Part No.	Load Rating	Description
All spring load ratings are an approximate only. Vehicle ride heights will vary depending on load and accessories fitted.		
DFR-150	0 to 100kg Constant Load	Suits Steel Bull Bar
DFR-150HD	100 to 150kg Constant Load	Suits Steel Bull Bar, Winch, Underbody Protection etc.
DRR-151HD	100 to 150kg Constant Load	To GVM
DRR-151EHD	150 to 300kg Constant Load	To GVM

Dodge
Ram 1500 DS Gen 4
7/20 on
Coil/Coil



3950KG GVM Upgrade Kit (Fitted Price)

KIT COMPONENTS

Item	Part No.	Qty. per vehicle	Description	SOLD AS KIT ONLY
1	DFR-150	2	Front Coil Springs- Raised	
Vehicles with minimal or no load bearing front accessories. Axle Capacities under 1700kg				
OR				
2	DFR-150HD	2	Front Coil Springs- Heavy Duty	
Vehicles load bearing front accessories eg. Steel bull bar/winch/side steps. Axle capacities between 1700kg and 1870kg				
3	DRR-151HD	2	Rear Coil Springs- Heavy Duty	
Vehicles with variable loads. Axle Capacities under 1350kg.				
OR				
4	DRR-151EHD	2	Rear Coil Springs- Extra Heavy Duty	
Vehicles with constant load and towing applications. Axle Capacities between 1350kg and 2080kg.				
5	64611050-2.0ADJMONO	2	Front 2.0" Mono Tube Strut with Remote Reservoir	
6	64611051SR-2.0ADJMONO	1	Rear 2.0" Mono Tube Shock with Remote Reservoir	
7	64611051SL-2.0ADJMONO	1	Rear 2.0" Mono Tube Shock with Remote Reservoir	
8	77ACMB-LCRUISER70-GVM-IND	2	Category 6 Indicators ADR13/00	
9		1	3950kg SVI (Compliance Plate)	
10		1	3950kg Tyre Loading Placard (decal)	
11		2	Lovells Mudflaps to comply to ADR42/04	
12		1	Certificate of Compliance & Owners manual	
13		1	GVM Upgrade Fitting Instructions	

SUSPENSION KITS

Kit Type	Part No.	Qty. per vehicle	Kit Description	Retail Price
GVM	RAMKIT002-GVM-PLAT	1	GVM Upgrade Kit (Fitted Price)	\$ 5,550.00

NOTE: Fitted Price plus GST

Optional parts

Item	Part No.	Qty. per vehicle	Option Description	List Price EACH
1A	LOVUCA-RAM	1	Lovells Extreme Upper Control Arm kit	\$ 920.00

Part No.	Load Rating	Description
All spring load ratings are an approximate only. Vehicle ride heights will vary depending on load and accessories fitted.		
DFR-150	0 to 100kg Constant Load	Suits Steel Bull Bar
DFR-150HD	100 to 150kg Constant Load	Suits Steel Bull Bar, Winch, Underbody Protection etc.
DRR-151HD	100 to 150kg Constant Load	To GVM
DRR-151EHD	150 to 300kg Constant Load	To GVM

FORD- Courier (Ranger- EXPORT)
PC,PD,PE 4x4
5/87-12/98
Torsion Bar/Leaf



KIT COMPONENTS

Item	Part No.	Qty. per vehicle	Description	List Price EACH
1	MAZDA005	1 Pair	Front Heavy Duty Torsion Bars	\$ 530.35
2	MR-26	2	Rear Leaf Springs- Raised (B)	\$ 615.05
3	MR-26HD	2	Rear Leaf Springs- Raised Heavy Duty (C)	\$ 644.33
4	N72065	1	Rear Urethane Bush Kit- Spring Front eye	\$ 88.74
5	N71136	1	Rear Urethane Bush Kit- Spring Rear eye	\$ 47.33
6	N71215	1	Rear Urethane Bush Kit- Spring Shackle	\$ 60.24
7	UBL-18	4	Rear U-Bolts	\$ 24.61
8	LGSKMAZ-001	2	Rear Greasable Shackle	\$ 53.93
9	LGPKFD-004	2	Rear Greasable Pin	\$ 66.88
10	6462543P	2	Front Gas Legend Shock Absorber	\$ 244.03
11	6462525T	2	Rear Gas Legend Shock Absorber	\$ 268.60

SUSPENSION KITS

Kit Type	Part No.	Qty. per vehicle	Kit Description	List Price EACH
B	FORDKIT001-B	1	RAISED	\$ 3,322.07
C	FORDKIT001-C	1	RAISED HEAVY DUTY	\$ 3,380.63

ACCESSORIES (Not included in Kit)

Item	Part No.	Qty. per vehicle	Accessory Description	List Price EACH
1A	N11421	1	Front Urethane Bush Kit- Steering Idler Bush	\$ 35.89
2A	N31207	1	Front Urethane Bush Kit- Sway Bar Link	\$ 52.86
3A	N21058	1	Front Urethane Bush Kit- Sway Bar Mount	\$ 30.34
4A	N21172	1	Front Urethane Bush Kit- Shock Absorber Upper	\$ 31.65

Part No.	Load Rating	Description
All spring load ratings are an approximate only. Vehicle ride heights will vary depending on load and accessories fitted.		
MR-26	0 to 100kg Constant Load	
MR-26HD	100 to 250kg Constant Load	

FORD- Everest
Wagon
01/15-7/18
Coil/Coil

KIT COMPONENTS

Item	Part No.	Qty. per vehicle	Description	List Price EACH
1	FFR-90	2	Front Coil Springs- Raised (B)	\$ 126.26
2	FFR-90HD	2	Front Coil Springs- Raised Heavy Duty (C)	\$ 126.26
3	FRR-115	2	Rear Coil Springs- Raised (B)	\$ 149.68
4	FRR-115HD	2	Rear Coil Springs- Raised Heavy Duty (C)	\$ 165.51
5	64611037	2	Front Gas Legend Strut	\$ 331.67
6	64611047	2	Rear Gas Legend Shock Absorber	\$ 244.03

SUSPENSION KITS

Kit Type	Part No.	Qty. per vehicle	Kit Description	List Price EACH
B	FORDKIT010-B	1	RAISED	\$ 1,703.28
C	FORDKIT010-C	1	RAISED HEAVY DUTY	\$ 1,734.93

ACCESSORIES (Not included in Kit)

Item	Part No.	Qty. per vehicle	Accessory Description	List Price EACH
1A	T SMAZ-001	1	Drive Shaft Spacer Kit	\$ 94.15

Part No.	Load Rating	Description
All spring load ratings are an approximate only. Vehicle ride heights will vary depending on load and accessories fitted.		
FFR-90	0 to 100kg Constant Load	Suits Steel Bull Bar
FFR-90HD	100 to 150kg Constant Load	Suits Steel Bull Bar, Winch, Underbody Protection etc.
FRR-115	0 to 100kg Constant Load	
FRR-115HD	150 to 250kg Constant Load	

FORD- Everest
Wagon
1/18-2/22
Coil/Coil

KIT COMPONENTS

Item	Part No.	Qty. per vehicle	Description	List Price EACH
1	FFR-91	2	Front Coil Springs- Raised (B)	\$ 126.26
2	FFR-91HD	2	Front Coil Springs- Raised Heavy Duty (C)	\$ 126.26
3	FRR-115	2	Rear Coil Springs- Raised (B)	\$ 149.68
4	FRR-115HD	2	Rear Coil Springs- Raised Heavy Duty (C)	\$ 165.51
5	64611049	2	Front Gas Legend Strut	\$ 335.22
6	64611047	2	Rear Gas Legend Shock Absorber	\$ 244.03

SUSPENSION KITS

Kit Type	Part No.	Qty. per vehicle	Kit Description	List Price EACH
B	FORDKIT013-B	1	RAISED	\$ 1,710.38
C	FORDKIT013-C	1	RAISED HEAVY DUTY	\$ 1,742.03

ACCESSORIES (Not included in Kit)

Item	Part No.	Qty. per vehicle	Accessory Description	List Price EACH
1A	T SMAZ-001	1	Drive Shaft Spacer Kit	\$ 94.15

Part No.	Load Rating	Description
All spring load ratings are an approximate only. Vehicle ride heights will vary depending on load and accessories fitted.		
FFR-91	0 to 100kg Constant Load	Suits Steel Bull Bar
FFR-91HD	100 to 150kg Constant Load	Suits Steel Bull Bar, Winch, Underbody Protection etc.
FRR-115	0 to 100kg Constant Load	
FRR-115HD	150 to 250kg Constant Load	

FORD- Everest
Wagon
1/18-2/22
Coil/Coil

3500KG GVM Upgrade Kit (Fitted Price)

KIT COMPONENTS

Item	Part No.	Qty. per vehicle	Description	SOLD AS KIT ONLY
1	FFS-91	2	Front Coil Springs	
Vehicles with minimal or no load bearing front accessories. Axle Capacities under 1300kg				
OR				
2	FFR-91	2	Front Coil Springs- Raised	
Vehicles load bearing front accessories eg. Steel bull bar/winch/side steps. Axle capacities between 1300kg and 1580kg				
3	FRR-115	2	Rear Coil Springs- Raised	
Vehicles with variable loads. Axle Capacities under 1350kg.				
OR				
4	FRR-115HD	2	Rear Coil Springs- Heavy Duty	
Vehicles with constant load and towing applications. Axle Capacities between 1350kg and 2020kg.				
5	64611049	2	Front Gas Legend Strut	
6	64611047	2	Rear Gas Legend Shock Absorber	
7		1	3500kg SVI (Compliance Plate)	
8		1	3500kg Tyre Loading Placard (decal)	
9		2	Lovells Mudflaps to comply to ADR42/04	
10		1	Certificate of Compliance & Owners manual	
11		1	GVM Upgrade Fitting Instructions	

SUSPENSION KITS

Kit Type	Part No.	Qty. per vehicle	Kit Description	Retail Price
GVM	FORDKIT014-GVM	1	GVM Upgrade Kit (Fitted Price)	\$ 3,900.00

ACCESSORIES (Not included in Kit)

Item	Part No.	Qty. per vehicle	Accessory Description	List Price EACH
1A	TSTMAZ-001	1	Drive Shaft Spacer Kit	\$ 94.15

Part No.	Load Rating	Description
All spring load ratings are an approximate only. Vehicle ride heights will vary depending on load and accessories fitted.		
FFS-91	0 to 100kg Constant Load	Suits Steel Bull Bar
FFR-91	100 to 150kg Constant Load	Suits Steel Bull Bar, Winch, Underbody Protection etc.
FRR-115	0 to 100kg Constant Load	To GVM
FRR-115HD	150 to 250kg Constant Load	To GVM

*****NOTE:** The above GVM Upgrade Kit for Federal Compliance under Second Stage Manufacturer Approval, with a Federal compliance plate, is no longer available
 The above kit can still be supplied under State Compliance and will require inspection, by a Lovells endorsed signatory and /or Production Facility.
 Consult your nearest Lovells Production facility for Individual State requirements.

FORD- Everest
Wagon
1/18-2/22
Coil/Coil



3500KG GVM Upgrade Kit (Fitted Price)

KIT COMPONENTS

Item	Part No.	Qty. per vehicle	Description	SOLD AS KIT ONLY
1	FFS-91	2	Front Coil Springs	
Vehicles with minimal or no load bearing front accessories. Axle Capacities under 1300kg				
OR				
2	FFR-91	2	Front Coil Springs- Raised	
Vehicles load bearing front accessories eg. Steel bull bar/winch/side steps. Axle capacities between 1300kg and 1580kg				
3	FRR-115	2	Rear Coil Springs- Raised	
Vehicles with variable loads. Axle Capacities under 1350kg.				
OR				
4	FRR-115HD	2	Rear Coil Springs- Heavy Duty	
Vehicles with constant load amd towing applications. Axle Capacities between 1350kg and 2020kg.				
5	64611049LH-2.0ADJMONO	1	Front 2.0" Mono Tube Strut with Remote Reservoir	
6	64611049RH-2.0ADJMONO	1	Front 2.0" Mono Tube Strut with Remote Reservoir	
7	64611047-2.0ADJMONO	2	Rear 2.0" Mono Tube Shock with Remote Reservoir	
8		1	3500kg SVI (Compliance Plate)	
9		1	3500kg Tyre Loading Placard (decal)	
10		2	Lovells Mudflaps to comply to ADR42/04	
11		1	Certificate of Compliance & Owners manual	
12		1	GVM Upgrade Fitting Instructions	

SUSPENSION KITS

Kit Type	Part No.	Qty. per vehicle	Kit Description	Retail Price
GVM	FORDKIT015-GVM-PLAT	1	GVM Upgrade Kit (Fitted Price)	\$ 5,550.00

NOTE: Fitted Price plus GST

Part No.	Load Rating	Description
All spring load ratings are an approximate only. Vehicle ride heights will vary depending on load and accessories fitted.		
FFS-91	0 to 100kg Constant Load	Suits Steel Bull Bar
FFR-91	100 to 150kg Constant Load	Suits Steel Bull Bar, Winch, Underbody Protection etc.
FRR-115	0 to 100kg Constant Load	To GVM
FRR-115HD	150 to 250kg Constant Load	To GVM

*****NOTE: The above GVM Upgrade Kit for Federal Compliance under Second Stage Manufacturer Approval, with a Federal compliance plate, is no longer available
The above kit can still be supplied under State Compliance and will require inspection, by a Lovells endorsed signatory and /or Production Facility.
Consult your nearest Lovells Production facility for Individual State requirements.**

FORD- Everest
4WD Wagon Diesel Only
3/22 on
Coil/Coil

GVM Upgrade Kit (Fitted Price)-Federal Compliance
3500kg

KIT COMPONENTS

Item	Part No.	Qty. per vehicle	Description	SOLD AS KIT ONLY
1	FFS-92	2	Front Coil Springs	
Vehicles with minimal or no load bearing front accessories. Axle Capacities under 1400kg				
OR				
2	FFR-92	2	Front Coil Springs- Raised	
Vehicles load bearing front accessories eg. Steel bull bar/winch/side steps.				
3	FRR-115HD	2	Rear Coil Springs- Raised	
Vehicles with variable loads. Axle Capacities under 1400kg.				
OR				
4	FRR-115EHD	2	Rear Coil Springs- Heavy Duty	
Vehicles with constant load and towing applications. Axle Capacities between 1400kg and 1960kg.				
5	64612587	2	Front Gas Legend Strut	
6	64611047	2	Rear Gas Legend Shock Absorber	
7		1	3500kg SVI (Compliance Plate)	
8		1	3500kg Tyre Loading Placard (decal)	
9		2	Lovells Mudflaps to comply to ADR42/04	
10		1	Certificate of Compliance & Owners manual	
11		1	GVM Upgrade Fitting Instructions	

SUSPENSION KITS

Kit Type	Part No.	Qty. per vehicle	Kit Description	Retail Price
GVM	FORDKIT017-GVM	1	GVM Upgrade Kit (Fitted Price)	\$ 4,400.00
GVM	FORDKIT017-GVM-EHD	1	GVM Upgrade Kit (Fitted Price) Heavy Duty Rear Springs	\$ 4,400.00

NOTE: Fitted Price plus GST

Optional parts

Item	Part No.	Qty. per vehicle	Accessory Description	List Price EACH
1A	LOVUCA-FR22	1	Lovells Extreme Upper Control Arm kit	\$ 995.00

Part No.	Load Rating	Description
All spring load ratings are an approximate only. Vehicle ride heights will vary depending on load and accessories fitted.		
FFS-92	0 to 100kg Constant Load	Suits Steel Bull Bar
FFR-92	100 to 150kg Constant Load	Suits Steel Bull Bar, Winch, Underbody Protection etc.
FRR-115HD	150 to 250kg Constant Load	To GVM
FRR-115EHD	250 to 300kg Constant Load	To GVM

FORD- Everest
4WD Wagon Diesel Only
3/22 on
Coil/Coil



GVM Upgrade Kit (Fitted Price)-Federal Compliance
3700kg

KIT COMPONENTS

Item	Part No.	Qty. per vehicle	Description	SOLD AS KIT ONLY
1	FFS-92	2	Front Coil Springs	
Vehicles with minimal or no load bearing front accessories. Axle Capacities under 1400kg				
OR				
2	FFR-92	2	Front Coil Springs- Raised	
Vehicles load bearing front accessories eg. Steel bull bar/winch/side steps.				
3	FRR-115HD	2	Rear Coil Springs- Raised	
Vehicles with variable loads. Axle Capacities under 1400kg.				
OR				
4	FRR-115EHD	2	Rear Coil Springs- Heavy Duty	
Vehicles with constant load and towing applications. Axle Capacities between 1400kg and 1960kg.				
5	64612587FL-2.0ADJMONO	1	Front 2.0" Mono Tube Strut with Remote Reservoir	
6	64612587FR-2.0ADJMONO	1	Front 2.0" Mono Tube Strut with Remote Reservoir	
7	64611047-2.0ADJMONO	2	Rear 2.0" Mono Tube Shock with Remote Reservoir	
8		1	3500kg SVI (Compliance Plate)	
9		1	3500kg Tyre Loading Placard (decal)	
10		2	Lovells Mudflaps to comply to ADR42/04	
11		1	Certificate of Compliance & Owners manual	
12		1	GVM Upgrade Fitting Instructions	

SUSPENSION KITS

Kit Type	Part No.	Qty. per vehicle	Kit Description	Retail Price
GVM	FORDKIT018-GVM-PLAT	1	GVM Upgrade Kit (Fitted Price)	\$ 5,750.00
GVM	FORDKIT018-GVM-PLAT-EHD	1	GVM Upgrade Kit (Fitted Price) Heavy Duty Rear Springs	\$ 5,750.00

NOTE: Fitted Price plus GST

Optional parts

Item	Part No.	Qty. per vehicle	Accessory Description	List Price EACH
1A	LOVUCA-FR22	1	Lovells Extreme Upper Control Arm kit	\$ 995.00

Part No.	Load Rating	Description
All spring load ratings are an approximate only. Vehicle ride heights will vary depending on load and accessories fitted.		
FFS-92	0 to 100kg Constant Load	Suits Steel Bull Bar
FFR-92	100 to 150kg Constant Load	Suits Steel Bull Bar, Winch, Underbody Protection etc.
FRR-115HD	150 to 250kg Constant Load	To GVM
FRR-115EHD	250 to 300kg Constant Load	To GVM

FORD- Maverick (AUSTRALIA)

Wagon LWB

3/88-3/94

Coil/Coil

KIT COMPONENTS

Item	Part No.	Qty. per vehicle	Description	List Price EACH
1	DFS-41	2	Front Coil Springs- Standard Height (A)	\$ 126.26
2	DFR-41	2	Front Coil Springs- Raised (B)	\$ 126.26
3	DFR-41HD	2	Front Coil Springs- Raised Heavy Duty (C)	\$ 126.26
4	DRS-42	2	Rear Coil Springs- Standard Height (A)	\$ 194.64
5	DRR-42	2	Rear Coil Springs- Raised (B)	\$ 194.64
6	DRR-42HD	2	Rear Coil Springs- Raised Heavy Duty (C)	\$ 211.30
7	64612491	2	Front Gas Legend Shock Absorber	\$ 272.97
8	64612492-N	2	Rear Gas Legend Shock Absorber	\$ 244.03

SUSPENSION KITS

Kit Type	Part No.	Qty. per vehicle	Kit Description	List Price EACH
A	FORDKIT002-A	1	STANDARD HEIGHT	\$ 1,675.79
B	FORDKIT002-B	1	RAISED	\$ 1,675.79
C	FORDKIT002-C	1	RAISED HEAVY DUTY	\$ 1,709.11

ACCESSORIES (Not included in Kit)

Item	Part No.	Qty. per vehicle	Accessory Description	List Price EACH
1A	N81730	1	Front Urethane Bush Kit- Adjust. Caster Bush	\$ 297.55
2A	LPR004	1	Front Adjustable Panhard Rod Assembly	\$ 491.15
3A	N81429	1	Front Urethane Bush Kit- Rad. Arm to Chassis	\$ 84.08
4A	N21793	2	Front Urethane Bush Kit- Shock Absorber	\$ 44.42
5A	LPR005	1	Rear Adjustable Panhard Rod Assembly	\$ 491.15

STEERING DAMPERS (Not included in Kit)

Item	Part No.	Qty. per vehicle	Description	List Price EACH
1B	5450007	1	Steering Damper Assembly- Heavy Duty	\$ 161.74
Steering Damper P/N suits 3/88-8/89 build dates				
2B	5450008	1	Steering Damper Assembly- Heavy Duty	\$ 161.74
3B	5450008-RTC	1	Steering Damper Assembly- Return to Centre	\$ 202.68
Steering Damper P/N suits 8/89-3/94 build dates				

Highlighted Accessories: Lovells strongly recommend fitting these accessories when using Raised OR Raised Heavy Duty coil springs.

Part No.	Load Rating	Description
All spring load ratings are an approximate only. Vehicle ride heights will vary depending on load and accessories fitted.		
DFS-41	0 to 100kg Constant Load	Suits Steel Bull Bar
DFR-41	0 to 100kg Constant Load	Suits Steel Bull Bar
DFR-41HD	100 to 150kg Constant Load	Suits Steel Bull Bar, Winch, Underbody Protection etc.
DRS-42	0 to 100kg Constant Load	
DRR-42	0 to 100kg Constant Load	
DRR-42HD	150 to 250kg Constant Load	

FORD- Maverick (AUSTRALIA)
Wagon SWB
3/88-3/94
Coil/Coil



KIT COMPONENTS

Item	Part No.	Qty. per vehicle	Description	List Price EACH
1	DFS-31	2	Front Coil Springs- Standard Height (A)	\$ 118.00
2	DFR-31	2	Front Coil Springs- Raised (B)	\$ 126.26
3	DFS-41	2	Front Coil Springs- Raised Heavy Duty (C)	\$ 126.26
4	DRS-33	2	Rear Coil Springs- Standard Height (A)	\$ 141.02
5	DRR-33	2	Rear Coil Springs- Raised (B)	\$ 141.02
6	DRS-42	2	Rear Coil Springs- Raised Heavy Duty (C)	\$ 194.64
7	64612491	2	Front Gas Legend Shock Absorber	\$ 272.97
8	6462525N	2	Rear Gas Legend Shock Absorber	\$ 244.03

SUSPENSION KITS

Kit Type	Part No.	Qty. per vehicle	Kit Description	List Price EACH
A	FORDKIT003-A	1	STANDARD HEIGHT	\$ 1,552.03
B	FORDKIT003-B	1	RAISED	\$ 1,568.55
C	FORDKIT003-C	1	RAISED HEAVY DUTY	\$ 1,675.79

ACCESSORIES (Not included in Kit)

Item	Part No.	Qty. per vehicle	Accessory Description	List Price EACH
1A	N81730	1	Front Urethane Bush Kit- Adjust. Caster Bush	\$ 297.55
2A	LPR004	1	Front Adjustable Panhard Rod Assembly	\$ 494.15
3A	N81429	1	Front Urethane Bush Kit- Rad. Arm to Chassis	\$ 84.08
4A	N21793	2	Front Urethane Bush Kit- Shock Absorber	\$ 44.42
5A	LPR005	1	Rear Adjustable Panhard Rod Assembly	\$ 494.15
6A	646GQGBS	1	Gearbox Spacer Kit	\$ 200.00

STEERING DAMPERS (Not included in Kit)

Item	Part No.	Qty. per vehicle	Description	List Price EACH
1B	5450007	1	Steering Damper Assembly- Heavy Duty	\$ 161.74
Steering Damper P/N suits 3/88-8/89 build dates				
2B	5450008	1	Steering Damper Assembly- Heavy Duty	\$ 161.74
3B	5450008-RTC	1	Steering Damper Assembly- Return to Centre	\$ 202.68
Steering Damper P/N suits 8/89-3/94 build dates				

Highlighted Accessories: Lovells strongly recommend fitting these accessories when using Raised OR Raised Heavy Duty coil springs.

Note: If drive line vibration occurs use gearbox spacer kit 646GQGBS.

Part No.	Load Rating	Description
All spring load ratings are an approximate only. Vehicle ride heights will vary depending on load and accessories fitted.		
DFS-31	0 to 100kg Constant Load	Suits Steel Bull Bar
DFR-31	0 to 100kg Constant Load	Suits Steel Bull Bar
DFS-41	100 to 150kg Constant Load	Suits Steel Bull Bar, Winch, Underbody Protection etc.
DRS-33	0 to 100kg Constant Load	
DRR-33	0 to 100kg Constant Load	
DRS-42	150 to 200kg Constant Load	

FORD- Maverick (AUSTRALIA)

Tray Back

3/88-3/94

Leaf/Leaf

KIT COMPONENTS

Item	Part No.	Qty. per vehicle	Description	List Price EACH
1	NP-13	2	Front Leaf Springs- Raised (B)	\$ 515.73
2	NP-13HD	2	Front Leaf Springs- Raised Heavy Duty (C)	\$ 595.53
3	NP-12	2	Rear Leaf Springs- Raised (B)	\$ 1,319.12
4	NP-12HD	2	Rear Leaf Springs- Raised Heavy Duty (C)	\$ 1,435.57
5	N71708	1	Front Urethane Kit- Spring Front/Rear eyes/Shackle	\$ 179.45
6	N71042	1	Rear Urethane Kit- Spring Front/Rear eyes/Shackle	\$ 129.88
7	UBL-33	2	Front Driver Side U-Bolts	\$ 39.38
8	UBL-32	2	Front Passenger Side U-Bolts	\$ 24.61
9	UBL-15	4	Rear U-Bolts	\$ 24.61
10	LGSK666	2	Front Greasable Shackle Kit	\$ 58.80
11	LGPK667	2	Front Greasable Pin Kit	\$ 47.08
12	LGSK666	2	Rear Greasable Shackle Kit	\$ 58.80
13	LGPK667	2	Rear Greasable Pin Kit	\$ 47.08
14	6462526B	2	Front Gas Legend Shock Absorber	\$ 227.70
15	6462525P	2	Rear Gas Legend Shock Absorber	\$ 272.82

SUSPENSION KITS

Kit Type	Part No.	Qty. per vehicle	Kit Description	List Price EACH
B	FORDKIT004-B	1	RAISED	\$ 5,630.00
C	FORDKIT004-C	1	RAISED HEAVY DUTY	\$ 6,022.50

ACCESSORIES (Not included in Kit)

Item	Part No.	Qty. per vehicle	Accessory Description	List Price EACH
1A	N21172	1	Front Urethane Bush Kit- Shock Absorber Lower	\$ 31.65
2A	N21228	1	Rear Urethane Bush Kit- Sway Bar Mount	\$ 37.33
3A	N21793	1	Rear Urethane Bush Kit- Shock Absorber Upper	\$ 44.42
4A	N21172	1	Rear Urethane Bush Kit- Shock Absorber Lower	\$ 31.65

Note: Above spring Part Numbers suit alloy tray fitment only. For steel tray Part Numbers please contact Lovells Springs.

STEERING DAMPERS (Not included in Kit)

Item	Part No.	Qty. per vehicle	Description	List Price EACH
1B	5450009	1	Steering Damper Assembly- Heavy Duty	\$ 161.74
2B	5450009-RTC	1	Steering Damper Assembly- Return to Centre	\$ 202.68

Part No.	Load Rating	Description
All spring load ratings are an approximate only. Vehicle ride heights will vary depending on load and accessories fitted.		
NP-13	0 to 100kg Constant Load	Suits Steel Bull Bar
NP-13HD	150 to 250kg Constant Load	Suits Steel Bull Bar, Winch, Underbody Protection etc.
NP-12	0 to 100kg Constant Load	
NP-12HD	150 to 250kg Constant Load	

FORD- Maverick (AUSTRALIA)

Tray Back

1991-3/94

Coil/Coil

KIT COMPONENTS

Item	Part No.	Qty. per vehicle	Description	List Price EACH
1	DFR-41	2	Front Coil Springs- Raised (B)	\$ 118.00
2	DFR-41HD	2	Front Coil Springs- Raised Heavy Duty (C)	\$ 118.00
3	DRR-49	2	Rear Coil Springs- Raised (B)	\$ 135.00
4	DRR-49HD	2	Rear Coil Springs- Raised Heavy Duty (C)	\$ 135.00
5	64612491	2	Front Gas Legend Shock Absorber	\$ 272.97
6	64612492	2	Rear Gas Legend Shock Absorber	\$ 270.69

SUSPENSION KITS

Kit Type	Part No.	Qty. per vehicle	Kit Description	List Price EACH
B	FORDKIT005-B	1	RAISED	\$ 1,593.32
C	FORDKIT005-C	1	RAISED HEAVY DUTY	\$ 1,593.32

ACCESSORIES (Not included in Kit)

Item	Part No.	Qty. per vehicle	Accessory Description	List Price EACH
1A	N81730	1	Front Urethane Bush Kit- Adjust. Caster Bush	\$ 297.55
2A	LPR004	1	Front Adjustable Panhard Rod Assembly	\$ 494.15
3A	N81429	1	Front Urethane Bush Kit- Rad. Arm to Chassis	\$ 84.08
4A	N21793	2	Front Urethane Bush Kit- Shock Absorber	\$ 44.42
5A	LPR005	1	Rear Adjustable Panhard Rod Assembly	\$ 494.15

Note: Above spring Part Numbers suit alloy tray fitment only. For steel tray Part Numbers please contact Lovells Springs.

STEERING DAMPERS (Not included in Kit)

Item	Part No.	Qty. per vehicle	Description	List Price EACH
3B	5450008	1	Steering Damper Assembly- Heavy Duty	\$ 161.74
4B	5450008-RTC	1	Steering Damper Assembly- Return to Centre	\$ 202.68

Highlighted Accessories: Lovells strongly recommend fitting these accessories when using Raised OR Raised Heavy Duty springs.

Part No.	Load Rating	Description
All spring load ratings are an approximate only. Vehicle ride heights will vary depending on load and accessories fitted.		
DFR-41	0 to 100kg Constant Load	Suits Steel Bull Bar
DFR-41HD	150 to 150kg Constant Load	Suits Steel Bull Bar, Winch, Underbody Protection etc.
DRR-49	0 to 100kg Constant Load	
DRR-49HD	150 to 250kg Constant Load	

FORD- Raider
UV Wagon
8/91-96
Torsion Bar/Leaf



KIT COMPONENTS

Item	Part No.	Qty. per vehicle	Description	List Price EACH
1	MAZDA005	1 Pair	Front Heavy Duty Torsion Bars	\$ 530.35
2	MR-26	2	Rear Leaf Springs- Raised (B)	\$ 615.05
3	MR-26HD	2	Rear Leaf Springs- Raised Heavy Duty (C)	\$ 644.33
4	N72065	1	Rear Urethane Bush Kit- Spring Front eye	\$ 88.74
5	N71136	1	Rear Urethane Bush Kit- Spring Rear eye	\$ 47.33
6	N71215	1	Rear Urethane Bush Kit- Spring Shackle	\$ 60.24
7	UBL-18	4	Rear U-Bolts	\$ 24.61
8	LGSKMAZ-001	2	Rear Greasable Shackle	\$ 53.93
9	LGPKFD-004	2	Rear Greasable Pin	\$ 66.88
10	6462543P	2	Front Gas Legend Shock Absorber	\$ 244.03
11	6462525T	2	Rear Gas Legend Shock Absorber	\$ 268.60

SUSPENSION KITS

Kit Type	Part No.	Qty. per vehicle	Kit Description	List Price EACH
B	FORDKIT006-B	1	RAISED	\$ 3,322.07
C	FORDKIT006-C	1	RAISED HEAVY DUTY	\$ 3,380.63

ACCESSORIES (Not included in Kit)

Item	Part No.	Qty. per vehicle	Accessory Description	List Price EACH
1A	N11421	1	Front Urethane Bush Kit- Steering Idler Bush	\$ 35.89
2A	N31207	1	Front Urethane Bush Kit- Sway Bar Link	\$ 52.86
3A	N21058	1	Front Urethane Bush Kit- Sway Bar Mount	\$ 30.34
4A	N21172	1	Front Urethane Bush Kit- Shock Absorber Upper	\$ 31.65

Part No.	Load Rating	Description
All spring load ratings are an approximate only. Vehicle ride heights will vary depending on load and accessories fitted.		
MR-26	0 to 100kg Constant Load	
MR-26HD	100 to 250kg Constant Load	



FORD- Ranger
PJ Super Cab Pick Up and Tray Back
12/06-12/11
Torsion Bar/Leaf

KIT COMPONENTS

Item	Part No.	Qty. per vehicle	Description	List Price EACH
1	MAZDA003	1 Pair	Front Heavy Duty Torsion Bars	\$ 660.33
2	MR-28	2	Rear Leaf Springs- Raised (B)	\$ 652.27
3	MR-28HD	2	Rear Leaf Springs- Raised Heavy Duty (C)	\$ 794.39
4	MR-28EHD	2	Rear Leaf Springs- Raised Extra Heavy Duty	\$ 861.30
5	N73383	1	Rear Urethane Bush Kit- Spring Front eye	\$ 63.53
6	N71136	1	Rear Urethane Bush Kit- Spring Rear eye	\$ 47.33
7	N71215	1	Rear Urethane Bush Kit- Shackle	\$ 60.24
8	UBL-50	4	Rear U-Bolts	\$ 24.61
9	LGSKMAZ-001	2	Rear Greasable Shackle Kit	\$ 53.93
10	LGPK387-2	2	Rear Greasable Pin Kit	\$ 47.08
11	6462543P	2	Front Gas Legend Shock Absorber	\$ 244.03
12	6462525T	2	Rear Gas Legend Shock Absorber	\$ 268.60

SUSPENSION KITS

Kit Type	Part No.	Qty. per vehicle	Kit Description	List Price EACH
B	FORDKIT007-B	1	RAISED	\$ 3,461.68
C	FORDKIT007-C	1	RAISED HEAVY DUTY	\$ 3,745.92

ACCESSORIES (Not included in Kit)

Item	Part No.	Qty. per vehicle	Accessory Description	List Price EACH
1A	N11421	1	Front Urethane Bush Kit- Steering Idler Bush	\$ 35.89
2A	N31207	1	Front Urethane Bush Kit- Sway Bar Link	\$ 52.86
3A	N21058	1	Front Urethane Bush Kit- Sway Bar Mount	\$ 30.34
4A	N21172	1	Front Urethane Bush Kit- Shock Absorber Upper	\$ 31.65

Part No.	Load Rating	Description
All spring load ratings are an approximate only. Vehicle ride heights will vary depending on load and accessories fitted.		
MR-28	0 to 100kg Constant Load	
MR-28HD	100 to 250kg Constant Load	
MR-28EHD	250 to 300kg Constant Load	

FORD- Ranger
PXI & PXII Pick Up and Tray Back
01/12-05/18
Coil/Leaf

KIT COMPONENTS

Item	Part No.	Qty. per vehicle	Description	List Price EACH
1	FFS-90	2	Front Coil Springs- Standard Height (A)	\$ 126.26
2	FFR-90	2	Front Coil Springs- Raised (B)	\$ 126.26
3	FFR-90HD	2	Front Coil Springs- Raised Heavy Duty (C&D)	\$ 126.26
4	FR-1SH	2	Rear Leaf Springs- Standard (A)	\$ 616.26
5	FR-1	2	Rear Leaf Springs- Raised (B)	\$ 616.29
6	FR-1HD	2	Rear Leaf Springs- Raised Heavy Duty (C)	\$ 795.39
7	FR-1XHD	2	Rear Leaf Springs- Raised Heavy Duty (D)	\$ 937.13
8	N73395	1	Rear Urethane Bush Kit- Spring Rear eyes	\$ 43.44
9	N73396	1	Rear Urethane Bush Kit- Shackle Bush Kit	\$ 51.60
10	N73394	1	Rear Urethane Bush Kit- Spring Front eyes	\$ 114.52
11	UBL-39	4	Rear U-Bolts	\$ 24.61
12	LGSK390	2	Rear Greasable Shackle Kit	\$ 96.30
13	LGPK387-2	2	Rear Greasable Pin Kit	\$ 47.08
14	64611037	2	Front Gas Legend Strut	\$ 331.67
15	6462525T	2	Rear Gas Legend Shock Absorber	\$ 268.60

SUSPENSION KITS

Kit Type	Part No.	Qty. per vehicle	Kit Description	List Price EACH
A	FORDKIT008-A	1	STANDARD	\$ 3,280.35
B	FORDKIT008-B	1	RAISED	\$ 3,280.40
C	FORDKIT008-C	1	RAISED HEAVY DUTY	\$ 3,638.60
D	FORDKIT008-D	1	RAISED EXTRA HEAVY DUTY	\$ 3,922.08

Optional parts

Item	Part No.	Qty. per vehicle	Option Description	List Price EACH
1A	LPWR56509	1	Lovells Radiator Closemesh (PXII Only)	\$ 2,363.78
2A	LPWI53860	1	Lovells Intercooler (PXII Only)	\$ 1,932.30
3A	LOVUCA-GEN2	1	Lovells Extreme Upper Control Arm kit	\$ 920.00

ACCESSORIES (Not included in Kit)

Item	Part No.	Qty. per vehicle	Accessory Description	List Price EACH
1A	TSTMAZ-001	1	Drive Shaft Spacer Kit	\$ 94.15

Highlighted Accessories: Lovells strongly recommend fitting these accessories when using Raised OR Raised Heavy Duty springs.

Note: When fitting raised rear springs to this vehicle, driveline vibration can occur. Lovells recommend using the above drive shaft spacer kit.

Part No.	Load Rating	Description
All spring load ratings are an approximate only. Vehicle ride heights will vary depending on load and accessories fitted.		
FFS-90	0 to 100kg Constant Load	Suits Steel Bull Bar
FFR-90	0 to 100kg Constant Load	Suits Steel Bull Bar
FFR-90HD	100 to 150kg Constant Load	Suits Steel Bull Bar, Winch, Underbody Protection etc.
FR-1SH	0 to 100kg Constant Load	
FR-1	0 to 100kg Constant Load	
FR-1HD	150 to 250kg Constant Load	
FR-1XHD	400-500kg constant load	

FORD- Ranger
PXI & PXII Pick Up and Tray Back
01/12-05/18
Coil/Leaf

3500KG GVM Upgrade Kit (Fitted Price)-State Compliance

KIT COMPONENTS

Item	Part No.	Qty. per vehicle	Description	SOLD AS KIT ONLY
1	FFS-90	2	Front Coil Springs	
2	FR-1XHD	2	Rear Leaf Springs	
3	N73395	1	Rear Urethane Bush Kit- Spring Rear eyes	
4	N73396	1	Rear Urethane Bush Kit- Shackle Bush Kit	
5	N73394	1	Rear Urethane Bush Kit- Spring Front eyes	
6	UBL-39	4	Rear U-Bolts	
7	LGSK390	2	Rear Greasable Shackle Kit	
8	LGPK387-2	2	Rear Greasable Pin Kit	
9	64611037	2	Front Gas Legend Strut	
10	6462525T	2	Rear Gas Legend Shock Absorber	
11		1	3500kg Compliance Plate	
12		1	Re-Tension U-Bolts Warning (Decal)	
13		1	3500kg Tyre Loading Placard (Decal)	
14		2	Lovells Mudflaps	
15		1	Owners Manual	
16		1	GVM Upgrade Fitting Instructions	

SUSPENSION KITS

Kit Type	Part No.	Qty. per vehicle	Kit Description	Retail Price
GVM	FORDKIT009-GVM	1	GVM Upgrade Kit (Fitted Price)	\$ 5,400.00

NOTE: Fitted Price plus GST

Optional parts

Item	Part No.	Qty. per vehicle	Option Description	List Price EACH
1A	LPWR56509	1	Lovells Radiator Closemesh (PXII Only)	\$ 2,363.78
2A	LPWI53860	1	Lovells Intercooler (PXII Only)	\$ 1,932.30
3A	LOVUCA-GEN2	1	Lovells Extreme Upper Control Arm kit	\$ 920.00

ACCESSORIES (Not included in Kit)

Item	Part No.	Qty. per vehicle	Accessory Description	List Price EACH
1A	TSTMAZ-001	1	Drive Shaft Spacer Kit	\$ 94.15

Part No.	Load Rating	Description
All spring load ratings are an approximate only. Vehicle ride heights will vary depending on load and accessories fitted.		
FFS-90	0 to 100kg Constant Load	Suits Steel Bull Bar
FR-1XHD	400-500kg constant load	To GVM

*****NOTE:** The above GVM Upgrade Kit for Federal Compliance under Second Stage Manufacturer Approval, with a Federal compliance plate, is no longer available
 The above kit can still be supplied under State Compliance and will require inspection, by a Lovells endorsed signatory and /or Production Facility.
 Consult your nearest Lovells Production facility for Individual State requirements.

FORD- Ranger
2WD PXII (4x2) Pick Up and Tray Back
08/15 on
Coil/Leaf

3500KG GVM Upgrade Kit (Fitted Price)-State Compliance

KIT COMPONENTS

Item	Part No.	Qty. per vehicle	Description	SOLD AS KIT ONLY
1	FFS-90	2	Front Coil Springs	
2	FR-1XHD	2	Rear Leaf Springs	
3	N73395	1	Rear Urethane Bush Kit- Spring Rear eyes	
4	N73396	1	Rear Urethane Bush Kit- Shackle Bush Kit	
5	N73394	1	Rear Urethane Bush Kit- Spring Front eyes	
6	UBL-39	4	Rear U-Bolts	
7	LGSK390	2	Rear Greasable Shackle Kit	
8	LGPK387-2	2	Rear Greasable Pin Kit	
9	64611037	2	Front Gas Legend Strut	
10	6462525T	2	Rear Gas Legend Shock Absorber	
11		1	3500kg Compliance Plate	
12		1	Re-Tension U-Bolts Warning (Decal)	
13		1	3500kg Tyre Loading Placard (Decal)	
14		2	Lovells Mudflaps	
15		1	Owners Manual	
16		1	GVM Upgrade Fitting Instructions	

SUSPENSION KITS

Kit Type	Part No.	Qty. per vehicle	Kit Description	Retail Price
GVM	FORDKIT010-GVM	1	GVM Upgrade Kit (Fitted Price)	\$ 5,200.00

NOTE: Fitted Price plus GST

Part No.	Load Rating	Description
All spring load ratings are an approximate only. Vehicle ride heights will vary depending on load and accessories fitted.		
FFS-90	0 to 100kg Constant Load	Suits Steel Bull Bar
FR-1XHD	400-500kg constant load	To GVM

***NOTE: The above GVM Upgrade Kit for Federal Compliance under Second Stage Manufacturer Approval, with a Federal compliance plate, is no longer available
 The above kit can still be supplied under State Compliance and will require inspection, by a Lovells endorsed signatory and /or Production Facility.
 Consult your nearest Lovells Production facility for Individual State requirements.

FORD- Ranger
PXIII Pick Up and Tray Back
06/18 on
Coil/Leaf

KIT COMPONENTS

Item	Part No.	Qty. per vehicle	Description	List Price EACH
1	FFS-91	2	Front Coil Springs- Standard Height (A)	\$ 126.26
2	FFR-91	2	Front Coil Springs- Raised (B)	\$ 126.26
3	FFR-91HD	2	Front Coil Springs- Raised Heavy Duty (C&D)	\$ 126.26
4	FR-1SH	2	Rear Leaf Springs- Standard (A)	\$ 616.26
5	FR-1	2	Rear Leaf Springs- Raised (B)	\$ 616.29
6	FR-1HD	2	Rear Leaf Springs- Raised Heavy Duty (C)	\$ 795.39
7	FR-1XHD	2	Rear Leaf Springs- Raised Extra Heavy Duty (D)	\$ 937.13
8	N73395	1	Rear Urethane Bush Kit- Spring Rear eyes	\$ 43.44
9	N73396	1	Rear Urethane Bush Kit- Shackle Bush Kit	\$ 51.60
10	N73394	1	Rear Urethane Bush Kit- Spring Front eyes	\$ 114.52
11	UBL-39	4	Rear U-Bolts	\$ 24.61
12	LGSK390	2	Rear Greasable Shackle Kit	\$ 96.30
13	LGPK387-2	2	Rear Greasable Pin Kit	\$ 47.08
14	64611049	2	Front Gas Legend Strut	\$ 335.22
15	6462525T	2	Rear Gas Legend Shock Absorber	\$ 268.60

SUSPENSION KITS

Kit Type	Part No.	Qty. per vehicle	Kit Description	List Price EACH
A	FORDKIT011-A	1	STANDARD	\$ 3,287.45
B	FORDKIT011-B	1	RAISED	\$ 3,287.50
C	FORDKIT011-C	1	RAISED HEAVY DUTY	\$ 3,645.69
D	FORDKIT011-D	1	RAISED EXTRA HEAVY DUTY	\$ 3,929.18

Optional parts

Item	Part No.	Qty. per vehicle	Option Description	List Price EACH
1A	LPWR56509	1	Lovells Radiator Closemesh (Excludes 2.0 Litre Bi-Turbo)	\$ 2,363.78
2A	LPWI53860	1	Lovells Intercooler (Excludes 2.0 Litre Bi-Turbo)	\$ 1,932.30
3A	LOVUCA-GEN2	1	Lovells Extreme Upper Control Arm kit	\$ 920.00

ACCESSORIES (Not included in Kit)

Item	Part No.	Qty. per vehicle	Accessory Description	List Price EACH
1A	TSTMAZ-001	1	Drive Shaft Spacer Kit	\$ 94.15

Note: When fitting raised rear springs to this vehicle, driveline vibration can occur.
 Lovells recommend using the above drive shaft spacer kit.

Part No.	Load Rating	Description
All spring load ratings are an approximate only. Vehicle ride heights will vary depending on load and accessories fitted.		
FFS-91	0 to 100kg Constant Load	Suits Steel Bull Bar
FFR-91	0 to 100kg Constant Load	Suits Steel Bull Bar
FFR-91HD	100 to 150kg Constant Load	Suits Steel Bull Bar, Winch, Underbody Protection etc.
FR-1SH	0 to 100kg Constant Load	
FR-1	0 to 100kg Constant Load	
FR-1HD	150 to 250kg Constant Load	
FR-1XHD	400-500kg constant load	

FORD- Ranger
PXIII Pick Up and Tray Back
06/18 on
Coil/Leaf

3500KG GVM Upgrade Kit (Fitted Price)-State Compliance

KIT COMPONENTS

Item	Part No.	Qty. per vehicle	Description	SOLD AS KIT ONLY
1	FFS-91	2	Front Coil Springs	
2	FR-1XHD	2	Rear Leaf Springs	
3	N73395	1	Rear Urethane Bush Kit- Spring Rear eyes	
4	N73396	1	Rear Urethane Bush Kit- Shackle Bush Kit	
5	N73394	1	Rear Urethane Bush Kit- Spring Front eyes	
6	UBL-39	4	Rear U-Bolts	
7	LGSK390	2	Rear Greasable Shackle Kit	
8	LGPK387-2	2	Rear Greasable Pin Kit	
9	64611049	2	Front Gas Legend Strut	
10	6462525T	2	Rear Gas Legend Shock Absorber	
11		1	3500kg Compliance Plate	
12		1	Re-Tension U-Bolts Warning (Decal)	
13		1	3500kg Tyre Loading Placard (Decal)	
14		2	Lovells Mudflaps	
15		1	Owners Manual	
16		1	GVM Upgrade Fitting Instructions	

SUSPENSION KITS

Kit Type	Part No.	Qty. per vehicle	Kit Description	Retail Price
GVM	FORDKIT012-GVM	1	GVM Upgrade Kit (Fitted Price)	\$ 5,400.00

NOTE: Fitted Price plus GST

Optional parts

Item	Part No.	Qty. per vehicle	Option Description	List Price EACH
1A	LPWR56509	1	Lovells Radiator Closemesh (Excludes 2.0 Litre Bi-Turbo)	\$ 2,363.78
2A	LPWI53860	1	Lovells Intercooler (Excludes 2.0 Litre Bi-Turbo)	\$ 1,932.30
3A	LOVUCA-GEN2	1	Lovells Extreme Upper Control Arm kit	\$ 920.00

ACCESSORIES (Not included in Kit)

Item	Part No.	Qty. per vehicle	Accessory Description	List Price EACH
1A	TSTMAZ-001	1	Drive Shaft Spacer Kit	\$ 94.15

Part No.	Load Rating	Description
All spring load ratings are an approximate only. Vehicle ride heights will vary depending on load and accessories fitted.		
FFS-91	0 to 100kg Constant Load	Suits Steel Bull Bar
FR-1XHD	400-500kg constant load	To GVM

*****NOTE:** The above GVM Upgrade Kit for Federal Compliance under Second Stage Manufacturer Approval, with a Federal compliance plate, is no longer available
 The above kit can still be supplied under State Compliance and will require inspection, by a Lovells endorsed signatory and /or Production Facility.
 Consult your nearest Lovells Production facility for Individual State requirements.

FORD- Ranger
Gen 3 PY Pick Up and Tray Back
03/22 on
Coil/Leaf

KIT COMPONENTS

Item	Part No.	Qty. per vehicle	Description	List Price EACH
1	FFS-92	2	Front Coil Springs- Standard Height (A)	\$ 118.00
2	FFR-92	2	Front Coil Springs- Raised (B and C)	\$ 118.00
6	FR-2HD	2	Rear Leaf Springs- Raised Heavy Duty (A and B)	\$ 790.37
7	FR-2XHD	2	Rear Leaf Springs- Raised Extra Heavy Duty (C)	\$ 875.82
8	N73395	1	Rear Urethane Bush Kit- Spring Rear eyes	\$ 43.44
9	N73396	1	Rear Urethane Bush Kit- Shackle Bush Kit	\$ 51.60
10	N73394	1	Rear Urethane Bush Kit- Spring Front eyes	\$ 114.52
11	UBL-40	4	Rear U-Bolts	\$ 66.44
12	LGSK390	2	Rear Greasable Shackle Kit	\$ 96.30
13	LGPK387-2	2	Rear Greasable Pin Kit	\$ 47.08
14	64612857	2	Front Gas Legend Strut	\$ 335.22
15	64612858	2	Rear Gas Legend Shock Absorber	\$ 244.02
16	TSFORD-001	1	Drive Shaft Spacer Kit	\$ 49.60
17	LOV-WEDGE	2	Rear Spring Wedge	\$ 148.02

SUSPENSION KITS

Kit Type	Part No.	Qty. per vehicle	Kit Description	List Price EACH
A	FORDKIT019-A	1	STANDARD	\$ 4,082.93
B	FORDKIT019-B	1	RAISED	\$ 4,082.93
C	FORDKIT019-C	1	RAISED HEAVY DUTY	\$ 4,253.83

Optional parts

Item	Part No.	Qty. per vehicle	Accessory Description	List Price EACH
1A	LOVUCA-FR22	1	Lovells Extreme Upper Control Arm kit	\$ 995.00
2A	1121-160001	1	Headlight Adj Spacer (Mounts on rear spring) Wildtrac and Platinum Models	\$ 31.00

Part No.	Load Rating	Description
All spring load ratings are an approximate only. Vehicle ride heights will vary depending on load and accessories fitted.		
FFS-92	0 to 100kg Constant Load	Suits Steel Bull Bar
FFR-92	0 to 100kg Constant Load	Suits Steel Bull Bar, Winch, Underbody Protection etc.
FR-2HD	150 to 250kg Constant Load	
FR-2XHD	400-500kg constant load	

FORD- Ranger
Gen 3 PY Pick Up and Tray Back
03/22 on
Coil/Leaf

GVM Upgrade Kit (Fitted Price)-Federal Compliance
3505kg

KIT COMPONENTS

Item	Part No.	Qty. per vehicle	Description	SOLD AS KIT ONLY
1	FFS-92	2	Front Coil Springs	
Vehicles with minimal or no load bearing front accessories. Axle Capacities under 1400kg				
OR				
2	FFR-92	2	Front Coil Springs	
Vehicles with load bearing accessories, i.e Steel Bull Bar, winch, Dual batteries				
3	FR-2HD	2	Rear Leaf Springs- Raised Heavy Duty	
Vehicles with load bearing rear accessories. Axle Capacities over 1200kg				
4	64612857	2	Front Gas Legend Strut	
5	64612858	2	Rear Gas Legend Shock Absorber	
6	N73395	1	Rear Urethane Bush Kit- Spring Rear eyes	
7	N73396	1	Rear Urethane Bush Kit- Shackle Bush Kit	
8	N73394	1	Rear Urethane Bush Kit- Spring Front eyes	
9	UBL-40	4	Rear U-Bolts	
10	LGSK390	2	Rear Greasable Shackle Kit	
11	LGPK387-2	2	Rear Greasable Pin Kit	
12	TSFORD-001	1	Drive Shaft Spacer Kit	
13	LOV-WEDGE	2	Rear Spring Wedge	
14	77ACMB-RANGER22	2	Cat 6 Indicators	
15		1	3505kg Tyre Loading Placard (Decal)	
16		1	GVM Upgrade Fitting Instructions	
17		1	Owners Manual	
18		1	3505kg Compliance plate	
19		1	U-Bolt Retension Warning Decal	

Optional parts

Item	Part No.	Qty. per vehicle	Option Description	List Price EACH
1A	LOVUCA-FR22	1	Lovells Extreme Upper Control Arm kit	\$ 995.00
2A	1121-160001	1	Headlight Adj Spacer (Mounts on rear spring) Wildtrac and Platinum Models	\$ 31.00

SUSPENSION KITS

Kit Type	Part No.	Qty. per vehicle	Kit Description	Retail Price
GVM	FORDKIT019-GVM-CMFT	1	COMFORT SERIES GVM Kit (Fitted Price)	\$ 4,800.00

NOTE: Fitted Price plus GST

Part No.	Load Rating	Description
All spring load ratings are an approximate only. Vehicle ride heights will vary depending on load and accessories fitted.		
FFS-92	0 to 100kg Constant Load	Suits Steel Bull Bar
FFR-92	0 to 100kg Constant Load	Suits Steel Bull Bar, Winch, Underbody Protection etc.
FR-2HD	150 to 250kg Constant Load	To GVM

FORD- Ranger
Gen 3 PY Pick Up and Tray Back
03/22 on
Coil/Leaf

GVM Upgrade Kit (Fitted Price)-Federal Compliance
3700kg

KIT COMPONENTS

Item	Part No.	Qty. per vehicle	Description	SOLD AS KIT ONLY
1	FFS-92	2	Front Coil Springs	
Vehicles with minimal or no load bearing front accessories. Axle Capacities under 1400kg				
OR				
2	FFR-92	2	Front Coil Springs	
Vehicles with load bearing accessories, i.e Steel Bull Bar, winch, Dual batteries				
3	FR-2XHD	2	Rear Leaf Springs- Raised Heavy Duty	
Vehicles with load bearing rear accessories. Axle Capacities over 1460kg				
4	64612857	2	Front Gas Legend Strut	
5	64612858	2	Rear Gas Legend Shock Absorber	
6	N73395	1	Rear Urethane Bush Kit- Spring Rear eyes	
7	N73396	1	Rear Urethane Bush Kit- Shackle Bush Kit	
8	N73394	1	Rear Urethane Bush Kit- Spring Front eyes	
9	UBL-40	4	Rear U-Bolts	
10	LGSK390	2	Rear Greasable Shackle Kit	
11	LGPK387-2	2	Rear Greasable Pin Kit	
12	TSFORD-001	1	Drive Shaft Spacer Kit	
13	LOV-WEDGE	2	Rear Spring Wedge	
14	77ACMB-RANGER22	2	Cat 6 Indicators	
15		1	3700kg Tyre Loading Placard (Decal)	
16		1	GVM Upgrade Fitting Instructions	
17		1	Owners Manual	
18		1	3700kg Compliance plate	
19		1	U-Bolt Retension Warning Decal	

Optional parts

Item	Part No.	Qty. per vehicle	Option Description	List Price EACH
1A	LOVUCA-FR22	1	Lovells Extreme Upper Control Arm kit	\$ 995.00
2A	1121-160001	1	Headlight Adj Spacer (Mounts on rear spring) Wildtrac and Platinum Models	\$ 31.00

SUSPENSION KITS

Kit Type	Part No.	Qty. per vehicle	Kit Description	Retail Price
GVM	FORDKIT019-GVM	1	GVM Kit (Fitted Price)	\$ 5,400.00

NOTE: Fitted Price plus GST

Part No.	Load Rating	Description
All spring load ratings are an approximate only. Vehicle ride heights will vary depending on load and accessories fitted.		
FFS-92	0 to 100kg Constant Load	Suits Steel Bull Bar
FFR-92	0 to 100kg Constant Load	Suits Steel Bull Bar, Winch, Underbody Protection etc.
FR-2XHD	400-500kg constant load	To GVM

HOLDEN- Colorado
RC Pick Up
8/08-5/12
Torsion Bar/Leaf

KIT COMPONENTS

Item	Part No.	Qty. per vehicle	Description	List Price EACH
1	HOLD010	1 Pair	Front Heavy Duty Torsion Bars	\$ 660.33
2	HR-18SH	2	Rear Leaf Springs- Standard (A)	\$ 661.59
3	HR-18	2	Rear Leaf Springs- Raised (B)	\$ 690.99
4	HR-18HD	2	Rear Leaf Springs- Raised Heavy Duty (C)	\$ 766.34
5	N71506	1	Rear Urethane Bush Kit- Spring Front eye	\$ 79.05
6	N71021	2	Rear Urethane Bush Kit- Spring Rear eye/shackle	\$ 42.23
7	UBL-50	4	Rear U-Bolts	\$ 24.61
8	LGSK386	2	Rear Greasable Shackle	\$ 53.93
9	LGPK387-2	2	Rear Greasable Pin	\$ 47.08
10	64612545	2	Front Gas Legend Shock Absorber	\$ 244.03
11	6462258B	2	Rear Gas Legend Shock Absorber	\$ 269.38

SUSPENSION KITS

Kit Type	Part No.	Qty. per vehicle	Kit Description	List Price EACH
A	HOLDKIT011-A	1	STANDARD HEIGHT	\$ 3,474.29
B	HOLDKIT011-B	1	RAISED	\$ 3,533.09
C	HOLDKIT011-C	1	RAISED HEAVY DUTY	\$ 3,683.79

ACCESSORIES (Not included in Kit)

Item	Part No.	Qty. per vehicle	Accessory Description	List Price EACH
1A	N21172	1	Front Urethane Bush Kit- Shock Absorber Upper	\$ 31.65

Part No.	Load Rating	Description
All spring load ratings are an approximate only. Vehicle ride heights will vary depending on load and accessories fitted.		
HR-18SH	0 to 100kg Constant Load	
HR-18	0 to 100kg Constant Load	
HR-18HD	150 to 250kg Constant Load	

HOLDEN- Colorado
RG Pick Up
6/12-3/13
Coil/Leaf

KIT COMPONENTS

Item	Part No.	Qty. per vehicle	Description	List Price EACH
1	TFS-118	2	Front Coil Springs- Raised (B)	\$ 126.26
2	TFR-118	2	Front Coil Springs- Raised Heavy Duty (C)	\$ 126.26
3	IS-003	2	Rear Leaf Springs- Raised (B)	\$ 639.99
4	IS-003HD	2	Rear Leaf Springs- Raised Heavy Duty (C)	\$ 799.99
5	N73254	1	Rear Urethane Bush Kit- Spring Front eyes	\$ 83.71
6	N73255	1	Rear Urethane Bush Kit- Spring Front eyes/shackle	\$ 110.28
7	UBL-05	4	Rear U-Bolts	\$ 24.61
8	LGSK386/3	2	Rear Greasable Shackle Kit	\$ 53.93
9	LGPK387-2	2	Rear Pin Kit (Non Greasable)	\$ 47.08
10	64611038	2	Front Gas Legend Strut	\$ 329.07
11	6462258B	2	Rear Gas Legend Shock Absorber	\$ 269.38
12	64611038LH-2.0ADJMONO	1	Front 2.0" Mono Tube Strut with Remote Reservoir (Platinum)	\$ 720.65
13	64611038RH-2.0ADJMONO	1	Front 2.0" Mono Tube Strut with Remote Reservoir (Platinum)	\$ 720.65
14	6462258B-2.0ADJMONO	2	Front 2.0" Mono Tube Strut with Remote Reservoir (Platinum)	\$ 678.59

SUSPENSION KITS

Kit Type	Part No.	Qty. per vehicle	Kit Description	List Price EACH
B	HOLDKIT012-B	1	RAISED	\$ 3,223.86
C	HOLDKIT012-C	1	RAISED HEAVY DUTY	\$ 3,543.85
B Platinum	HOLDKIT012-B-PLAT	1	RAISED	\$ 4,825.42
C Platinum	HOLDKIT012-C-PLAT	1	RAISED HEAVY DUTY	\$ 5,145.42

NOTE: Lovells front coil springs will not fit struts with a rolled lower spring seat. For correct fitment always use with a Lovells strut.

Part No.	Load Rating	Description
All spring load ratings are an approximate only. Vehicle ride heights will vary depending on load and accessories fitted.		
TFS-118	0 to 100kg Constant Load	Suits Steel Bull Bar
TFR-118	0 to 100kg Constant Load	Suits Steel Bull Bar
IS-003	0 to 100kg Constant Load	
IS-003HD	150 to 250kg Constant Load	

HOLDEN- Colorado
RG Pick Up
4/13 on
Coil/Leaf

KIT COMPONENTS

Item	Part No.	Qty. per vehicle	Description	List Price EACH
1	TFS-118-B	2	Front Coil Springs- Raised (B)	\$ 118.00
2	TFR-118-B	2	Front Coil Springs- Raised Heavy Duty (C)	\$ 118.00
3	IS-003	2	Rear Leaf Springs- Raised (B)	\$ 639.99
4	IS-003HD	2	Rear Leaf Springs- Raised Heavy Duty (C)	\$ 799.99
5	N73254	1	Rear Urethane Bush Kit- Spring Front eyes	\$ 83.71
6	N73255	1	Rear Urethane Bush Kit- Spring Front eyes/shackle	\$ 110.28
7	UBL-05	4	Rear U-Bolts	\$ 24.61
8	LGSK386/3	2	Rear Greasable Shackle Kit	\$ 53.93
9	LGPK387-2	2	Rear Pin Kit (Non Greasable)	\$ 47.08
10	64611038	2	Front Gas Legend Strut	\$ 329.07
11	6462258B	2	Rear Gas Legend Shock Absorber	\$ 269.38
12	64611038LH-2.0ADJMONO	1	Front 2.0" Mono Tube Strut with Remote Reservoir (Platinum)	\$ 720.65
13	64611038RH-2.0ADJMONO	1	Front 2.0" Mono Tube Strut with Remote Reservoir (Platinum)	\$ 720.65
14	6462258B-2.0ADJMONO	2	Front 2.0" Mono Tube Strut with Remote Reservoir (Platinum)	\$ 678.59

SUSPENSION KITS

Kit Type	Part No.	Qty. per vehicle	Kit Description	List Price EACH
B	HOLDKIT013-B	1	RAISED	\$ 3,207.34
C	HOLDKIT013-C	1	RAISED HEAVY DUTY	\$ 3,527.33
B Platinum	HOLDKIT013-B-PLAT	1	RAISED	\$ 4,808.90
C Platinum	HOLDKIT013-C-PLAT	1	RAISED HEAVY DUTY	\$ 5,128.90

NOTE: Lovells front coil springs will not fit struts with a rolled lower spring seat. For correct fitment always use with a Lovells strut.

Part No.	Load Rating	Description
All spring load ratings are an approximate only. Vehicle ride heights will vary depending on load and accessories fitted.		
TFS-118-B	0 to 100kg Constant Load	Suits Steel Bull Bar
TFR-118-B	0 to 100kg Constant Load	Suits Steel Bull Bar
IS-003	0 to 100kg Constant Load	
IS-003HD	150 to 250kg Constant Load	

HOLDEN- Jackaroo (Isuzu Trooper- EXPORT)
UBS 13,16,52 Wagon SWB
11/81-86
Torsion Bar/Leaf



KIT COMPONENTS

Item	Part No.	Qty. per vehicle	Description	List Price EACH
1	HOLD005	1 Pair	Front Heavy Duty Torsion Bars	\$ 626.18
2	HJ-1	2	Rear Leaf Springs- Raised (B)	\$ 472.58
3	HJ-1HD	2	Rear Leaf Springs- Raised Heavy Duty (C)	\$ 497.33
4	N71104	1	Rear Urethane Bush Kit- Spring Front eye	\$ 61.90
5	N71021	2	Rear Urethane Bush Kit- Spring Rear eye/shackle	\$ 42.23
6	UBL-16	4	Rear U-Bolts	\$ 24.61
7	LGSKISZ-004	2	Rear Greasable Shackle	\$ 53.93
8	LGPKISZ-005	2	Rear Greasable Pin	\$ 60.19
9	6462543S	2	Front Gas Legend Shock Absorber	\$ 244.03
10	6462258B	2	Rear Gas Legend Shock Absorber	\$ 269.38

SUSPENSION KITS

Kit Type	Part No.	Qty. per vehicle	Kit Description	List Price EACH
B	HOLDKIT002-B	1	RAISED	\$ 3,071.17
C	HOLDKIT002-C	1	RAISED HEAVY DUTY	\$ 3,120.68

ACCESSORIES (Not included in Kit)

Item	Part No.	Qty. per vehicle	Accessory Description	List Price EACH
1A	N12102	1	Front Urethane Bush Kit- Steering Idler Bush	\$ 36.02
2A	N21200	1	Front Urethane Bush Kit- Sway Bar Link	\$ 40.29
3A	N52813	1	Front Urethane Bush Kit- Low Cont. Arm Inner	\$ 234.82
4A	N52811	1	Front Urethane Bush Kit- Upp. Cont. Arm Inner	\$ 260.41
5A	N21172	1	Front Urethane Bush Kit- Shock Absorber Upper	\$ 31.65
6A	N31062	1	Rear Urethane Bush Kit- Shock Absorber	\$ 25.77

Part No.	Load Rating	Description
All spring load ratings are an approximate only. Vehicle ride heights will vary depending on load and accessories fitted.		
HJ-1	0 to 100kg Constant Load	
HJ-1HD	100 to 150kg Constant Load	

HOLDEN- Jackaroo (Isuzu Trooper- EXPORT)
UBS 13,16,52 Wagon LWB
11/81-86
Torsion Bar/Leaf



KIT COMPONENTS

Item	Part No.	Qty. per vehicle	Description	List Price EACH
1	HOLD005	1 Pair	Front Heavy Duty Torsion Bars	\$ 626.18
2	HJ-2	2	Rear Leaf Springs- Raised (B)	\$ 482.04
3	HJ-2HD	2	Rear Leaf Springs- Raised Heavy Duty (C)	\$ 554.45
4	N71104	1	Rear Urethane Bush Kit- Spring Front eye	\$ 61.90
5	N71021	2	Rear Urethane Bush Kit- Spring Rear eye/shackle	\$ 42.23
6	UBL-16	4	Rear U-Bolts	\$ 24.61
7	LGSKISZ-004	2	Rear Greasable Shackle	\$ 53.93
8	LGPKISZ-005	2	Rear Greasable Pin	\$ 60.19
9	6462543S	2	Front Gas Legend Shock Absorber	\$ 244.03
10	6462258B	2	Rear Gas Legend Shock Absorber	\$ 269.38

SUSPENSION KITS

Kit Type	Part No.	Qty. per vehicle	Kit Description	List Price EACH
B	HOLDKIT003-B	1	RAISED	\$ 3,090.10
C	HOLDKIT003-C	1	RAISED HEAVY DUTY	\$ 3,234.93

ACCESSORIES (Not included in Kit)

Item	Part No.	Qty. per vehicle	Accessory Description	List Price EACH
1A	N12102	1	Front Urethane Bush Kit- Steering Idler Bush	\$ 36.02
2A	N21200	1	Front Urethane Bush Kit- Sway Bar Link	\$ 40.29
3A	N52813	1	Front Urethane Bush Kit- Low Cont. Arm Inner	\$ 234.82
4A	N52811	1	Front Urethane Bush Kit- Upp. Cont. Arm Inner	\$ 260.41
5A	N21172	1	Front Urethane Bush Kit- Shock Absorber Upper	\$ 31.65
6A	N31062	1	Rear Urethane Bush Kit- Shock Absorber	\$ 25.77

Part No.	Load Rating	Description
All spring load ratings are an approximate only. Vehicle ride heights will vary depending on load and accessories fitted.		
HJ-2	0 to 100kg Constant Load	
HJ-2HD	100 to 150kg Constant Load	

HOLDEN- Jackaroo (Isuzu Trooper- EXPORT)
UBS 16,17,52 Wagon SWB
11/86-91
Torsion Bar/Leaf

KIT COMPONENTS

Item	Part No.	Qty. per vehicle	Description	List Price EACH
1	HOLD007	1 Pair	Front Heavy Duty Torsion Bars	\$ 1,396.56
2	HJ-1	2	Rear Leaf Springs- Raised (B)	\$ 472.58
3	HJ-1HD	2	Rear Leaf Springs- Raised Heavy Duty (C)	\$ 497.33
4	N71104 (11/81-3/87 build date)	1	Rear Urethane Bush Kit- Spring Front eye	\$ 61.90
5	N71506 (4/87-4/92 build date)	1	Rear Urethane Bush Kit- Spring Front eye	\$ 79.05
6	N71021	2	Rear Urethane Bush Kit- Spring Rear eye/shackle	\$ 42.23
7	UBL-16	4	Rear U-Bolts	\$ 24.61
8	LGSKISZ-004	2	Rear Greasable Shackle	\$ 53.93
9	LGPKISZ-005	2	Rear Greasable Pin	\$ 60.19
10	64612545	2	Front Gas Legend Shock Absorber	\$ 244.03
11	6462572T	2	Rear Gas Legend Shock Absorber	\$ 244.03

SUSPENSION KITS

Kit Type	Part No.	Qty. per vehicle	Kit Description	List Price EACH
B	HOLDKIT004-B	1	RAISED	\$ 3,808.00
C	HOLDKIT004-C	1	RAISED HEAVY DUTY	\$ 3,857.51

ACCESSORIES (Not included in Kit)

Item	Part No.	Qty. per vehicle	Accessory Description	List Price EACH
1A	N21172	1	Front Urethane Bush Kit- Shock Absorber Upper	\$ 31.65
2A	N52811	1	Front Urethane Bush Kit- Control Arm- Upper Inner	\$ 260.41
3A	N31062	1	Rear Urethane Bush Kit- Shock Absorber	\$ 25.77

Part No.	Load Rating	Description
All spring load ratings are an approximate only. Vehicle ride heights will vary depending on load and accessories fitted.		
HJ-1	0 to 100kg Constant Load	
HJ-1HD	100 to 150kg Constant Load	

HOLDEN- Jackaroo (Isuzu Bighorn- EXPORT)
UBS 25 Wagon SWB and LWB
5/92-1/98
Torsion Bar/Coil

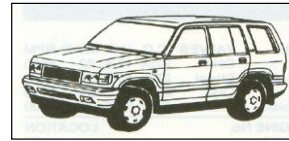

KIT COMPONENTS

Item	Part No.	Qty. per vehicle	Description	List Price EACH
1	HOLD009	1 Pair	Front Heavy Duty Torsion Bars	\$ 660.33
2	HRR-67	2	Rear Coil Springs- Raised (B)	\$ 126.26
3	HRR-67HD	2	Rear Coil Springs- Raised Heavy Duty (C)	\$ 126.26
4	64612545	2	Front Gas Legend Shock Absorber	\$ 244.03
5	6462540B	2	Rear Gas Legend Shock Absorber	\$ 244.03

SUSPENSION KITS

Kit Type	Part No.	Qty. per vehicle	Kit Description	List Price EACH
B	HOLDKIT006-B	1	RAISED	\$ 1,888.95
C	HOLDKIT006-C	1	RAISED HEAVY DUTY	\$ 1,888.95

ACCESSORIES (Not included in Kit)

Item	Part No.	Qty. per vehicle	Accessory Description	List Price EACH
1A	N21172	1	Front Urethane Bush Kit- Shock Absorber Upper	\$ 31.65
2A	N52811	1	Front Urethane Bush Kit- Control Arm- Upper Inner	\$ 260.41
3A	N31062	1	Rear Urethane Bush Kit- Shock Absorber	\$ 25.77

Part No.	Load Rating	Description
All spring load ratings are an approximate only. Vehicle ride heights will vary depending on load and accessories fitted.		
HRR-67	0 to 100kg Constant Load	
HRR-67HD	100 to 150kg Constant Load	

HOLDEN- Jackaroo (Isuzu Bighorn- EXPORT)
UBS 26, 69, 73 Wagon SWB and LWB
2/98 on
Torsion Bar/Coil

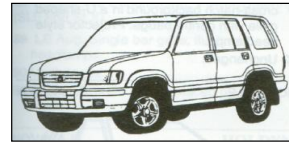

KIT COMPONENTS

Item	Part No.	Qty. per vehicle	Description	List Price EACH
1	HOLD009	1 Pair	Front Heavy Duty Torsion Bars	\$ 660.33
2	HRR-67HD	2	Rear Coil Springs- Raised (B)	\$ 126.26
3	HRR-67EHD	2	Rear Coil Springs- Raised Heavy Duty (C)	\$ 144.45
4	64612545	2	Front Gas Legend Shock Absorber	\$ 244.03
5	6462540B	2	Rear Gas Legend Shock Absorber	\$ 244.03

SUSPENSION KITS

Kit Type	Part No.	Qty. per vehicle	Kit Description	List Price EACH
B	HOLDKIT007-B	1	RAISED	\$ 1,888.95
C	HOLDKIT007-C	1	RAISED HEAVY DUTY	\$ 1,925.33

ACCESSORIES (Not included in Kit)

Item	Part No.	Qty. per vehicle	Accessory Description	List Price EACH
1A	N21172	1	Front Urethane Bush Kit- Shock Absorber Upper	\$ 31.65
2A	N52811	1	Front Urethane Bush Kit- Control Arm- Upper Inner	\$ 260.41
3A	N31062	1	Rear Urethane Bush Kit- Shock Absorber	\$ 25.77

Part No.	Load Rating	Description
All spring load ratings are an approximate only. Vehicle ride heights will vary depending on load and accessories fitted.		
HRR-67HD	100 to 150kg Constant Load	
HRR-67EHD	150 to 250kg Constant Load	

HOLDEN- Rodeo
KB, KBD, TFS, R7, R9
7/85-2/03
Torsion Bar/Leaf

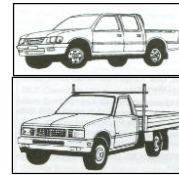

KIT COMPONENTS

Item	Part No.	Qty. per vehicle	Description	List Price EACH
1	HOLD005 (1983-1988 build date)	1 Pair	Front Heavy Duty Torsion Bars	\$ 626.18
2	HOLD005A (1988-2/2003 build date)	1 Pair	Front Heavy Duty Torsion Bars (1988-2/03)	\$ 530.35
3	HR-15	2	Rear Leaf Springs- Raised (B)	\$ 484.81
4	HR-15HD	2	Rear Leaf Springs- Raised Heavy Duty (C)	\$ 580.71
5	N71506	1	Rear Urethane Bush Kit- Spring Front eye	\$ 79.05
6	N71021	2	Rear Urethane Bush Kit- Spring Rear eye/shackle	\$ 42.23
7	UBL-18	4	Rear U-Bolts	\$ 24.61
8	LGSKISZ-004	2	Rear Greasable Shackle (7/85-88 build date)	\$ 53.93
9	LGSK386	2	Rear Greasable Shackle (88-2/03 build date)	\$ 53.93
10	LGPKISZ-005	2	Rear Greasable Pin	\$ 60.19
11	64612545	2	Front Gas Legend Shock Absorber	\$ 244.03
12	6462258B	2	Rear Gas Legend Shock Absorber	\$ 269.38

SUSPENSION KITS

Kit Type	Part No.	Qty. per vehicle	Kit Description	List Price EACH
B	HOLDKIT008-B	1	RAISED	\$ 3,112.78
C	HOLDKIT008-C	1	RAISED HEAVY DUTY	\$ 3,304.59

ACCESSORIES (Not included in Kit)

Item	Part No.	Qty. per vehicle	Accessory Description	List Price EACH
1A	N21172	1	Front Urethane Bush Kit- Shock Absorber Upper	\$ 31.65
2A	N52811 (Suits 6/88 to 2/03 build date only)	1	Front Urethane Bush Kit- Control Arm- Upper Inner	\$ 260.41

Part No.	Load Rating	Description
All spring load ratings are an approximate only. Vehicle ride heights will vary depending on load and accessories fitted.		
HR-15	0 to 100kg Constant Load	
HR-15HD	150 to 250kg Constant Load	

HOLDEN- Rodeo
RA Dual Cab
3/03-8/08
Torsion Bar/Leaf

KIT COMPONENTS

Item	Part No.	Qty. per vehicle	Description	List Price EACH
1	HOLD010	1 Pair	Front Heavy Duty Torsion Bars	\$ 660.33
2	HR-17	2	Rear Leaf Springs- Raised (B)	\$ 520.44
3	HR-17HD	2	Rear Leaf Springs- Raised Heavy Duty (C)	\$ 685.71
4	N71506	1	Rear Urethane Bush Kit- Spring Front eye	\$ 79.05
5	N71021	2	Rear Urethane Bush Kit- Spring Rear eye/shackle	\$ 42.23
6	UBL-50	4	Rear U-Bolts	\$ 24.61
7	LGSKISZ-004	2	Rear Greasable Shackle	\$ 53.93
8	LGPK387-2	2	Rear Greasable Pin	\$ 47.08
9	64612545	2	Front Gas Legend Shock Absorber	\$ 244.03
10	6462258B	2	Rear Gas Legend Shock Absorber	\$ 269.38

SUSPENSION KITS

Kit Type	Part No.	Qty. per vehicle	Kit Description	List Price EACH
B	HOLDKIT010-B	1	RAISED	\$ 3,191.99
C	HOLDKIT010-C	1	RAISED HEAVY DUTY	\$ 3,522.53

ACCESSORIES (Not included in Kit)

Item	Part No.	Qty. per vehicle	Accessory Description	List Price EACH
1A	N21172	1	Front Urethane Bush Kit- Shock Absorber Upper	\$ 31.65

Part No.	Load Rating	Description
All spring load ratings are an approximate only. Vehicle ride heights will vary depending on load and accessories fitted.		
HR-17	0 to 100kg Constant Load	
HR-17HD	150 to 250kg Constant Load	

HYUNDAI- Terracan
HP Wagon
11/01 on
Torsion Bar/Coil



KIT COMPONENTS

Item	Part No.	Qty. per vehicle	Description	List Price EACH
1	HYUND004	1 Pair	Front Heavy Duty Torsion Bars	\$ 903.21
2	HRS-520	2	Rear Coil Springs- Standard Height (A)	\$ 126.26
3	HRR-520	2	Rear Coil Springs- Raised (B)	\$ 126.26
4	HRR-520HD	2	Rear Coil Springs- Raised Heavy Duty (C)	\$ 126.26
5	6462543S	2	Front Gas Legend Shock Absorber	\$ 244.03
6	64612091E	2	Rear Gas Legend Shock Absorber	\$ 244.03

SUSPENSION KITS

Kit Type	Part No.	Qty. per vehicle	Kit Description	List Price EACH
A	HYUNKIT001-A	1	STANDARD HEIGHT	\$ 2,131.83
B	HYUNKIT001-B	1	RAISED	\$ 2,131.83
C	HYUNKIT001-C	1	RAISED HEAVY DUTY	\$ 2,131.83

Part No.	Load Rating	Description
All spring load ratings are an approximate only. Vehicle ride heights will vary depending on load and accessories fitted.		
HRS-520	0 to 100kg Constant Load	
HRR-520	0 to 100kg Constant Load	
HRR-520HD	100 to 150kg Constant Load	

ISUZU- D Max
MY09 Single Cab/Xtra Cab
10/08-12/11
Torsion Bar/Leaf

KIT COMPONENTS

Item	Part No.	Qty. per vehicle	Description	List Price EACH
1	HOLD010	1 Pair	Front Heavy Duty Torsion Bars	\$ 660.33
2	HR-18SH	2	Rear Leaf Springs- Standard (A)	\$ 661.59
3	HR-18	2	Rear Leaf Springs- Raised (B)	\$ 690.99
4	HR-18HD	2	Rear Leaf Springs- Raised Heavy Duty (C)	\$ 766.34
5	N71506	1	Rear Urethane Bush Kit- Spring Front eye	\$ 79.05
6	N71021	2	Rear Urethane Bush Kit- Spring Rear eye/shackle	\$ 42.23
7	UBL-50	4	Rear U-Bolts	\$ 24.61
8	LGSKISZ-004	2	Rear Greasable Shackle	\$ 53.93
9	LGPK387-2	2	Rear Greasable Pin	\$ 47.08
10	64612545	2	Front Gas Legend Shock Absorber	\$ 244.03
11	6462258B	2	Rear Gas Legend Shock Absorber	\$ 269.38

SUSPENSION KITS

Kit Type	Part No.	Qty. per vehicle	Kit Description	List Price EACH
A	ISUZKIT001-A	1	STANDARD HEIGHT	\$ 3,474.29
B	ISUZKIT001-B	1	RAISED	\$ 3,533.09
C	ISUZKIT001-C	1	RAISED HEAVY DUTY	\$ 3,683.79

ACCESSORIES (Not included in Kit)

Item	Part No.	Qty. per vehicle	Accessory Description	List Price EACH
1A	N21172	1	Front Urethane Bush Kit- Shock Absorber Upper	\$ 31.65

Part No.	Load Rating	Description
All spring load ratings are an approximate only. Vehicle ride heights will vary depending on load and accessories fitted.		
HR-18SH	0 to 100kg Constant Load	
HR-18	0 to 100kg Constant Load	
HR-18HD	150 to 250kg Constant Load	

ISUZU- D Max
MY09 Dual Cab
10/08-12/11
Torsion Bar/Leaf

KIT COMPONENTS

Item	Part No.	Qty. per vehicle	Description	List Price EACH
1	HOLD010	1 Pair	Front Heavy Duty Torsion Bars	\$ 660.33
2	HR-18DC	2	Rear Leaf Springs- Standard (A)	\$ 458.64
3	HR-18SH	2	Rear Leaf Springs- Raised (B)	\$ 661.59
4	HR-18	2	Rear Leaf Springs- Raised Heavy Duty (C)	\$ 690.99
5	N71506	1	Rear Urethane Bush Kit- Spring Front eye	\$ 79.05
6	N71021	2	Rear Urethane Bush Kit- Spring Rear eye/shackle	\$ 42.23
7	UBL-50	4	Rear U-Bolts	\$ 24.61
8	LGSKISZ-004	2	Rear Greasable Shackle	\$ 53.93
9	LGPK387-2	2	Rear Greasable Pin	\$ 47.08
10	64612545	2	Front Gas Legend Shock Absorber	\$ 244.03
11	6462258B	2	Rear Gas Legend Shock Absorber	\$ 269.38

SUSPENSION KITS

Kit Type	Part No.	Qty. per vehicle	Kit Description	List Price EACH
A	ISUZKIT002-A	1	STANDARD HEIGHT	\$ 3,068.39
B	ISUZKIT002-B	1	RAISED	\$ 3,474.29
C	ISUZKIT002-C	1	RAISED HEAVY DUTY	\$ 3,533.09

ACCESSORIES (Not included in Kit)

Item	Part No.	Qty. per vehicle	Accessory Description	List Price EACH
1A	N21172	1	Front Urethane Bush Kit- Shock Absorber Upper	\$ 31.65

Part No.	Load Rating	Description
All spring load ratings are an approximate only. Vehicle ride heights will vary depending on load and accessories fitted.		
HR-18DC	0 to 100kg Constant Load	
HR-18	0 to 100kg Constant Load	
HR-18HD	150 to 250kg Constant Load	

ISUZU- D Max
MY12 Single Cab, Xtra Cab and Dual Cab 4x4 model
06/12-6/2020
Coil/Leaf

KIT COMPONENTS

Item	Part No.	Qty. per vehicle	Description	List Price EACH
1	IFS-002	2	Front Coil Springs- Standard Height (A)	\$ 126.26
2	IFR-002	2	Front Coil Springs- Raised (B)	\$ 126.26
3	IFR-002HD	2	Front Coil Springs- Raised Heavy Duty (C)	\$ 126.26
4	IS-003SH	2	Rear Leaf Springs- Standard (B)	\$ 677.23
5	IS-003	2	Rear Leaf Springs- Raised (B)	\$ 639.99
6	IS-003HD	2	Rear Leaf Springs- Raised Heavy Duty (C)	\$ 799.99
7	N73254	1	Rear Urethane Bush Kit- Spring Front eyes	\$ 83.71
8	N73255	1	Rear Urethane Bush Kit- Spring Front eyes/shackle	\$ 110.28
9	UBL-06	4	Rear U-Bolts	\$ 24.61
10	LGSK386/3	2	Rear Greasable Shackle Kit	\$ 53.93
11	LGPK387-2	2	Rear Pin Kit (Non Greasable)	\$ 47.08
12	64611038	2	Front Gas Legend Strut	\$ 329.07
13	6462258B	2	Rear Gas Legend Shock Absorber	\$ 269.38
14	64611038LH-2.0ADJMONO	1	Front 2.0" Mono Tube Strut with Remote Reservoir (Platinum)	\$ 720.65
15	64611038RH-2.0ADJMONO	1	Front 2.0" Mono Tube Strut with Remote Reservoir (Platinum)	\$ 720.65
16	6462258B-2.0ADJMONO	2	Rear 2.0" Mono Tube Strut with Remote Reservoir (Platinum)	\$ 678.59

SUSPENSION KITS

Kit Type	Part No.	Qty. per vehicle	Kit Description	List Price EACH
A	ISUZKIT003-A	1	STANDARD	\$ 3,298.33
B	ISUZKIT003-B	1	RAISED	\$ 3,223.86
C	ISUZKIT003-C	1	RAISED HEAVY DUTY	\$ 3,543.85
A Platinum	ISUZKIT003-A-PLAT	1	STANDARD	\$ 4,899.90
B Platinum	ISUZKIT003-B-PLAT	1	RAISED	\$ 4,825.42
C Platinum	ISUZKIT003-C-PLAT	1	RAISED HEAVY DUTY	\$ 5,145.42

ISUZU- D Max
MY12 Single Cab, Xtra Cab and Dual Cab 4x4 model
06/12-6/2020
Coil/Leaf

MINING VEHICLE KIT

KIT COMPONENTS

Item	Part No.	Qty. per vehicle	Description	List Price EACH
1	IFR-002	2	Front Coil Springs	\$ 126.26
2	IS-003HD	2	Rear Leaf Springs- Raised Heavy Duty	\$ 799.99
3	N73254	1	Rear Urethane Bush Kit- Spring Front eyes	\$ 83.71
4	N73255	1	Rear Urethane Bush Kit- Spring rear eyes/shackle	\$ 110.28
5	UBL-06	4	Rear U-Bolts	\$ 24.61
6	LGSK386/3	2	Rear Greasable Shackle Kit	\$ 53.93
7	LGPK387-2	2	Rear Pin Kit (Non Greasable)	\$ 47.08
8	64611038	2	Front Gas Legend Strut	\$ 329.07
9	6462258B	2	Rear Gas Legend Shock Absorber	\$ 269.38

SUSPENSION KITS

Kit Type	Part No.	Qty. per vehicle	Kit Description	List Price EACH
M	ISUZKIT004-M	1	RAISED HEAVY DUTY	\$ 3,543.85

Part No.	Load Rating	Description
All spring load ratings are an approximate only. Vehicle ride heights will vary depending on load and accessories fitted.		
IFS-002	0 to 100kg Constant Load	Suits Steel Bull Bar
IFR-002	0 to 100kg Constant Load	Suits Steel Bull Bar
IFR-002HD	100 to 150kg Constant Load	Suits Steel Bull Bar, Winch, Underbody Protection etc.
IS-003SH	0 to 100kg Constant Load	
IS-003	0 to 100kg Constant Load	
IS-003HD	150 to 250kg Constant Load	

ISUZU- D Max
MY12 Single Cab, Xtra Cab and Dual Cab 4x4 model
06/12-6/2020
Coil/Leaf

3600KG GVM Upgrade Kit (Fitted Price)-State Compliance

KIT COMPONENTS

Item	Part No.	Qty. per vehicle	Description	SOLD AS KIT ONLY
1	IFR-002	2	Front Coil Springs	
2	IS-003EHD	2	Rear Leaf Springs	
3	N73254	1	Rear Urethane Bush Kit- Spring Front eyes	
4	N73255	1	Rear Urethane Bush Kit- Shackle Bush Kit	
5	UBL-06	4	Rear U-Bolts	
6	LGSK386/3	2	Rear Greasable Shackle Kit	
7	LGPk387-2	2	Rear Greasable Pin Kit	
8	64611038	2	Front Gas Legend Strut	
9	6462258B	2	Rear Gas Legend Shock Absorber	
10	BLEB001	1	Brake Line extension Bracket	
11	77ACMB-LCSAHARA-GVM-IND	2	Category 6 Indicators ADR 13/00	
12		2	Lovells Rear Mudflaps	

SUSPENSION KITS

Kit Type	Part No.	Qty. per vehicle	Kit Description	Retail Price
GVM	ISUZKIT006-GVM	1	GVM Upgrade Kit (Fitted Price)	\$ 5,200.00

NOTE: Fitted Price plus GST

Part No.	Load Rating	Description
All spring load ratings are an approximate only. Vehicle ride heights will vary depending on load and accessories fitted.		
IFR-002	0 to 100kg Constant Load	Suits Steel Bull Bar
IS-003EHD	400 to 500kg Constant Load	To GVM

*****NOTE: The above GVM Upgrade Kit for Federal Compliance under Second Stage Manufacturer Approval, with a Federal compliance plate, is no longer available**
The above kit can still be supplied under State Compliance and will require inspection, by a Lovells endorsed signatory and /or Production Facility.
Consult your nearest Lovells Production facility for Individual State requirements.

ISUZU- D Max

MY21 Single Cab, Xtra Cab and Dual Cab 4x4 model

7/2020 on

Coil/Leaf

KIT COMPONENTS

Item	Part No.	Qty. per vehicle	Description	List Price EACH
1	IFS-002	2	Front Coil Springs- Standard Height (A)	\$ 126.26
2	IFR-002	2	Front Coil Springs- Raised (B)	\$ 126.26
3	IFR-002HD	2	Front Coil Springs- Raised Heavy Duty (C & D)	\$ 126.26
4	IS-003SH	2	Rear Leaf Springs- Standard (A)	\$ 677.23
5	IS-003	2	Rear Leaf Springs- Raised (B)	\$ 639.99
6	IS-003HD	2	Rear Leaf Springs- Raised Heavy Duty (C)	\$ 799.99
7	IS-003EHD	2	Rear Leaf Springs- Raised Extra Heavy Duty (D)	\$ 914.27
8	N73254	1	Rear Urethane Bush Kit- Spring Front Eyes	\$ 83.71
9	N73474	1	Rear Urethane Bush Kit- Rear Top Shackle	\$ 59.66
10	N71021	1	Rear Urethane Bush Kit- Rear Spring Eye	\$ 42.23
11	UBL-06	4	Rear U-Bolts	\$ 24.61
12	LGSK393	2	Rear Greasable Shackle Kit	\$ 74.63
13	LGPK387-2	2	Rear Pin Kit (Non Greasable)	\$ 47.08
14	64611038	2	Front Gas Legend Strut	\$ 329.07
15	6462258B	2	Rear Gas Legend Shock Absorber	\$ 269.38

SUSPENSION KITS

Kit Type	Part No.	Qty. per vehicle	Kit Description	List Price EACH
A	ISUZKIT005-A	1	STANDARD	\$ 3,289.12
B	ISUZKIT005-B	1	RAISED	\$ 3,214.64
C	ISUZKIT005-C	1	RAISED HEAVY DUTY	\$ 3,534.64
D	ISUZKIT005-D	1	RAISED EXTRA HEAVY DUTY	\$ 3,805.43

Optional parts

Item	Part No.	Qty. per vehicle	Option Description	List Price EACH
1A	LOVUCA-D/MAX	1	Lovells Extreme Upper Control Arm kit	\$ 995.00
2A	LPWR110402	1	Lovells Radiator Closemesh	\$ 2,600.00

ACCESSORIES (Not included in Kit)

Item	Part No.	Qty. per vehicle	Accessory Description	List Price EACH
1A	BLEB001	1	Brake Line Extension Bracket	\$ 31.51

Part No.	Load Rating	Description
All spring load ratings are an approximate only. Vehicle ride heights will vary depending on load and accessories fitted.		
IFS-002	0 to 100kg Constant Load	Suits Steel Bull Bar
IFR-002	0 to 100kg Constant Load	Suits Steel Bull Bar
IFR-002HD	100 to 150kg Constant Load	Suits Steel Bull Bar, Winch, Underbody Protection etc.
IS-003SH	0 to 100kg Constant Load	
IS-003	0 to 100kg Constant Load	
IS-003HD	150 to 250kg Constant Load	
IS-003EHD	400 to 500kg Constant Load	

ISUZU- D Max
MY21 Single Cab, Xtra Cab and Dual Cab 4x4 model
7/2020 on
Coil/Leaf

3600KG GVM Upgrade Kit (Fitted Price)-Federal Compliance

KIT COMPONENTS

Item	Part No.	Qty. per vehicle	Description	SOLD AS KIT ONLY
1	IFS-002	2	HD Front Coil Springs- Standard Height (Option 1) Vehicles with minimal load bearing front accessories. Axle Capacities under 1300kg	
2	IFR-002	2	HD Front Coil Springs- Raised (Option 2) Vehicles with load bearing accessories, i.e. Steel Bull bar, Winch, Dual Batteries	
3	IS-003EHD	2	Rear Leaf Springs- Raised Extra Heavy Duty	
4	N73254	1	Rear Urethane Bush Kit- Spring Front Eyes	
5	N73474	1	Rear Urethane Bush Kit- Rear Top Shackle	
6	N71021	1	Rear Urethane Bush Kit- Rear Spring Eye	
7	UBL-06	4	Rear U-Bolts	
8	LGSK393	2	Rear Greasable Shackle Kit	
9	LGPK387-2	2	Rear Pin Kit (Non Greasable)	
10	64611038	2	Front Gas Legend Strut	
11	6462258B	2	Rear Gas Legend Shock Absorber	
12	BLEB001	1	Brake Line Extension Bracket	
13	77ACMB-LCSAHARA-GVM-IND	2	Category 6 Indicators ADR 13/00	
14		2	Lovells Rear Mudflaps	
15		1	Federal Compliance plate with revised GVM (Pre-registered Vehicles)	
16		1	Re-Tension U-Bolts Warning Decal	
17		1	Tyre Loading Placard with revised axle capacities	
18		1	GVM Upgrade Owners Manual	
19		1	Fitting Instruction Manual	

SUSPENSION KITS

Kit Type	Part No.	Qty. per vehicle	Kit Description	List Price EACH
GVM	ISUZKIT008-GVM	1	GVM Upgrade Kit (Fitted Price)	\$ 5,200.00

Optional parts

Item	Part No.	Qty. per vehicle	Option Description	List Price EACH
1A	LOVUCA-D/MAX	1	Lovells Extreme Upper Control Arm kit	\$ 995.00
2A	LPWR110402	1	Lovells Radiator Closemesh	\$ 2,600.00
3A	77ACMB-D/MAX	1	Patch Harness for Models with Bi LED Headlights	\$ 228.43

Part No.	Load Rating	Description
All spring load ratings are an approximate only. Vehicle ride heights will vary depending on load and accessories fitted.		
IFS-002	0 to 100kg Constant Load	Suits Steel Bull Bar
IFR-002	0 to 100kg Constant Load	Suits Steel Bull Bar, Winch, Underbody Protection etc.
IS-003EHD	400 to 500kg Constant Load	To GVM

The solution for owners/managers of Isuzu D Max 4x4 vehicles who have a need to carry loads to a GVM of 3600kg (up from 3100kg standard GVM), while at the same time meeting the practical and documentary compliance requirements of Work Safety, Police Licensing, Insurance, Lessors and Fleet Managers.
 This kit is approved by the Australian Government's Department of Infrastructure, Transport, Regional Development and Communications Manufacturers compliance plate. (Australian Compliance ONLY)

Lovells Compliance Plate Approval Number (CPA) 51523

Above price includes fitting by a Lovells Authorised Fitter and does not include GST

ISUZU- D Max
MY21 Single Cab, Xtra Cab and Dual Cab 4x4 model
7/2020 on
Coil/Leaf

3600KG GVM Upgrade Kit (Fitted Price)-Federal Compliance

KIT COMPONENTS

Item	Part No.	Qty. per vehicle	Description	SOLD AS KIT ONLY
1	IFS-002	2	HD Front Coil Springs- Standard Height (Option 1) Vehicles with minimal load bearing front accessories. Axle Capacities under 1300kg	
2	IFR-002	2	HD Front Coil Springs- Raised (Option 2) Vehicles with load bearing accessories, i.e. Steel Bull bar, Winch, Dual Batteries	
3	IS-003EHD	2	Rear Leaf Springs- Raised Extra Heavy Duty	
4	N73254	1	Rear Urethane Bush Kit- Spring Front Eyes	
5	N73474	1	Rear Urethane Bush Kit- Rear Top Shackle	
6	N71021	1	Rear Urethane Bush Kit- Rear Spring Eye	
7	UBL-06	4	Rear U-Bolts	
8	LGSK393	2	Rear Greasable Shackle Kit	
9	LGPK387-2	2	Rear Pin Kit (Non Greasable)	
10	64611038LH-2.0ADJMONO	1	Front 2.0" Mono Tube Strut with Remote Reservoir	
11	64611038RH-2.0ADJMONO	1	Front 2.0" Mono Tube Strut with Remote Reservoir	
12	6462258B-2.0ADJMONO	2	Rear 2.0" Mono Tube Strut with Remote Reservoir	
13	BLEB001	1	Brake Line Extension Bracket	
14	77ACMB-LCSAHARA-GVM-IND	2	Category 6 Indicators ADR 13/00	
15		2	Lovells Rear Mudflaps	
16		1	Federal Compliance plate with revised GVM (Pre-registered Vehicles)	
17		1	Re-Tension U-Bolts Warning Decal	
18		1	Tyre Loading Placard with revised axle capacities	
19		1	GVM Upgrade Owners Manual	
20		1	Fitting Instruction Manual	

SUSPENSION KITS

Kit Type	Part No.	Qty. per vehicle	Kit Description	List Price EACH
GVM	ISUZKIT008-GVM-PLAT	1	GVM Upgrade Kit (Fitted Price)	\$ 5,700.00

Optional parts

Item	Part No.	Qty. per vehicle	Option Description	List Price EACH
1A	LOVUCA-D/MAX	1	Lovells Extreme Upper Control Arm kit	\$ 995.00
2A	LPWR110402	1	Lovells Radiator Closemesh	\$ 2,600.00
3A	77ACMB-D/MAX	1	Patch Harness for Models with Bi LED Headlights	\$ 228.43

Part No.	Load Rating	Description
All spring load ratings are an approximate only. Vehicle ride heights will vary depending on load and accessories fitted.		
IFS-002	0 to 100kg Constant Load	Suits Steel Bull Bar
IFR-002	0 to 100kg Constant Load	Suits Steel Bull Bar, Winch, Underbody Protection etc.
IS-003EHD	400 to 500kg Constant Load	To GVM

The solution for owners/managers of Isuzu D Max 4x4 vehicles who have a need to carry loads to a GVM of 3600kg (up from 3100kg standard GVM), while at the same time meeting the practical and documentary compliance requirements of Work Safety, Police Licensing, Insurance, Lessors and Fleet Managers.

This kit is approved by the Australian Government's Department of Infrastructure, Transport, Regional Development and Communications Manufacturers compliance plate. (Australian Compliance ONLY)

Lovells Compliance Plate Approval Number (CPA) 51523

Above price includes fitting by a Lovells Authorised Fitter and does not include GST

ISUZU- MU-X
MY15 Wagon
01/15-6/21
Coil/Coil

KIT COMPONENTS

Item	Part No.	Qty. per vehicle	Description	List Price EACH
1	TFR-118	2	Front Coil Springs- Raised (B)	\$ 126.26
2	TFR-118HD	2	Front Coil Springs- Raised Heavy Duty (C)	\$ 126.26
3	IRR-003	2	Rear Coil Springs- Raised (B)	\$ 126.26
4	IRR-003HD	2	Rear Coil Springs- Raised Heavy Duty (C)	\$ 126.26
5	64611038	2	Front Gas Legend Strut	\$ 329.07
6	64611046	2	Rear Gas Legend Shock Absorber	\$ 244.03

SUSPENSION KITS

Kit Type	Part No.	Qty. per vehicle	Kit Description	List Price EACH
B	ISUZKIT007-B	1	RAISED	\$ 1,651.24
C	ISUZKIT007-C	1	RAISED HEAVY DUTY	\$ 1,651.24

NOTE: Lovells front coil springs will not fit struts with a rolled lower spring seat. For correct fitment always use with a Lovells strut.

Part No.	Load Rating	Description
All spring load ratings are an approximate only. Vehicle ride heights will vary depending on load and accessories fitted.		
TFR-118	0 to 100kg Constant Load	Suits Steel Bull Bar
TFR-118HD	150 to 200kg Constant Load	Suits Steel Bull Bar, Winch, Underbody Protection etc.
IRR-003	0 to 100kg Constant Load	
IRR-003HD	150 to 250kg Constant Load	

ISUZU- MU-X
MY15 Wagon
7/21-on
Coil/Coil

KIT COMPONENTS

Item	Part No.	Qty. per vehicle	Description	List Price EACH
1	TFR-118	2	Front Coil Springs- Raised (B)	\$ 126.26
2	TFR-118HD	2	Front Coil Springs- Raised Heavy Duty (C)	\$ 126.26
3	IRR-003HD	2	Rear Coil Springs- Raised (B)	\$ 126.26
4	IRR-003EHD	2	Rear Coil Springs- Raised Heavy Duty (C)	\$ 126.26
5	64611038	2	Front Gas Legend Strut	\$ 329.07
6	64611046	2	Rear Gas Legend Shock Absorber	\$ 244.03

SUSPENSION KITS

Kit Type	Part No.	Qty. per vehicle	Kit Description	List Price EACH
B	ISUZKIT011-B	1	RAISED	\$ 1,651.24
C	ISUZKIT011-C	1	RAISED HEAVY DUTY	\$ 1,651.24

NOTE: Lovells front coil springs will not fit struts with a rolled lower spring seat. For correct fitment always use with a Lovells strut.

Part No.	Load Rating	Description
All spring load ratings are an approximate only. Vehicle ride heights will vary depending on load and accessories fitted.		
TFR-118	0 to 100kg Constant Load	Suits Steel Bull Bar
TFR-118HD	150 to 200kg Constant Load	Suits Steel Bull Bar, Winch, Underbody Protection etc.
IRR-003HD	0 to 100kg Constant Load	
IRR-003EHD	150 to 250kg Constant Load	

JEEP- Cherokee-SPORT
XJ Wagon (Petrol & Diesel)
4/94-8/01
Coil/Leaf

KIT COMPONENTS

Item	Part No.	Qty. per vehicle	Description	List Price EACH
1	CFR-52	2	Front Coil Springs- Raised (B)	\$ 126.26
2	AJ-12	2	Rear Leaf Springs- Raised (B)	\$ 442.26
3	64611032	2	Front Gas Legend Shock Absorber	\$ 244.03
4	64611033	2	Rear Gas Legend Shock Absorber	\$ 244.03

SUSPENSION KITS

Kit Type	Part No.	Qty. per vehicle	Kit Description	List Price EACH
B	JEEPKIT010-B	1	RAISED	\$ 2,113.14

STEERING DAMPERS (Not included in Kit)

Item	Part No.	Qty. per vehicle	Description	List Price EACH
1B	5450001	1	Steering Damper Assembly- Heavy Duty	\$ 161.74
2B	5450001-RTC	1	Steering Damper Assembly- Return to Centre	\$ 202.68

Part No.	Load Rating	Description
All spring load ratings are an approximate only. Vehicle ride heights will vary depending on load and accessories fitted.		
CFR-52	0 to 100kg Constant Load	Suits Steel Bull Bar
AJ-12	0 to 100kg Constant Load	

JEEP- Cherokee-LIMITED
XJ Wagon (Petrol & Diesel)
4/94-8/01
Coil/Leaf

KIT COMPONENTS

Item	Part No.	Qty. per vehicle	Description	List Price EACH
1	CFR-33	2	Front Coil Springs- Raised (B)	\$ 126.26
2	AJ-10	2	Rear Leaf Springs- Raised (B)	\$ 488.92
3	64611032	2	Front Gas Legend Shock Absorber	\$ 244.03
4	64611033	2	Rear Gas Legend Shock Absorber	\$ 244.03

SUSPENSION KITS

Kit Type	Part No.	Qty. per vehicle	Kit Description	List Price EACH
B	JEEPKIT011-B	1	RAISED	\$ 2,206.46

STEERING DAMPERS (Not included in Kit)

Item	Part No.	Qty. per vehicle	Description	List Price EACH
1B	5450001	1	Steering Damper Assembly- Heavy Duty	\$ 161.74
2B	5450001-RTC	1	Steering Damper Assembly- Return to Centre	\$ 202.68

Part No.	Load Rating	Description
All spring load ratings are an approximate only. Vehicle ride heights will vary depending on load and accessories fitted.		
CFR-33	0 to 100kg Constant Load	Suits Steel Bull Bar
AJ-10	0 to 100kg Constant Load	

JEEP- Cherokee
KJ Wagon
9/01-1/08
Coil/Coil

KIT COMPONENTS

Item	Part No.	Qty. per vehicle	Description	List Price EACH
1	CFR-106	2	Front Coil Springs- Raised (B)	\$ 126.26
2	CFR-106HD	2	Front Coil Springs- Raised Heavy Duty (C)	\$ 126.26
3	CRR-107	2	Rear Coil Springs- Raised (B)	\$ 126.26
4	CRR-107HD	2	Rear Coil Springs- Raised Heavy Duty (C)	\$ 126.26
5	64611018	2	Front Gas Legend Strut	\$ 270.25
6	64611019	2	Rear Gas Legend Shock Absorber	\$ 244.03

SUSPENSION KITS

Kit Type	Part No.	Qty. per vehicle	Kit Description	List Price EACH
B	JEEPKIT001-B	1	RAISED	\$ 1,533.59
C	JEEPKIT001-C	1	RAISED HEAVY DUTY	\$ 1,533.59

Part No.	Load Rating	Description
All spring load ratings are an approximate only. Vehicle ride heights will vary depending on load and accessories fitted.		
CFR-106	0 to 100kg Constant Load	Suits Steel Bull Bar
CFR-106HD	100 to 150kg Constant Load	Suits Steel Bull Bar, Winch, Underbody Protection etc.
CRR-107	0 to 100kg Constant Load	
CRR-107HD	150 to 250kg Constant Load	

JEEP- Cherokee
KK Wagon
2/08 on
Coil/Coil

KIT COMPONENTS

Item	Part No.	Qty. per vehicle	Description	List Price EACH
1	CFR-67	2	Front Coil Springs- Raised (B)	\$ 126.26
2	CRR-68	2	Rear Coil Springs- Raised (B)	\$ 126.26
3	64611018	2	Front Gas Legend Strut	\$ 270.25
4	64611019	2	Rear Gas Legend Shock Absorber	\$ 244.03

SUSPENSION KITS

Kit Type	Part No.	Qty. per vehicle	Kit Description	List Price EACH
B	JEEPKIT008-B	1	RAISED	\$ 1,533.59

Part No.	Load Rating	Description
All spring load ratings are an approximate only. Vehicle ride heights will vary depending on load and accessories fitted.		
CFR-67	0 to 100kg Constant Load	Suits Steel Bull Bar
CRR-68	0 to 100kg Constant Load	

JEEP- Grand Cherokee
ZJ Wagon
1992-5/99
Coil/Coil

KIT COMPONENTS

Item	Part No.	Qty. per vehicle	Description	List Price EACH
1	CFR-58	2	Front Coil Springs- Raised (B)	\$ 126.26
2	CRR-59	2	Rear Coil Springs- Raised (B)	\$ 126.26
3	64611028	2	Front Gas Legend Shock Absorber	\$ 244.03
4	64611029	2	Rear Gas Legend Shock Absorber	\$ 244.03

SUSPENSION KITS

Kit Type	Part No.	Qty. per vehicle	Kit Description	List Price EACH
B	JEEPKIT009-B	1	RAISED	\$ 1,481.15

STEERING DAMPERS (Not included in Kit)

Item	Part No.	Qty. per vehicle	Description	List Price EACH
1B	5450001	1	Steering Damper Assembly- Heavy Duty	\$ 161.74
2B	5450001-RTC	1	Steering Damper Assembly- Return to Centre	\$ 202.68

Part No.	Load Rating	Description
All spring load ratings are an approximate only. Vehicle ride heights will vary depending on load and accessories fitted.		
CFR-58	0 to 100kg Constant Load	Suits Steel Bull Bar
CRR-59	0 to 100kg Constant Load	

JEEP- Grand Cherokee
WJ,WG Wagon
6/99-6/05
Coil/Coil

KIT COMPONENTS

Item	Part No.	Qty. per vehicle	Description	List Price EACH
1	CFS-62	2	Front Coil Springs- Standard Height (A)	\$ 126.26
2	CFR-62	2	Front Coil Springs- Raised (B)	\$ 126.26
3	CFR-62HD	2	Front Coil Springs- Raised Heavy Duty (C)	\$ 126.26
4	CRS-63	2	Rear Coil Springs- Standard Height (A)	\$ 126.26
5	CRR-63	2	Rear Coil Springs- Raised (B)	\$ 126.26
6	CRR-63HD	2	Rear Coil Springs- Raised Heavy Duty (C)	\$ 126.26
7	64611024	2	Front Gas Legend Shock Absorber	\$ 244.03
8	64611025	2	Rear Gas Legend Shock Absorber	\$ 244.03

SUSPENSION KITS

Kit Type	Part No.	Qty. per vehicle	Kit Description	List Price EACH
A	JEEPKIT004-A	1	STANDARD HEIGHT	\$ 1,481.14
B	JEEPKIT004-B	1	RAISED	\$ 1,481.14
C	JEEPKIT004-C	1	RAISED HEAVY DUTY	\$ 1,481.14

Part No.	Load Rating	Description
All spring load ratings are an approximate only. Vehicle ride heights will vary depending on load and accessories fitted.		
CFS-62	0 to 100kg Constant Load	Suits Steel Bull Bar
CFR-62	0 to 100kg Constant Load	Suits Steel Bull Bar
CFR-62HD	100 to 150kg Constant Load	Suits Steel Bull Bar, Winch, Underbody Protection etc.
CRS-63	0 to 100kg Constant Load	
CRR-63	0 to 100kg Constant Load	
CRR-63HD	100 to 150kg Constant Load	

JEEP- Grand Cherokee
WH,WK Wagon
7/05-12/10
Coil/Coil

KIT COMPONENTS

Item	Part No.	Qty. per vehicle	Description	List Price EACH
1	CFR-104	2	Front Coil Springs- Raised (B)	\$ 126.26
2	CFR-104HD	2	Front Coil Springs- Raised Heavy Duty (C)	\$ 126.26
3	CRR-105	2	Rear Coil Springs- Raised (B)	\$ 126.26
4	CRR-105HD	2	Rear Coil Springs- Raised Heavy Duty (C)	\$ 130.70
5	64611020	2	Front Gas Legend Strut	\$ 321.11
6	64611021	2	Rear Gas Legend Shock Absorber	\$ 244.03

SUSPENSION KITS

Kit Type	Part No.	Qty. per vehicle	Kit Description	List Price EACH
B	JEEPKIT002-B	1	RAISED	\$ 1,635.32
C	JEEPKIT002-C	1	RAISED HEAVY DUTY	\$ 1,644.19

Part No.	Load Rating	Description
All spring load ratings are an approximate only. Vehicle ride heights will vary depending on load and accessories fitted.		
CFR-104	0 to 100kg Constant Load	Suits Steel Bull Bar
CFR-104HD	100 to 150kg Constant Load	Suits Steel Bull Bar, Winch, Underbody Protection etc.
CRR-105	0 to 100kg Constant Load	
CRR-105HD	150 to 250kg Constant Load	

JEEP- Commander
XH Wagon
5/06 on
Coil/Coil

KIT COMPONENTS

Item	Part No.	Qty. per vehicle	Description	List Price EACH
1	CFR-108	2	Front Coil Springs- Raised (B)	\$ 126.26
2	CFR-108HD	2	Front Coil Springs- Raised Heavy Duty (C)	\$ 126.26
3	CRR-109	2	Rear Coil Springs- Raised (B)	\$ 126.26
4	CRR-109HD	2	Rear Coil Springs- Raised Heavy Duty (C)	\$ 126.26
5	64611020	2	Front Gas Legend Strut	\$ 321.11
6	64611021	2	Rear Gas Legend Shock Absorber	\$ 244.03

SUSPENSION KITS

Kit Type	Part No.	Qty. per vehicle	Kit Description	List Price EACH
B	JEEPKIT007-B	1	RAISED	\$ 1,635.32
C	JEEPKIT007-C	1	RAISED HEAVY DUTY	\$ 1,635.32

Part No.	Load Rating	Description
All spring load ratings are an approximate only. Vehicle ride heights will vary depending on load and accessories fitted.		
CFR-108	0 to 100kg Constant Load	Suits Steel Bull Bar
CFR-108HD	100 to 150kg Constant Load	Suits Steel Bull Bar, Winch, Underbody Protection etc.
CRR-109	0 to 100kg Constant Load	
CRR-109HD	150 to 250kg Constant Load	

JEEP- Wrangler
YJ All Models
1986-9/96
Leaf/Leaf

KIT COMPONENTS

Item	Part No.	Qty. per vehicle	Description	List Price EACH
1	AJ-14	2	Front Leaf Springs- Raised (B)	\$ 252.69
2	AJ-15	2	Rear Leaf Springs- Raised (B)	\$ 304.41
3	64611030	2	Front Gas Legend Shock Absorber	\$ 244.03
4	64611031	2	Rear Gas Legend Shock Absorber	\$ 244.03

SUSPENSION KITS

Kit Type	Part No.	Qty. per vehicle	Kit Description	List Price EACH
B	JEEPKIT006-B	1	RAISED	\$ 2,090.30

STEERING DAMPERS (Not included in Kit)

Item	Part No.	Qty. per vehicle	Description	List Price EACH
1B	5450001	1	Steering Damper Assembly- Heavy Duty	\$ 161.74
2B	5450001-RTC	1	Steering Damper Assembly- Return to Centre	\$ 202.68

Part No.	Load Rating	Description
All spring load ratings are an approximate only. Vehicle ride heights will vary depending on load and accessories fitted.		
AJ-14	0 to 100kg Constant Load	Suits Steel Bull Bar
AJ-15	0 to 100kg Constant Load	

JEEP- Wrangler
TJ All Models
10/96-2/07
Coil/Coil

KIT COMPONENTS

Item	Part No.	Qty. per vehicle	Description	List Price EACH
1	CFR-33	2	Front Coil Springs- Raised (B)	\$ 126.26
2	CRR-57	2	Rear Coil Springs- Raised (B)	\$ 126.26
3	64611026	2	Front Gas Legend Shock Absorber	\$ 244.03
4	64611027	2	Rear Gas Legend Shock Absorber	\$ 240.02

SUSPENSION KITS

Kit Type	Part No.	Qty. per vehicle	Kit Description	List Price EACH
B	JEEPKIT005-B	1	RAISED	\$ 1,473.14

ACCESSORIES (Not included in Kit)

Item	Part No.	Qty. per vehicle	Accessory Description	List Price EACH
1A	N51749	1	Front Urethane Bush Kit- Upper Radius Arm	\$ 248.99
2A	N51750	1	Front Urethane Bush Kit- Lower Radius Arm	\$ 324.31
3A	N82589	1	Front Urethane Bush Kit- Panhard- Front Eye	\$ 47.26
4A	N82590	1	Front Urethane Bush Kit- Panhard- Rear Eye	\$ 58.02
6A	N51749	1	Rear Urethane Bush Kit- Trailing Arm Lower	\$ 248.99
7A	N51750	1	Rear Urethane Bush Kit- Trailing Arm Upper	\$ 324.31

STEERING DAMPERS (Not included in Kit)

Item	Part No.	Qty. per vehicle	Description	List Price EACH
1B	5450001	1	Steering Damper Assembly- Heavy Duty	\$ 161.74
2B	5450001-RTC	1	Steering Damper Assembly- Return to Centre	\$ 202.68

Part No.	Load Rating	Description
All spring load ratings are an approximate only. Vehicle ride heights will vary depending on load and accessories fitted.		
CFR-33	0 to 100kg Constant Load	Suits Steel Bull Bar
CRR-57	0 to 100kg Constant Load	

JEEP- Wrangler
JK All Models
3/07 on
Coil/Coil

KIT COMPONENTS

Item	Part No.	Qty. per vehicle	Description	List Price EACH
1	CFR-101	2	Front Coil Springs- Raised (B)	\$ 126.26
2	CFR-101HD	2	Front Coil Springs- Raised Heavy Duty (C)	\$ 126.26
3	CRR-102	2	Rear Coil Springs- Raised (B)	\$ 126.26
4	CRR-102HD	2	Rear Coil Springs- Raised Heavy Duty (C)	\$ 126.26
5	64611022	2	Front Gas Legend Shock Absorber	\$ 244.03
6	64611023	2	Rear Gas Legend Shock Absorber	\$ 244.03

SUSPENSION KITS

Kit Type	Part No.	Qty. per vehicle	Kit Description	List Price EACH
B	JEEPKIT003-B	1	RAISED	\$ 1,481.14
C	JEEPKIT003-C	1	RAISED HEAVY DUTY	\$ 1,481.14

Part No.	Load Rating	Description
All spring load ratings are an approximate only. Vehicle ride heights will vary depending on load and accessories fitted.		
CFR-101	0 to 100kg Constant Load	Suits Steel Bull Bar
CFR-101HD	100 to 150kg Constant Load	Suits Steel Bull Bar, Winch, Underbody Protection etc.
CRR-102	0 to 100kg Constant Load	
CRR-102HD	150 to 250kg Constant Load	

LANDROVER- 90 Series
Wagon SWB
84 on
Coil/Coil

KIT COMPONENTS

Item	Part No.	Qty. per vehicle	Description	List Price EACH
1	RFR-26	2	Front Coil Springs- Raised (B)	\$ 126.26
2	RFR-26HD	2	Front Coil Springs- Raised Heavy Duty (C)	\$ 144.45
3	RRR-27	2	Rear Coil Springs- Raised (B)	\$ 126.26
4	RRR-27HD	2	Rear Coil Springs- Raised Heavy Duty (C)	\$ 144.45
5	64612541	2	Front Gas Legend Shock Absorber	\$ 244.03
6	64612542	2	Rear Gas Legend Shock Absorber	\$ 244.03

SUSPENSION KITS

Kit Type	Part No.	Qty. per vehicle	Kit Description	List Price EACH
B	LANDKIT001-B	1	RAISED	\$ 1,481.14
C	LANDKIT001-C	1	RAISED HEAVY DUTY	\$ 1,553.90

ACCESSORIES (Not included in Kit)

Item	Part No.	Qty. per vehicle	Accessory Description	List Price EACH
1A	N31649	1	Front Urethane Bush Kit- Shock Absorber Upper	\$ 89.11
2A	N31088	1	Front Urethane Bush Kit- Shock Absorber Lower	\$ 38.87
3A	N81650	1	Front Urethane Bush Kit- Radius Rod to Diff	\$ 197.39
4A	N81651	1	Front Urethane Bush Kit- Radius Rod to Chassis	\$ 86.94
5A	N81292	1	Front Urethane Bush Kit- Panhard Rod	\$ 59.05
6A	N31649	1	Rear Urethane Bush Kit- Shock Absorber Upper	\$ 89.11
7A	N31088	1	Rear Urethane Bush Kit- Shock Absorber Lower	\$ 38.87
8A	N81652	1	Rear Urethane Bush Kit- Upper Trailing Arm	\$ 85.91
9A	N81653	1	Rear Urethane Bush Kit- Low Trail Arm to Diff	\$ 90.79
10A	N81654	1	Rear Bush Kit- Low Trail Arm to Chassis 16mm ID	\$ 270.94
11A	N81655	1	Rear Bush Kit- Low Trail Arm to Chassis 20mm ID	\$ 270.94

Part No.	Load Rating	Description
All spring load ratings are an approximate only. Vehicle ride heights will vary depending on load and accessories fitted.		
RFR-26	0 to 100kg Constant Load	Suits Steel Bull Bar
RFR-26HD	100 to 150kg Constant Load	Suits Steel Bull Bar, Winch, Underbody Protection etc.
RRR-27	0 to 100kg Constant Load	
RRR-27HD	150 to 250kg Constant Load	

LANDROVER- 110 Series
County Wagon LWB (Petrol)
11/84-2/91
Coil/Coil



KIT COMPONENTS

Item	Part No.	Qty. per vehicle	Description	List Price EACH
1	RFR-11	2	Front Coil Springs- Raised (B)	\$ 144.58
2	RFR-11HD	2	Front Coil Springs- Raised Heavy Duty (C)	\$ 144.58
3	RRR-12	2	Rear Coil Springs- Raised (B)	\$ 146.08
4	RRR-12HD	2	Rear Coil Springs- Raised Heavy Duty (C)	\$ 146.08
5	64612541	2	Rear Gas Legend Shock Absorber	\$ 244.03
6	64612542	2	Rear Gas Legend Shock Absorber	\$ 244.03

SUSPENSION KITS

Kit Type	Part No.	Qty. per vehicle	Kit Description	List Price EACH
B	LANDKIT002-B	1	RAISED	\$ 1,557.42
C	LANDKIT002-C	1	RAISED HEAVY DUTY	\$ 1,557.42

ACCESSORIES (Not included in Kit)

Item	Part No.	Qty. per vehicle	Accessory Description	List Price EACH
1A	N31649	1	Front Urethane Bush Kit- Shock Absorber Upper	\$ 89.11
2A	N31088	1	Front Urethane Bush Kit- Shock Absorber Lower	\$ 38.87
3A	N81650	1	Front Urethane Bush Kit- Radius Rod to Diff	\$ 197.39
4A	N81651	1	Front Urethane Bush Kit- Radius Rod to Chassis	\$ 86.94
5A	N81292	1	Front Urethane Bush Kit- Panhard Rod	\$ 59.05
6A	N31649	1	Rear Urethane Bush Kit- Shock Absorber Upper	\$ 89.11
7A	N31088	1	Rear Urethane Bush Kit- Shock Absorber Lower	\$ 38.87
8A	N81652	1	Rear Urethane Bush Kit- Upper Trailing Arm	\$ 85.91
9A	N81653	1	Rear Urethane Bush Kit- Low Trail Arm to Diff	\$ 90.79
10A	N81654	1	Rear Bush Kit- Low Trail Arm to Chassis 16mm ID	\$ 270.94
11A	N81655	1	Rear Bush Kit- Low Trail Arm to Chassis 20mm ID	\$ 270.94

STEERING DAMPERS (Not included in Kit)

Item	Part No.	Qty. per vehicle	Description	List Price EACH
1B	5450005	1	Steering Damper Assembly- Heavy Duty	\$ 161.74
2B	5450005-RTC	1	Steering Damper Assembly- Return to Centre	\$ 202.68

Part No.	Load Rating	Description
All spring load ratings are an approximate only. Vehicle ride heights will vary depending on load and accessories fitted.		
RFR-11	0 to 100kg Constant Load	Suits Steel Bull Bar
RFR-11HD	100 to 150kg Constant Load	Suits Steel Bull Bar, Winch, Underbody Protection etc.
RRR-12	0 to 100kg Constant Load	
RRR-12HD	150 to 250kg Constant Load	

LANDROVER- 110 Series
County Wagon LWB (Diesel)
11/84-2/91
Coil/Coil



KIT COMPONENTS

Item	Part No.	Qty. per vehicle	Description	List Price EACH
1	RFR-13	2	Front Coil Springs- Raised (B)	\$ 143.61
2	RFR-13HD	2	Front Coil Springs- Raised Heavy Duty (C)	\$ 161.27
3	RRR-12	2	Rear Coil Springs- Raised (B)	\$ 146.08
4	RRR-12HD	2	Rear Coil Springs- Raised Heavy Duty (C)	\$ 146.08
5	64612541	2	Rear Gas Legend Shock Absorber	\$ 244.03
6	64612542	2	Rear Gas Legend Shock Absorber	\$ 244.03

SUSPENSION KITS

Kit Type	Part No.	Qty. per vehicle	Kit Description	List Price EACH
B	LANDKIT003-B	1	RAISED	\$ 1,555.48
C	LANDKIT003-C	1	RAISED HEAVY DUTY	\$ 1,590.80

ACCESSORIES (Not included in Kit)

Item	Part No.	Qty. per vehicle	Accessory Description	List Price EACH
1A	N31649	1	Front Urethane Bush Kit- Shock Absorber Upper	\$ 89.11
2A	N31088	1	Front Urethane Bush Kit- Shock Absorber Lower	\$ 38.87
3A	N81650	1	Front Urethane Bush Kit- Radius Rod to Diff	\$ 197.39
4A	N81651	1	Front Urethane Bush Kit- Radius Rod to Chassis	\$ 86.94
5A	N81292	1	Front Urethane Bush Kit- Panhard Rod	\$ 59.05
6A	N31649	1	Rear Urethane Bush Kit- Shock Absorber Upper	\$ 89.11
7A	N31088	1	Rear Urethane Bush Kit- Shock Absorber Lower	\$ 38.87
8A	N81652	1	Rear Urethane Bush Kit- Upper Trailing Arm	\$ 85.91
9A	N81653	1	Rear Urethane Bush Kit- Low Trail Arm to Diff	\$ 90.79
10A	N81654	1	Rear Bush Kit- Low Trail Arm to Chassis 16mm ID	\$ 270.94
11A	N81655	1	Rear Bush Kit- Low Trail Arm to Chassis 20mm ID	\$ 270.94

STEERING DAMPERS (Not included in Kit)

Item	Part No.	Qty. per vehicle	Description	List Price EACH
1B	5450005	1	Steering Damper Assembly- Heavy Duty	\$ 161.74
2B	5450005-RTC	1	Steering Damper Assembly- Return to Centre	\$ 202.68

Part No.	Load Rating	Description
All spring load ratings are an approximate only. Vehicle ride heights will vary depending on load and accessories fitted.		
RFR-13	0 to 100kg Constant Load	Suits Steel Bull Bar
RFR-13HD	100 to 150kg Constant Load	Suits Steel Bull Bar, Winch, Underbody Protection etc.
RRR-12	0 to 100kg Constant Load	
RRR-12HD	150 to 250kg Constant Load	

LANDROVER- 110 Series Defender
Wagon and Tray Back LWB (Diesel)
3/92 on
Coil/Coil



KIT COMPONENTS

Item	Part No.	Qty. per vehicle	Description	List Price EACH
1	RFR-20	2	Front Coil Springs- Raised (B)	\$ 126.26
2	RFR-20HD	2	Front Coil Springs- Raised Heavy Duty (C)	\$ 136.19
3	RRR-22	2	Rear Coil Springs- Raised (B)	\$ 211.30
4	RRR-22HD	2	Rear Coil Springs- Raised Heavy Duty (C)	\$ 244.67
5	64612541	2	Front Gas Legend Shock Absorber	\$ 244.03
6	64612542	2	Rear Gas Legend Shock Absorber	\$ 244.03

SUSPENSION KITS

Kit Type	Part No.	Qty. per vehicle	Kit Description	List Price EACH
B	LANDKIT004-B	1	RAISED	\$ 1,651.23
C	LANDKIT004-C	1	RAISED HEAVY DUTY	\$ 1,737.83

ACCESSORIES (Not included in Kit)

Item	Part No.	Qty. per vehicle	Accessory Description	List Price EACH
1A	N31649	1	Front Urethane Bush Kit- Shock Absorber Upper	\$ 89.11
2A	N31088	1	Front Urethane Bush Kit- Shock Absorber Lower	\$ 38.87
3A	N81650	1	Front Urethane Bush Kit- Radius Rod to Diff	\$ 197.39
4A	N81651	1	Front Urethane Bush Kit- Radius Rod to Chassis	\$ 86.94
5A	N81292	1	Front Urethane Bush Kit- Panhard Rod	\$ 59.05
6A	N31088	1	Rear Urethane Bush Kit- Shock Absorber Lower	\$ 38.87
7A	N81652	1	Rear Urethane Bush Kit- Upper Trailing Arm	\$ 85.91
8A	N81653	1	Rear Urethane Bush Kit- Low Trail Arm to Diff	\$ 90.79
9A	N81655	1	Rear Bush Kit- Low Trail Arm to Chassis 20mm ID	\$ 270.94

STEERING DAMPERS (Not included in Kit)

Item	Part No.	Qty. per vehicle	Description	List Price EACH
1B	5450005	1	Steering Damper Assembly- Heavy Duty	\$ 161.74
2B	5450005-RTC	1	Steering Damper Assembly- Return to Centre	\$ 202.68

Part No.	Load Rating	Description
All spring load ratings are an approximate only. Vehicle ride heights will vary depending on load and accessories fitted.		
RFR-20	0 to 100kg Constant Load	Suits Steel Bull Bar
RFR-20HD	100 to 150kg Constant Load	Suits Steel Bull Bar, Winch, Underbody Protection etc.
RRR-22	0 to 100kg Constant Load	
RRR-22HD	150 to 250kg Constant Load	

LANDROVER- 130 Series
Crew Cab Tray Back LWB (Diesel)
11/94-1/99
Coil/Coil

KIT COMPONENTS

Item	Part No.	Qty. per vehicle	Description	List Price EACH
1	RFR-20	2	Front Coil Springs- Raised (B)	\$ 126.26
2	RFR-20HD	2	Front Coil Springs- Raised Heavy Duty (C)	\$ 136.19
3	RRR-22	2	Rear Coil Springs- Raised (B)	\$ 211.30
4	RRR-22HD	2	Rear Coil Springs- Raised Heavy Duty (C)	\$ 244.67
5	64612541	2	Front Gas Legend Shock Absorber	\$ 244.03
6	64612542	2	Rear Gas Legend Shock Absorber	\$ 244.03

Note: Alternative Extra Long Travel Rear Gas Legend Shock Absorber P/N 6462542L (\$198.00 each)

SUSPENSION KITS

Kit Type	Part No.	Qty. per vehicle	Kit Description	List Price EACH
B	LANDKIT005-B	1	RAISED	\$ 1,651.23
C	LANDKIT005-C	1	RAISED HEAVY DUTY	\$ 1,737.83

Highlighted Part Number: Lovells strongly recommend fitting this Part Number when using Raised Heavy Duty coil springs.

ACCESSORIES (Not included in Kit)

Item	Part No.	Qty. per vehicle	Accessory Description	List Price EACH
1A	N31649	1	Front Urethane Bush Kit- Shock Absorber Upper	\$ 89.11
2A	N31088	1	Front Urethane Bush Kit- Shock Absorber Lower	\$ 38.87
3A	N81650	1	Front Urethane Bush Kit- Radius Rod to Diff	\$ 197.39
4A	N81651	1	Front Urethane Bush Kit- Radius Rod to Chassis	\$ 86.94
5A	N81292	1	Front Urethane Bush Kit- Panhard Rod	\$ 59.05
6A	N31088	1	Rear Urethane Bush Kit- Shock Absorber Lower	\$ 38.87
7A	N81652	1	Rear Urethane Bush Kit- Upper Trailing Arm	\$ 85.91
8A	N81653	1	Rear Urethane Bush Kit- Low Trail Arm to Diff	\$ 90.79
9A	N81655	1	Rear Bush Kit- Low Trail Arm to Chassis 20mm ID	\$ 270.94

STEERING DAMPERS (Not included in Kit)

Item	Part No.	Qty. per vehicle	Description	List Price EACH
1B	5450005	1	Steering Damper Assembly- Heavy Duty	\$ 161.74
2B	5450005-RTC	1	Steering Damper Assembly- Return to Centre	\$ 202.68

Part No.	Load Rating	Description
All spring load ratings are an approximate only. Vehicle ride heights will vary depending on load and accessories fitted.		
RFR-20	0 to 100kg Constant Load	Suits Steel Bull Bar
RFR-20HD	100 to 150kg Constant Load	Suits Steel Bull Bar, Winch, Underbody Protection etc.
RRR-22	0 to 100kg Constant Load	
RRR-22HD	150 to 250kg Constant Load	

LANDROVER- 110 Series
Td5 Wagon LWB (Diesel)
2/99 on
Coil/Coil

KIT COMPONENTS

Item	Part No.	Qty. per vehicle	Description	List Price EACH
1	RFR-14	2	Front Coil Springs- Raised (B)	\$ 126.26
2	RFR-13	2	Front Coil Springs- Raised Heavy Duty (C)	\$ 143.61
3	RRR-22	2	Rear Coil Springs- Raised (B)	\$ 211.30
4	RRR-22HD	2	Rear Coil Springs- Raised Heavy Duty (C)	\$ 244.67
5	64612541	2	Front Gas Legend Shock Absorber	\$ 244.03
6	64612542	2	Rear Gas Legend Shock Absorber	\$ 244.03

SUSPENSION KITS

Kit Type	Part No.	Qty. per vehicle	Kit Description	List Price EACH
B	LANDKIT006-B	1	RAISED	\$ 1,651.23
C	LANDKIT006-C	1	RAISED HEAVY DUTY	\$ 1,752.66

STEERING DAMPERS (Not included in Kit)

Item	Part No.	Qty. per vehicle	Description	List Price EACH
1B	5450005	1	Steering Damper Assembly- Heavy Duty	\$ 161.74
2B	5450005-RTC	1	Steering Damper Assembly- Return to Centre	\$ 202.68

Part No.	Load Rating	Description
All spring load ratings are an approximate only. Vehicle ride heights will vary depending on load and accessories fitted.		
RFR-14	0 to 100kg Constant Load	Suits Steel Bull Bar
RFR-13	100 to 150kg Constant Load	Suits Steel Bull Bar, Winch, Underbody Protection etc.
RRR-22	0 to 100kg Constant Load	
RRR-22HD	150 to 250kg Constant Load	

LANDROVER- Discovery
JG Wagon
4/91-3/99
Coil/Coil

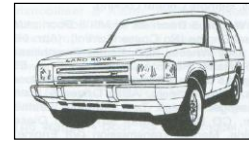

KIT COMPONENTS

Item	Part No.	Qty. per vehicle	Description	List Price EACH
1	RFR-1	2	Front Coil Springs- Standard Height (A)	\$ 126.26
2	RFR-5	2	Front Coil Springs- Raised (B)	\$ 126.26
3	RFR-20	2	Front Coil Springs- Raised Heavy Duty (C)	\$ 126.26
4	RRS-18	2	Rear Coil Springs- Standard Height (A)	\$ 132.04
5	RRR-18	2	Rear Coil Springs- Raised (B)	\$ 146.08
6	RRR-24	2	Rear Coil Springs- Raised Heavy Duty (C)	\$ 139.69
7	64612541	2	Front Gas Legend Shock Absorber	\$ 244.03
8	64612542	2	Rear Gas Legend Shock Absorber	\$ 244.03

SUSPENSION KITS

Kit Type	Part No.	Qty. per vehicle	Kit Description	List Price EACH
A	LANDKIT007-A	1	STANDARD HEIGHT	\$ 1,492.70
B	LANDKIT007-B	1	RAISED	\$ 1,520.78
C	LANDKIT007-C	1	RAISED HEAVY DUTY	\$ 1,508.00

ACCESSORIES (Not included in Kit)

Item	Part No.	Qty. per vehicle	Accessory Description	List Price EACH
1A	N81651	1	Front Urethane Bush Kit- Radius Rod to Chassis	\$ 86.94
2A	N81292	1	Front Urethane Bush Kit- Panhard Rod	\$ 59.05
3A	N31088	1	Rear Urethane Bush Kit- Shock Absorber Upper	\$ 38.87
4A	N31102	1	Rear Urethane Bush Kit- Shock Absorber Lower	\$ 46.80
5A	N81652	1	Rear Urethane Bush Kit- Upper Trailing Arm	\$ 85.91
6A	N81653	1	Rear Urethane Bush Kit- Low Trail Arm to Diff	\$ 90.79
7A	N81654	1	Rear Bush Kit- Low Trail Arm to Chassis 16mm ID	\$ 270.94
8A	N81655	1	Rear Bush Kit- Low Trail Arm to Chassis 20mm ID	\$ 270.94

STEERING DAMPERS (Not included in Kit)

Item	Part No.	Qty. per vehicle	Description	List Price EACH
1B	5450004	1	Steering Damper Assembly- Heavy Duty	\$ 161.74
2B	5450004-RTC	1	Steering Damper Assembly- Return to Centre	\$ 202.68

Part No.	Load Rating	Description
All spring load ratings are an approximate only. Vehicle ride heights will vary depending on load and accessories fitted.		
RFR-1	0 to 100kg Constant Load	Suits Steel Bull Bar
RFR-5	0 to 100kg Constant Load	Suits Steel Bull Bar
RFR-20	100 to 150kg Constant Load	Suits Steel Bull Bar, Winch, Underbody Protection etc.
RRS-18	0 to 100kg Constant Load	
RRR-18	0 to 100kg Constant Load	
RRR-24	100 to 150kg Constant Load	

LANDROVER- Discovery
TG Wagon (Series II)
3/99-2/05
Coil/Coil



KIT COMPONENTS

Item	Part No.	Qty. per vehicle	Description	List Price EACH
1	RFS-32	2	Front Coil Springs- Standard Height (A)	\$ 126.26
2	RFR-32	2	Front Coil Springs- Raised (B)	\$ 126.26
3	RFR-32HD	2	Front Coil Springs- Raised Heavy Duty (C)	\$ 126.26
4	RRR-4	2	Rear Coil Springs- Standard Height (A)	\$ 126.26
5	RRR-8	2	Rear Coil Springs- Raised (B)	\$ 126.26
6	RRR-8HD	2	Rear Coil Springs- Raised Heavy Duty (C)	\$ 144.45
7	64612214	2	Front Gas Legend Shock Absorber	\$ 244.03
8	64612215	2	Rear Gas Legend Shock Absorber	\$ 244.03

SUSPENSION KITS

Kit Type	Part No.	Qty. per vehicle	Kit Description	List Price EACH
A	LANDKIT008-A	1	STANDARD HEIGHT	\$ 1,481.14
B	LANDKIT008-B	1	RAISED	\$ 1,481.14
C	LANDKIT008-C	1	RAISED HEAVY DUTY	\$ 1,517.52

STEERING DAMPERS (Not included in Kit)

Item	Part No.	Qty. per vehicle	Description	List Price EACH
1B	5450003	1	Steering Damper Assembly- Heavy Duty	\$ 161.74

Part No.	Load Rating	Description
All spring load ratings are an approximate only. Vehicle ride heights will vary depending on load and accessories fitted.		
RFS-32	0 to 100kg Constant Load	Suits Steel Bull Bar
RFR-32	0 to 100kg Constant Load	Suits Steel Bull Bar
RFR-32HD	100 to 150kg Constant Load	Suits Steel Bull Bar, Winch, Underbody Protection etc.
RRR-4	0 to 100kg Constant Load	
RRR-8	0 to 100kg Constant Load	
RRR-8HD	150 to 250kg Constant Load	

LANDROVER- Discovery
Series III
3/05 on
Coil/Coil

KIT COMPONENTS

Item	Part No.	Qty. per vehicle	Description	List Price EACH
1	RFR-40	2	Front Coil Springs- Raised	\$ 126.26
2	RRR-41	2	Rear Coil Springs- Raised	\$ 136.74
3	64611003	2	Front Gas Legend Shock Absorber	\$ 321.11

Part No.	Load Rating	Description
All spring load ratings are an approximate only. Vehicle ride heights will vary depending on load and accessories fitted.		
RFR-40	0 to 100kg Constant Load	Suits Steel Bull Bar
RRR-41	0 to 100kg Constant Load	

LANDROVER- Range Rover
Wagon
9/72-4/95
Coil/Coil

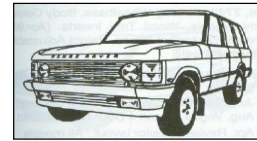

KIT COMPONENTS

Item	Part No.	Qty. per vehicle	Description	List Price EACH
1	RFR-1	2	Front Coil Springs- Standard Height (A)	\$ 126.26
2	RFR-5	2	Front Coil Springs- Raised (B)	\$ 126.26
3	RFR-7	2	Front Coil Springs- Raised Heavy Duty (C)	\$ 126.26
4	RRR-2	2	Rear Coil Springs- Standard Height (A)	\$ 126.26
5	RRR-6	2	Rear Coil Springs- Raised (B)	\$ 126.26
6	RRR-8	2	Rear Coil Springs- Raised Heavy Duty (C)	\$ 126.26
7	64612541	2	Front Gas Legend Shock Absorber	\$ 244.03
8	64612542	2	Rear Gas Legend Shock Absorber	\$ 244.03

SUSPENSION KITS

Kit Type	Part No.	Qty. per vehicle	Kit Description	List Price EACH
A	ROVKIT001-A	1	STANDARD HEIGHT	\$ 1,481.14
B	ROVKIT001-B	1	RAISED	\$ 1,481.14
C	ROVKIT001-C	1	RAISED HEAVY DUTY	\$ 1,481.14

STEERING DAMPERS (Not included in Kit)

Item	Part No.	Qty. per vehicle	Description	List Price EACH
1B	5450004	1	Steering Damper Assembly- Heavy Duty	\$ 161.74
2B	5450004-RTC	1	Steering Damper Assembly- Return to Centre	\$ 202.68

Part No.	Load Rating	Description
All spring load ratings are an approximate only. Vehicle ride heights will vary depending on load and accessories fitted.		
RFR-1	0 to 100kg Constant Load	Suits Steel Bull Bar
RFR-5	0 to 100kg Constant Load	Suits Steel Bull Bar
RFR-7	100 to 150kg Constant Load	Suits Steel Bull Bar, Winch, Underbody Protection etc.
RRR-2	0 to 100kg Constant Load	
RRR-6	0 to 100kg Constant Load	
RRR-8	100 to 150kg Constant Load	

MAZDA- B2600- Bravo
Pick Up and Tray Back
3/88-10/02
Torsion Bar/Leaf

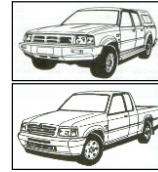

KIT COMPONENTS

Item	Part No.	Qty. per vehicle	Description	List Price EACH
1	MAZDA005	1 Pair	Front Heavy Duty Torsion Bars	\$ 530.35
2	MR-26SH	2	Rear Leaf Springs- Standard Height (A)	\$ 606.93
3	MR-26	2	Rear Leaf Springs- Raised (B)	\$ 615.05
4	MR-26HD	2	Rear Leaf Springs- Raised Heavy Duty (C)	\$ 644.33
5	N72065	1	Rear Urethane Bush Kit- Spring Front eye	\$ 88.74
6	N71136	1	Rear Urethane Bush Kit- Spring Rear eye	\$ 47.33
7	N71215	1	Rear Urethane Bush Kit- Shackle	\$ 60.24
8	UBL-18	4	Rear U-Bolts	\$ 24.61
9	LGSKMAZ-001	2	Rear Greasable Shackle Kit	\$ 53.93
10	LGPKFD-004	2	Rear Greasable Pin Kit	\$ 66.88
11	6462543P	2	Front Gas Legend Shock Absorber	\$ 244.03
12	6462525T	2	Rear Gas Legend Shock Absorber	\$ 268.60

SUSPENSION KITS

Kit Type	Part No.	Qty. per vehicle	Kit Description	List Price EACH
A	MAZKIT001-A	1	STANDARD HEIGHT	\$ 3,305.83
B	MAZKIT001-B	1	RAISED	\$ 3,322.07
C	MAZKIT001-C	1	RAISED HEAVY DUTY	\$ 3,380.63

ACCESSORIES (Not included in Kit)

Item	Part No.	Qty. per vehicle	Accessory Description	List Price EACH
1A	N11421	1	Front Urethane Bush Kit- Steering Idler Bush	\$ 35.89
2A	N31207	1	Front Urethane Bush Kit- Sway Bar Link	\$ 52.86
3A	N21058	1	Front Urethane Bush Kit- Sway Bar Mount	\$ 30.34
4A	N21172	1	Front Urethane Bush Kit- Shock Absorber Upper	\$ 31.65

Part No.	Load Rating	Description
All spring load ratings are an approximate only. Vehicle ride heights will vary depending on load and accessories fitted.		
MR-26SH	0 to 100kg Constant Load	
MR-26	0 to 100kg Constant Load	
MR-26HD	150 to 250kg Constant Load	

MAZDA- B2600- Bravo

Pick Up and Tray Back

11/02-10/06

Torsion Bar/Leaf



KIT COMPONENTS

Item	Part No.	Qty. per vehicle	Description	List Price EACH
1	MAZDA001	1 Pair	Front Heavy Duty Torsion Bars	\$ 626.18
2	MR-26SH	2	Rear Leaf Springs- Raised (B)	\$ 606.93
3	MR-26	2	Rear Leaf Springs- Raised Heavy Duty (C)	\$ 615.05
4	N72065	1	Rear Urethane Bush Kit- Spring Front eye	\$ 88.74
5	N71136	1	Rear Urethane Bush Kit- Spring Rear eye	\$ 47.33
6	N71215	1	Rear Urethane Bush Kit- Shackle	\$ 60.24
7	UBL-18	4	Rear U-Bolts	\$ 24.61
8	LGSKMAZ-001	2	Rear Greasable Shackle Kit	\$ 53.93
9	LGPKFD-004	2	Rear Greasable Pin Kit	\$ 66.88
10	6462543P	2	Front Gas Legend Shock Absorber	\$ 244.03
11	6462525T	2	Rear Gas Legend Shock Absorber	\$ 268.60

SUSPENSION KITS

Kit Type	Part No.	Qty. per vehicle	Kit Description	List Price EACH
B	MAZKIT002-B	1	RAISED	\$ 3,401.65
C	MAZKIT002-C	1	RAISED HEAVY DUTY	\$ 3,417.89

ACCESSORIES (Not included in Kit)

Item	Part No.	Qty. per vehicle	Accessory Description	List Price EACH
1A	N11421	1	Front Urethane Bush Kit- Steering Idler Bush	\$ 35.89
2A	N31207	1	Front Urethane Bush Kit- Sway Bar Link	\$ 52.86
3A	N21058	1	Front Urethane Bush Kit- Sway Bar Mount	\$ 30.34
4A	N21172	1	Front Urethane Bush Kit- Shock Absorber Upper	\$ 31.65

Part No.	Load Rating	Description
All spring load ratings are an approximate only. Vehicle ride heights will vary depending on load and accessories fitted.		
MR-26SH	0 to 100kg Constant Load	
MR-26	0 to 100kg Constant Load	

MAZDA- BT50
Pick Up and Tray Back
11/06-12/11
Torsion Bar/Leaf

KIT COMPONENTS

Item	Part No.	Qty. per vehicle	Description	List Price EACH
1	MAZDA003	1 Pair	Front Heavy Duty Torsion Bars	\$ 660.33
2	MR-28	2	Rear Leaf Springs- Raised (B)	\$ 652.27
3	MR-28HD	2	Rear Leaf Springs- Raised Heavy Duty (C)	\$ 794.39
4	N73383	1	Rear Urethane Bush Kit- Spring Front eye	\$ 63.53
5	N71136	1	Rear Urethane Bush Kit- Spring Rear eye	\$ 47.33
6	N71215	1	Rear Urethane Bush Kit- Shackle	\$ 60.24
7	UBL-50	4	Rear U-Bolts	\$ 24.61
8	LGSKMAZ-001	2	Rear Greasable Shackle Kit	\$ 53.93
9	LGPK387-2	2	Rear Greasable Pin Kit	\$ 47.08
10	6462543P	2	Front Gas Legend Shock Absorber	\$ 244.03
11	6462525T	2	Rear Gas Legend Shock Absorber	\$ 268.60

SUSPENSION KITS

Kit Type	Part No.	Qty. per vehicle	Kit Description	List Price EACH
B	MAZKIT003-B	1	RAISED	\$ 3,461.68
C	MAZKIT003-C	1	RAISED HEAVY DUTY	\$ 3,745.92

ACCESSORIES (Not included in Kit)

Item	Part No.	Qty. per vehicle	Accessory Description	List Price EACH
1A	N11421	1	Front Urethane Bush Kit- Steering Idler Bush	\$ 35.89
2A	N31207	1	Front Urethane Bush Kit- Sway Bar Link	\$ 52.86
3A	N21058	1	Front Urethane Bush Kit- Sway Bar Mount	\$ 30.34
4A	N21172	1	Front Urethane Bush Kit- Shock Absorber Upper	\$ 31.65

Part No.	Load Rating	Description
All spring load ratings are an approximate only. Vehicle ride heights will vary depending on load and accessories fitted.		
MR-28	0 to 100kg Constant Load	
MR-28HD	150 to 250kg Constant Load	

Mazda- BT50
MY12 Pick Up and Tray Back
01/12-6/2020
Coil/Leaf

KIT COMPONENTS

Item	Part No.	Qty. per vehicle	Description	List Price EACH
1	FFS-90	2	Front Coil Springs- Standard Height (A)	\$ 126.26
2	FFR-90	2	Front Coil Springs- Raised (B)	\$ 126.26
3	FFR-90HD	2	Front Coil Springs- Raised Heavy Duty (C)	\$ 126.26
4	FR-1SH	2	Rear Leaf Springs- Standard (A)	\$ 616.26
5	FR-1	2	Rear Leaf Springs- Raised (B)	\$ 616.29
6	FR-1HD	2	Rear Leaf Springs- Raised Heavy Duty (C)	\$ 795.39
7	FR-1XHD	2	Rear Leaf Springs- Raised Heavy Duty (D)	\$ 937.13
8	N73395	1	Rear Urethane Bush Kit- Spring Rear eyes	\$ 43.44
9	N73396	1	Rear Urethane Bush Kit- Shackle Bush Kit	\$ 51.60
10	N73394	1	Rear Urethane Bush Kit- Spring Front eyes	\$ 114.52
11	UBL-39	4	Rear U-Bolts	\$ 24.61
12	LGSK390	2	Rear Greasable Shackle Kit	\$ 96.30
13	LGPK387-2	2	Rear Greasable Pin Kit	\$ 47.08
14	64611037	2	Front Gas Legend Strut	\$ 331.67
15	6462525T	2	Rear Gas Legend Shock Absorber	\$ 268.60

SUSPENSION KITS

Kit Type	Part No.	Qty. per vehicle	Kit Description	List Price EACH
A	FORDKIT008-A	1	STANDARD	\$ 3,280.35
B	FORDKIT008-B	1	RAISED	\$ 3,280.40
C	FORDKIT008-C	1	RAISED HEAVY DUTY	\$ 3,638.60
D	FORDKIT008-D	1	RAISED EXTRA HEAVY DUTY	\$ 3,922.08

Optional parts

Item	Part No.	Qty. per vehicle	Option Description	List Price EACH
1A	LOVUCA-GEN2	1	Lovells Extreme Upper Control Arm kit	\$ 920.00
2A	LPWR56509	1	Lovells Radiator Closemesh (3.2 Litre)	\$ 2,363.78
3A	LPWI53860	1	Lovells Intercooler (3.2 Litre)	\$ 1,932.30

ACCESSORIES (Not included in Kit)

Item	Part No.	Qty. per vehicle	Accessory Description	List Price EACH
1A	TSTMAZ-001	1	Drive Shaft Spacer Kit	\$ 94.15

Highlighted Accessories: Lovells strongly recommend fitting these accessories when using Raised OR Raised Heavy Duty springs.

Note: When fitting raised rear springs to this vehicle, driveline vibration can occur. Lovells recommend using the above drive shaft spacer kit.

Part No.	Load Rating	Description
All spring load ratings are an approximate only. Vehicle ride heights will vary depending on load and accessories fitted.		
FFS-90	0 to 100kg Constant Load	Suits Steel Bull Bar
FFR-90	0 to 100kg Constant Load	Suits Steel Bull Bar
FFR-90HD	100 to 150kg Constant Load	Suits Steel Bull Bar, Winch, Underbody Protection etc.
FR-1SH	0 to 100kg Constant Load	
FR-1	0 to 100kg Constant Load	
FR-1HD	150 to 250kg Constant Load	
FR-1XHD	400 to 500kg Constant Load	

Mazda- BT50
MY12 Pick Up and Tray Back
01/12-6/2020
Coil/Leaf

3500KG GVM Upgrade Kit (Fitted Price)-State Compliance

KIT COMPONENTS

Item	Part No.	Qty. per vehicle	Description	SOLD AS KIT ONLY
1	FFS-90	2	Front Coil Springs- Standard Height	
2	FR-1XHD	2	Rear Leaf Springs- Raised Heavy Duty	
3	N73395	1	Rear Urethane Bush Kit- Spring Rear eyes	
4	N73396	1	Rear Urethane Bush Kit- Shackle Bush Kit	
5	N73394	1	Rear Urethane Bush Kit- Spring Front eyes	
6	UBL-39	4	Rear U-Bolts	
7	LGSK390	2	Rear Greasable Shackle Kit	
8	LGPK387-2	2	Rear Greasable Pin Kit	
9	64611037	2	Front Gas Legend Strut	
10	6462525T	2	Rear Gas Legend Shock Absorber	
11		1	3500kg Compliance Plate	
12		1	Re-Tension U-Bolts Warning (Decal)	
13		2	Lovells Mudflaps	
13		1	3500kg Tyre Loading Placard (Decal)	
14		1	Owners Manual	
15		1	GVM Upgrade Fitting Instructions	

SUSPENSION KITS

Kit Type	Part No.	Qty. per vehicle	Kit Description	Retail Price
GVM	FORDKIT009-GVM	1	GVM Upgrade Kit (Fitted Price)	\$ 5,200.00

NOTE: Fitted Price plus GST

Optional parts

Item	Part No.	Qty. per vehicle	Option Description	List Price EACH
1A	LOVUCA-GEN2	1	Lovells Extreme Upper Control Arm kit	\$ 920.00
2A	LPWR56509	1	Lovells Radiator Closemesh (3.2 Litre)	\$ 2,363.78
3A	LPWI53860	1	Lovells Intercooler (3.2 Litre)	\$ 1,932.30

ACCESSORIES (Not included in Kit)

Item	Part No.	Qty. per vehicle	Accessory Description	List Price EACH
1A	T SMAZ-001	1	Drive Shaft Spacer Kit	\$ 94.15

Part No.	Load Rating	Description
All spring load ratings are an approximate only. Vehicle ride heights will vary depending on load and accessories fitted.		
FFS-90	0 to 100kg Constant Load	Suits Steel Bull Bar
FR-1XHD	400 to 500kg Constant Load	To GVM

*****NOTE:** The above GVM Upgrade Kit for Federal Compliance under Second Stage Manufacturer Approval, with a Federal compliance plate, is no longer available
 The above kit can still be supplied under State Compliance and will require inspection, by a Lovells endorsed signatory and /or Production Facility.
 Consult your nearest Lovells Production facility for Individual State requirements.

Mazda- BT50

MY21 Pick Up and Tray Back

07/2020 On

Coil/Leaf

KIT COMPONENTS

Item	Part No.	Qty. per vehicle	Description	List Price EACH
1	IFS-002	2	Front Coil Springs- Standard Height (A)	\$ 126.26
2	IFR-002	2	Front Coil Springs- Raised (B)	\$ 126.26
3	IFR-002HD	2	Front Coil Springs- Raised Heavy Duty (C & D)	\$ 126.26
4	IS-003SH	2	Rear Leaf Springs- Standard (A)	\$ 677.23
5	IS-003	2	Rear Leaf Springs- Raised (B)	\$ 639.99
6	IS-003HD	2	Rear Leaf Springs- Raised Heavy Duty (C)	\$ 799.99
7	IS-003EHD	2	Rear Leaf Springs- Raised Extra Heavy Duty (D)	\$ 914.27
8	N73254	1	Rear Urethane Bush Kit- Spring Front Eyes	\$ 83.71
9	N73474	1	Rear Urethane Bush Kit- Rear Top Shackle	\$ 59.66
10	N71021	1	Rear Urethane Bush Kit- Rear Spring Eye	\$ 42.23
11	UBL-06	4	Rear U-Bolts	\$ 24.61
12	LGSK393	2	Rear Greasable Shackle Kit	\$ 74.63
13	LGPK387-2	2	Rear Pin Kit (Non Greasable)	\$ 47.08
14	64611038	2	Front Gas Legend Strut	\$ 329.07
15	6462258B	2	Rear Gas Legend Shock Absorber	\$ 269.38
16	64611038LH-2.0ADJMONO	1	Front 2.0" Mono Tube Strut with Remote Reservoir (Platinum)	\$ 720.65
17	64611038RH-2.0ADJMONO	1	Front 2.0" Mono Tube Strut with Remote Reservoir (Platinum)	\$ 720.65
18	6462258B-2.0ADJMONO	2	Rear 2.0" Mono Tube Strut with Remote Reservoir (Platinum)	\$ 678.59

SUSPENSION KITS

Kit Type	Part No.	Qty. per vehicle	Kit Description	List Price EACH
A	ISUZKIT005-A	1	STANDARD	\$ 3,289.12
B	ISUZKIT005-B	1	RAISED	\$ 3,214.64
C	ISUZKIT005-C	1	RAISED HEAVY DUTY	\$ 3,534.64
D	ISUZKIT005-D	1	RAISED EXTRA HEAVY DUTY	\$ 3,805.43
A Platinum	ISUZKIT005-A PLAT	1	STANDARD	\$ 4,932.92
B Platinum	ISUZKIT005-B-PLAT	1	RAISED	\$ 4,858.45
C Platinum	ISUZKIT005-C-PLAT	1	RAISED HEAVY DUTY	\$ 5,178.44
D Platinum	ISUZKIT005-D-PLAT	1	RAISED EXTRA HEAVY DUTY	\$ 5,407.01

Optional parts

Item	Part No.	Qty. per vehicle	Option Description	List Price EACH
1A	LOVUCA-D/MAX	1	Lovells Extreme Upper Control Arm kit	\$ 995.00
2A	LPWR110402	1	Lovells Radiator Closemesh	\$ 2,600.00

ACCESSORIES (Not included in Kit)

Item	Part No.	Qty. per vehicle	Accessory Description	List Price EACH
1A	BLEB001	1	Brake Line Extension Bracket	\$ 31.51

Part No.	Load Rating	Description
All spring load ratings are an approximate only. Vehicle ride heights will vary depending on load and accessories fitted.		
IFS-002	0 to 100kg Constant Load	Suits Steel Bull Bar
IFR-002	0 to 100kg Constant Load	Suits Steel Bull Bar
IFR-002HD	100 to 150kg Constant Load	Suits Steel Bull Bar, Winch, Underbody Protection etc.
IS-003SH	0 to 100kg Constant Load	
IS-003	0 to 100kg Constant Load	
IS-003HD	150 to 250kg Constant Load	
IS-003EHD	400 to 500kg Constant Load	

Mazda- BT50
MY21 Pick Up and Tray Back
07/2020 On
Coil/Leaf

3600KG GVM Upgrade Kit (Fitted Price)-Federal Compliance

KIT COMPONENTS

Item	Part No.	Qty. per vehicle	Description	SOLD AS KIT ONLY
1	IFS-002	2	HD Front Coil Springs- Standard Height (Option 1) Vehicles with minimal load bearing front accessories. Axle Capacities under 1300kg	
2	IFR-002	2	HD Front Coil Springs- Raised (Option 2) Vehicles with load bearing accessories, i.e. Steel Bull bar, Winch, Dual Batteries	
3	IS-003EHD	2	Rear Leaf Springs- Raised Extra Heavy Duty	
4	N73254	1	Rear Urethane Bush Kit- Spring Front Eyes	
5	N73474	1	Rear Urethane Bush Kit- Rear Top Shackle	
6	N71021	1	Rear Urethane Bush Kit- Rear Spring Eye	
7	UBL-06	4	Rear U-Bolts	
8	LGSK393	2	Rear Greasable Shackle Kit	
9	LGPK387-2	2	Rear Pin Kit (Non Greasable)	
10	64611038	2	Front Gas Legend Strut	
11	6462258B	2	Rear Gas Legend Shock Absorber	
12	BLEB001	1	Brake Line Extension Bracket	
13	77ACMB-LCSAHARA-GVM-IND	2	Category 6 Indicators ADR 13/00	
14		2	Lovells Rear Mudflaps	
15		1	Federal Compliance plate with revised GVM (Pre-registered Vehicles)	
16		1	Re-Tension U-Bolts Warning Decal	
17		1	Tyre Loading Placard with revised axle capacities	
18		1	GVM Upgrade Owners Manual	
19		1	Fitting Instruction Manual	

SUSPENSION KITS

Kit Type	Part No.	Qty. per vehicle	Kit Description	Retail Price
GVM	ISUZKIT008-GVM	1	GVM Upgrade Kit (Fitted Price)	\$ 5,200.00

Optional parts

Item	Part No.	Qty. per vehicle	Option Description	List Price EACH
1A	LOVUCA-D/MAX	1	Lovells Extreme Upper Control Arm kit	\$ 995.00
2A	LPWR110402	1	Lovells Radiator Closemesh	\$ 2,600.00
3A	77ACMB-D/MAX	1	Patch Harness for Models with Bi LED Headlights	\$ 228.43

Part No.	Load Rating	Description
All spring load ratings are an approximate only. Vehicle ride heights will vary depending on load and accessories fitted.		
IFS-002	0 to 100kg Constant Load	Suits Steel Bull Bar
IFR-002	0 to 100kg Constant Load	Suits Steel Bull Bar, Winch, Underbody Protection etc.
IS-003EHD	400 to 500kg Constant Load	To GVM

The solution for owners/managers of Isuzu D Max 4x4 vehicles who have a need to carry loads to a GVM of 3600kg (up from 3100kg standard GVM), while at the same time meeting the practical and documentary compliance requirements of Work Safety, Police Licensing, Insurance, Lessors and Fleet Managers.
This kit is approved by the Australian Government's Department of Infrastructure, Transport, Regional Development and Communications Manufacturers compliance plate. (Australian Compliance ONLY)

Lovells Compliance Plate Approval Number (CPA) 51540

Above price includes fitting by a Lovells Authorised Fitter and does not include GST

*****NOTE: The above GVM Upgrade can be supplied under State Compliance (for already registered vehicles) and the vehicle individually engineered for the State of registration. Includes State engineering certificate or certification plate. Kit part numbers, order forms, details and pricing are available upon application**

Mazda- BT50
MY21 Pick Up and Tray Back
07/2020 On
Coil/Leaf

3600KG GVM Upgrade Kit (Fitted Price)-Federal Compliance

KIT COMPONENTS

Item	Part No.	Qty. per vehicle	Description	SOLD AS KIT ONLY
1	IFS-002	2	HD Front Coil Springs- Standard Height (Option 1) Vehicles with minimal load bearing front accessories. Axle Capacities under 1300kg	
2	IFR-002	2	HD Front Coil Springs- Raised (Option 2) Vehicles with load bearing accessories, i.e. Steel Bull bar, Winch, Dual Batteries	
3	IS-003EHD	2	Rear Leaf Springs- Raised Extra Heavy Duty	
4	N73254	1	Rear Urethane Bush Kit- Spring Front Eyes	
5	N73474	1	Rear Urethane Bush Kit- Rear Top Shackle	
6	N71021	1	Rear Urethane Bush Kit- Rear Spring Eye	
7	UBL-06	4	Rear U-Bolts	
8	LGSK393	2	Rear Greasable Shackle Kit	
9	LGPK387-2	2	Rear Pin Kit (Non Greasable)	
10	64611038LH-2.0ADJMONO	1	Front 2.0" Mono Tube Strut with Remote Reservoir	
11	64611038RH-2.0ADJMONO	1	Front 2.0" Mono Tube Strut with Remote Reservoir	
12	6462258B-2.0ADJMONO	2	Rear 2.0" Mono Tube Strut with Remote Reservoir	
13	BLEB001	1	Brake Line Extension Bracket	
14	77ACMB-LCSAHARA-GVM-IND	2	Category 6 Indicators ADR 13/00	
15		2	Lovells Rear Mudflaps	
16		1	Federal Compliance plate with revised GVM (Pre-registered Vehicles)	
17		1	Re-Tension U-Bolts Warning Decal	
18		1	Tyre Loading Placard with revised axle capacities	
19		1	GVM Upgrade Owners Manual	
20		1	Fitting Instruction Manual	

SUSPENSION KITS

Kit Type	Part No.	Qty. per vehicle	Kit Description	Retail Price
GVM	ISUZKIT008-GVM-PLAT	1	GVM Upgrade Kit (Fitted Price)	\$ 5,700.00

Optional parts

Item	Part No.	Qty. per vehicle	Option Description	List Price EACH
1A	LOVUCA-D/MAX	1	Lovells Extreme Upper Control Arm kit	\$ 995.00
2A	LPWR110402	1	Lovells Radiator Closemesh	\$ 2,600.00
3A	77ACMB-D/MAX	1	Patch Harness for Models with Bi LED Headlights	\$ 228.43

Part No.	Load Rating	Description
All spring load ratings are an approximate only. Vehicle ride heights will vary depending on load and accessories fitted.		
IFS-002	0 to 100kg Constant Load	Suits Steel Bull Bar
IFR-002	0 to 100kg Constant Load	Suits Steel Bull Bar, Winch, Underbody Protection etc.
IS-003EHD	400 to 500kg Constant Load	To GVM

*The solution for owners/managers of Isuzu D Max 4x4 vehicles who have a need to carry loads to a GVM of 3600kg (up from 3100kg standard GVM), while at the same time meeting the practical and documentary compliance requirements of Work Safety, Police Licensing, Insurance, Lessors and Fleet Managers.
 This kit is approved by the Australian Government's Department of Infrastructure, Transport, Regional Development and Communications Manufacturers compliance plate. (Australian Compliance ONLY)*

Lovells Compliance Plate Approval Number (CPA) 51540

Above price includes fitting by a Lovells Authorised Fitter and does not include GST

*****NOTE: The above GVM Upgrade can be supplied under State Compliance (for already registered vehicles) and the vehicle individually engineered for the State of registration. Includes State engineering certificate or certification plate. Kit part numbers, order forms, details and pricing are available upon application**

MITSUBISHI- Challenger
PA Wagon
3/98-8/00
Torsion Bar/Leaf

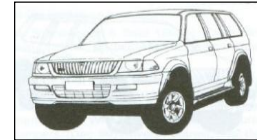

KIT COMPONENTS

Item	Part No.	Qty. per vehicle	Description	List Price EACH
1	MITS019	1 Pair	Front Heavy Duty Torsion Bars	\$ 660.33
2	MA-6	2	Rear Leaf Springs- Raised (B)	\$ 479.99
3	MA-6HD	2	Rear Leaf Springs- Raised Heavy Duty (C)	\$ 548.56
4	UBL-01	4	Rear U-Bolts	\$ 24.61
5	64612469S	2	Front Gas Legend Shock Absorber	\$ 227.70
6	64611009	2	Rear Gas Legend Shock Absorber	\$ 244.03

SUSPENSION KITS

Kit Type	Part No.	Qty. per vehicle	Kit Description	List Price EACH
B	MITSKIT001-B	1	RAISED	\$ 2,662.21
C	MITSKIT001-C	1	RAISED HEAVY DUTY	\$ 2,799.36

Part No.	Load Rating	Description
All spring load ratings are an approximate only. Vehicle ride heights will vary depending on load and accessories fitted.		
MA-6	0 to 100kg Constant Load	
MA-6HD	100 to 150kg Constant Load	

MITSUBISHI- Challenger
PA (Series II) Wagon
9/00-10/03
Torsion Bar/Coil

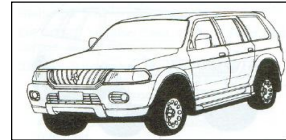

KIT COMPONENTS

Item	Part No.	Qty. per vehicle	Description	List Price EACH
1	MITS019	1 Pair	Front Heavy Duty Torsion Bars	\$ 660.33
2	CRS-65	2	Rear Coil Springs- Standard Height (A)	\$ 126.26
3	CRR-65	2	Rear Coil Springs- Raised (B)	\$ 126.26
4	CRS-23	2	Rear Coil Springs- Raised Heavy Duty (C)	\$ 126.26
5	6462543S	2	Front Gas Legend Shock Absorber	\$ 244.03
6	64611009	2	Rear Gas Legend Shock Absorber	\$ 244.03

SUSPENSION KITS

Kit Type	Part No.	Qty. per vehicle	Kit Description	List Price EACH
A	MITSKIT002-A	1	STANDARD HEIGHT	\$ 1,888.95
B	MITSKIT002-B	1	RAISED	\$ 1,888.95
C	MITSKIT002-C	1	RAISED HEAVY DUTY	\$ 1,888.95

Part No.	Load Rating	Description
All spring load ratings are an approximate only. Vehicle ride heights will vary depending on load and accessories fitted.		
CRS-65	0 to 100kg Constant Load	
CRR-65	0 to 100kg Constant Load	
CRS-23	0 to 100kg Constant Load	

MITSUBISHI- Challenger
KH Wagon
12/09 on
Coil/Coil

KIT COMPONENTS

Item	Part No.	Qty. per vehicle	Description	List Price EACH
1	CFS-95	2	Front Coil Springs- Std (A)	\$ 126.26
2	CFR-95	2	Front Coil Springs- Raised (B)	\$ 126.26
3	CFR-95HD	2	Front Coil Springs- Raised Heavy Duty (C)	\$ 126.26
4	CRS-69	2	Rear Coil Springs- Std (B)	\$ 126.26
5	CRR-69	2	Rear Coil Springs- Raised (B)	\$ 126.26
6	CRR-69HD	2	Rear Coil Springs- Raised Heavy Duty (C)	\$ 126.26
7	64611015	2	Front Gas Legend Shock Absorber	\$ 334.60
8	64611034	2	Rear Gas Legend Shock Absorber	\$ 244.03

SUSPENSION KITS

Kit Type	Part No.	Qty. per vehicle	Kit Description	List Price EACH
A	MITSKIT016-A	1	STANDARD	\$ 1,662.29
B	MITSKIT016-B	1	RAISED	\$ 1,662.29
C	MITSKIT016-C	1	RAISED HEAVY DUTY	\$ 1,662.29

Part No.	Load Rating	Description
All spring load ratings are an approximate only. Vehicle ride heights will vary depending on load and accessories fitted.		
CFS-95	0 to 100kg Constant Load	Suits Steel Bull Bar
CFR-95	0 to 100kg Constant Load	Suits Steel Bull Bar
CFR-95HD	100 to 150kg Constant Load	Suits Steel Bull Bar, Winch, Underbody Protection etc.
CRS-69	0 to 100kg Constant Load	
CRR-69	0 to 100kg Constant Load	
CRR-69HD	150 to 250kg Constant Load	

MITSUBISHI- Pajero
NA-NC Wagon SWB (Shogun or Montero- EXPORT)
1/83-8/88
Torsion Bar/Leaf



KIT COMPONENTS

Item	Part No.	Qty. per vehicle	Description	List Price EACH
1	MITS013	1 Pair	Front Heavy Duty Torsion Bars	\$ 660.33
2	MA-1	2	Rear Leaf Springs- Raised (B)	\$ 443.12
3	MA-1HD	2	Rear Leaf Springs- Raised Heavy Duty (C)	\$ 571.42
4	N71600	1	Rear Urethane Bush Kit- Spring Front eye	\$ 51.41
5	N71056	1	Rear Urethane Bush Kit- Spring Rear eye	\$ 45.78
6	N71050	1	Rear Urethane Bush Kit- Shackle	\$ 46.89
7	UBL-01	4	Rear U-Bolts	\$ 24.61
8	LGSKMIT-001	2	Rear Greasable Shackle Kit	\$ 53.93
9	LGPKMIT-004	2	Rear Greasable Pin Kit	\$ 60.19
10	64612543	2	Front Gas Legend Shock Absorber	\$ 244.03
11	6462258B	2	Rear Gas Legend Shock Absorber	\$ 269.38

SUSPENSION KITS

Kit Type	Part No.	Qty. per vehicle	Kit Description	List Price EACH
B	MITSKIT003-B	1	RAISED	\$ 3,044.14
C	MITSKIT003-C	1	RAISED HEAVY DUTY	\$ 3,300.74

Part No.	Load Rating	Description
All spring load ratings are an approximate only. Vehicle ride heights will vary depending on load and accessories fitted.		
MA-1	0 to 100kg Constant Load	
MA-1HD	100 to 150kg Constant Load	

MITSUBISHI- Pajero
NB-NG Wagon LWB (Shogun or Montero- EXPORT)
11/84-5/91
Torsion Bar/Leaf



KIT COMPONENTS

Item	Part No.	Qty. per vehicle	Description	List Price EACH
1	MITS013	1 Pair	Front Heavy Duty Torsion Bars	\$ 660.33
2	MA-2	2	Rear Leaf Springs- Raised (B)	\$ 510.00
3	MA-2HD	2	Rear Leaf Springs- Raised Heavy Duty (C)	\$ 580.44
4	N71600	1	Rear Urethane Bush Kit- Spring Front eye	\$ 51.41
5	N71056	1	Rear Urethane Bush Kit- Spring Rear eye	\$ 45.78
6	N71050	1	Rear Urethane Bush Kit- Shackle	\$ 46.89
7	UBL-01	4	Rear U-Bolts	\$ 24.61
8	LGSKMIT-001	2	Rear Greasable Shackle Kit	\$ 53.93
9	LGPKMIT-004	2	Rear Greasable Pin Kit	\$ 60.19
10	64612543	2	Front Gas Legend Shock Absorber	\$ 244.03
11	6462258B	2	Rear Gas Legend Shock Absorber	\$ 269.38

SUSPENSION KITS

Kit Type	Part No.	Qty. per vehicle	Kit Description	List Price EACH
B	MITSKIT004-B	1	RAISED	\$ 3,177.90
C	MITSKIT004-C	1	RAISED HEAVY DUTY	\$ 3,318.78

Part No.	Load Rating	Description
All spring load ratings are an approximate only. Vehicle ride heights will vary depending on load and accessories fitted.		
MA-2	0 to 100kg Constant Load	
MA-2HD	100 to 150kg Constant Load	

MITSUBISHI- Pajero
NF-NG Wagon LWB (Shogun or Montero- EXPORT)
9/88-5/91
Torsion Bar/Coil



KIT COMPONENTS

Item	Part No.	Qty. per vehicle	Description	List Price EACH
1	MITS013	1 Pair	Front Heavy Duty Torsion Bars	\$ 660.33
2	CRS-23	2	Rear Coil Springs- Standard Height (A)	\$ 126.26
3	CRR-23	2	Rear Coil Springs- Raised (B)	\$ 126.26
4	64612543	2	Front Gas Legend Shock Absorber	\$ 244.03
5	64611009	2	Rear Gas Legend Shock Absorber	\$ 244.03

SUSPENSION KITS

Kit Type	Part No.	Qty. per vehicle	Kit Description	List Price EACH
A	MITSKIT005-A	1	STANDARD HEIGHT	\$ 1,888.96
B	MITSKIT005-B	1	RAISED	\$ 1,888.96

Part No.	Load Rating	Description
All spring load ratings are an approximate only. Vehicle ride heights will vary depending on load and accessories fitted.		
CRS-23	0 to 100kg Constant Load	
CRR-23	100 to 150kg Constant Load	

MITSUBISHI- Pajero
NH,NJ,NK,NL Wagon SWB (Shogun or Montero- EXPORT)
5/91-4/00
Torsion Bar/Coil

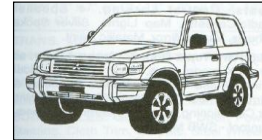

KIT COMPONENTS

Item	Part No.	Qty. per vehicle	Description	List Price EACH
1	MITS013 OR MITS019	1 Pair	Front Heavy Duty Torsion Bars	\$ 660.33
2	CRR-53	2	Rear Coil Springs- Raised (B)	\$ 126.26
3	6462543S	2	Front Gas Legend Shock Absorber	\$ 244.03
4	64612547	2	Rear Gas Legend Shock Absorber	\$ 266.90

SUSPENSION KITS

Kit Type	Part No.	Qty. per vehicle	Kit Description	List Price EACH
B	MITSKIT006-B	1	RAISED	\$ 1,934.70

Part No.	Load Rating	Description
All spring load ratings are an approximate only. Vehicle ride heights will vary depending on load and accessories fitted.		
CRR-53	0 to 100kg Constant Load	

Note:

NJ Pajero- Please specify Torsion Bar length at point of order. MITS013 = 1282mm MITS019 = 1307mm

MITSUBISHI- Pajero
NH,NJ,NK,NL Wagon LWB (Shogun or Montero- EXPORT)
5/91-4/00
Torsion Bar/Coil

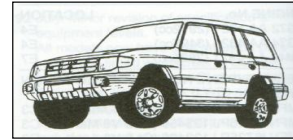

KIT COMPONENTS

Item	Part No.	Qty. per vehicle	Description	List Price EACH
1	MITS019	1 Pair	Front Heavy Duty Torsion Bars	\$ 660.33
2	CRS-32	2	Rear Coil Springs- Standard Height (A)	\$ 161.27
3	CRR-32	2	Rear Coil Springs- Raised (B)	\$ 161.27
4	CRR-32HD	2	Rear Coil Springs- Raised Heavy Duty (C)	\$ 177.95
5	6462543S	2	Front Gas Legend Shock Absorber	\$ 244.03
6	64612547	2	Rear Gas Legend Shock Absorber	\$ 266.90

SUSPENSION KITS

Kit Type	Part No.	Qty. per vehicle	Kit Description	List Price EACH
A	MITSKIT007-A	1	STANDARD HEIGHT	\$ 2,004.72
B	MITSKIT007-B	1	RAISED	\$ 2,004.72
C	MITSKIT007-C	1	RAISED HEAVY DUTY	\$ 2,038.09

Part No.	Load Rating	Description
All spring load ratings are an approximate only. Vehicle ride heights will vary depending on load and accessories fitted.		
CRS-32	0 to 100kg Constant Load	
CRR-32	0 to 100kg Constant Load	
CRR-32HD	150 to 200kg Constant Load	

MITSUBISHI- Pajero
NM Wagon LWB (Shogun or Montero- EXPORT)
5/00-10/02
Coil/Coil

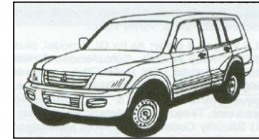

KIT COMPONENTS

Item	Part No.	Qty. per vehicle	Description	List Price EACH
1	CFS-90	2	Front Coil Springs- Standard Height (A)	\$ 126.26
2	CFR-90	2	Front Coil Springs- Raised (B)	\$ 126.26
3	CFR-90HD	2	Front Coil Springs- Raised Heavy Duty (C)	\$ 144.58
4	CFR-90EHD	2	Front Coil Springs- Raised Extra Heavy Duty	\$ 144.57
5	CRS-91	2	Rear Coil Springs- Standard Height (A)	\$ 161.25
6	CRR-91	2	Rear Coil Springs- Raised (B)	\$ 161.25
7	CRR-91HD	2	Rear Coil Springs- Raised Heavy Duty (C)	\$ 177.94
8	64611005	2	Front Gas Legend Shock Absorber	\$ 329.12
9	64611006	2	Rear Gas Legend Shock Absorber	\$ 247.63

SUSPENSION KITS

Kit Type	Part No.	Qty. per vehicle	Kit Description	List Price EACH
A	MITSKIT008-A	1	STANDARD HEIGHT	\$ 1,728.54
B	MITSKIT008-B	1	RAISED	\$ 1,728.54
C	MITSKIT008-C	1	RAISED HEAVY DUTY	\$ 1,798.55

ACCESSORIES (Not included in Kit)

Item	Part No.	Qty. per vehicle	Accessory Description	List Price EACH
1A	N23255	1	Front Urethane Bush Kit-Sway Bar-Link Assbly	\$ 153.77
2A	N23255	1	Rear Urethane Bush Kit-Sway Bar-Link Assbly	\$ 153.77

MITSUBISHI- Pajero
NM Wagon SWB (Export)- (Shogun or Montero- EXPORT)
5/00-10/02
Coil/Coil

KIT COMPONENTS

Item	Part No.	Qty. per vehicle	Description	List Price EACH
1	CFR-90	2	Front Coil Springs- Raised (B)	\$ 126.26
2	CFR-90HD	2	Front Coil Springs- Raised Heavy Duty (C)	\$ 144.58
3	CFR-90EHD	2	Front Coil Springs- Raised Extra Heavy Duty	\$ 144.57
4	CRS-91	2	Rear Coil Springs- Raised (B)	\$ 161.25
5	CRR-91	2	Rear Coil Springs- Raised Heavy Duty (C)	\$ 161.25
6	64611005	2	Front Gas Legend Shock Absorber	\$ 329.12
7	64611006	2	Rear Gas Legend Shock Absorber	\$ 247.63

SUSPENSION KITS

Kit Type	Part No.	Qty. per vehicle	Kit Description	List Price EACH
B	MITSKIT009-B	1	RAISED	\$ 1,728.54
C	MITSKIT009-C	1	RAISED HEAVY DUTY	\$ 1,765.19

ACCESSORIES (Not included in Kit)

Item	Part No.	Qty. per vehicle	Accessory Description	List Price EACH
1A	N23255	1	Front Urethane Bush Kit-Sway Bar-Link Assbly	\$ 153.77
2A	N23255	1	Rear Urethane Bush Kit-Sway Bar-Link Assbly	\$ 153.77

Part No.	Load Rating	Description
All spring load ratings are an approximate only. Vehicle ride heights will vary depending on load and accessories fitted.		
CFS-90	0 to 100kg Constant Load	Suits Steel Bull Bar
CFR-90	0 to 100kg Constant Load	Suits Steel Bull Bar
CFR-90HD	100 to 150kg Constant Load	Suits Steel Bull Bar, Winch, Underbody Protection etc.
CFR-90EHD	150 to 200kg Constant Load	Suits Steel Bull Bar, Winch, Underbody Protection etc.
CRS-91	0 to 100kg Constant Load	
CRR-91	0 to 100kg Constant Load	
CRR-91HD	150 to 250kg Constant Load	

MITSUBISHI- Pajero
NP-NW Wagon LWB (Petrol) (Shogun or Montero- EXPORT)
11/02-00/14
Coil/Coil

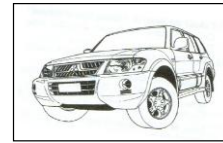

KIT COMPONENTS

Item	Part No.	Qty. per vehicle	Description	List Price EACH
1	CFR-90	2	Front Coil Springs- Raised (B)	\$ 126.26
2	CFR-90HD	2	Front Coil Springs- Raised Heavy Duty (C)	\$ 144.58
3	CFR-90EHD	2	Front Coil Springs- Raised Extra Heavy Duty	\$ 144.57
4	CRR-91	2	Rear Coil Springs- Raised (B)	\$ 161.25
5	CRR-91HD	2	Rear Coil Springs- Raised Heavy Duty (C)	\$ 177.94
6	64611005	2	Front Gas Legend Shock Absorber	\$ 329.12
7	64611006	2	Rear Gas Legend Shock Absorber	\$ 247.63

SUSPENSION KITS

Kit Type	Part No.	Qty. per vehicle	Kit Description	List Price EACH
B	MITSKIT010-B	1	RAISED	\$ 1,728.54
C	MITSKIT010-C	1	RAISED HEAVY DUTY	\$ 1,798.55

ACCESSORIES (Not included in Kit)

Item	Part No.	Qty. per vehicle	Accessory Description	List Price EACH
1A	N23255	1	Rear Urethane Bush Kit-Sway Bar-Link Assbly	\$ 153.77

MITSUBISHI- Pajero
NP-NW Wagon LWB (Diesel) (Shogun or Montero- EXPORT)
11/02-00/14
Coil/Coil



KIT COMPONENTS

Item	Part No.	Qty. per vehicle	Description	List Price EACH
1	CFS-90	2	Front Coil Springs- Standard Height (A)	\$ 126.26
2	CFR-90	2	Front Coil Springs- Raised (B)	\$ 126.26
3	CFR-90HD	2	Front Coil Springs- Raised Heavy Duty (C)	\$ 144.58
4	CFR-90EHD	2	Front Coil Springs- Raised Extra Heavy Duty	\$ 144.57
5	CRS-91	2	Rear Coil Springs- Standard Height (A)	\$ 161.25
6	CRR-91	2	Rear Coil Springs- Raised (B)	\$ 161.25
7	CRR-91HD	2	Rear Coil Springs- Raised Heavy Duty (C)	\$ 177.94
8	64611005	2	Front Gas Legend Shock Absorber	\$ 329.12
9	64611006	2	Rear Gas Legend Shock Absorber	\$ 247.63

SUSPENSION KITS

Kit Type	Part No.	Qty. per vehicle	Kit Description	List Price EACH
A	MITSKIT011-A	1	STANDARD HEIGHT	\$ 1,728.54
B	MITSKIT011-B	1	RAISED	\$ 1,728.54
C	MITSKIT011-C	1	RAISED HEAVY DUTY	\$ 1,798.55

ACCESSORIES (Not included in Kit)

Item	Part No.	Qty. per vehicle	Accessory Description	List Price EACH
1A	N23255	1	Rear Urethane Bush Kit-Sway Bar-Link Assbly	\$ 153.77

Part No.	Load Rating	Description
All spring load ratings are an approximate only. Vehicle ride heights will vary depending on load and accessories fitted.		
CFS-90	0 to 100kg Constant Load	Suits Steel Bull Bar
CFR-90	0 to 100kg Constant Load	Suits Steel Bull Bar
CFR-90HD	100 to 150kg Constant Load	Suits Steel Bull Bar, Winch, Underbody Protection etc.
CFR-90EHD	150 to 200kg Constant Load	Suits Steel Bull Bar, Winch, Underbody Protection etc.
CRS-91	0 to 100kg Constant Load	
CRR-91	0 to 100kg Constant Load	
CRR-91HD	150 to 250kg Constant Load	

MITSUBISHI- Pajero
NT-NW Wagon LWB (Petrol and Diesel)
8/08 on
Coil/Coil

KIT COMPONENTS

Item	Part No.	Qty. per vehicle	Description	List Price EACH
1	CFS-90	2	Front Coil Springs- Standard Height (A)	\$ 126.26
2	CFR-90	2	Front Coil Springs- Raised (B)	\$ 126.26
3	CFR-90HD	2	Front Coil Springs- Raised Heavy Duty (C)	\$ 144.58
4	CFR-90EHD	2	Front Coil Springs- Raised Extra Heavy Duty	\$ 144.57
5	CRS-91	2	Rear Coil Springs- Standard Height (A)	\$ 161.25
6	CRR-91	2	Rear Coil Springs- Raised (B)	\$ 161.25
7	CRR-91HD	2	Rear Coil Springs- Raised Heavy Duty (C)	\$ 177.94
8	64611005	2	Front Gas Legend Shock Absorber	\$ 329.12
9	64611006	2	Rear Gas Legend Shock Absorber	\$ 247.63

SUSPENSION KITS

Kit Type	Part No.	Qty. per vehicle	Kit Description	List Price EACH
A	MITSKIT015-A	1	STANDARD HEIGHT	\$ 1,728.54
B	MITSKIT015-B	1	RAISED	\$ 1,728.54
C	MITSKIT015-C	1	RAISED HEAVY DUTY	\$ 1,798.55

Part No.	Load Rating	Description
All spring load ratings are an approximate only. Vehicle ride heights will vary depending on load and accessories fitted.		
CFS-90	0 to 100kg Constant Load	Suits Steel Bull Bar
CFR-90	0 to 100kg Constant Load	Suits Steel Bull Bar
CFR-90HD	100 to 150kg Constant Load	Suits Steel Bull Bar, Winch, Underbody Protection etc.
CFR-90EHD	150 to 200kg Constant Load	Suits Steel Bull Bar, Winch, Underbody Protection etc.
CRS-91	0 to 100kg Constant Load	
CRR-91	0 to 100kg Constant Load	
CRR-91HD	150 to 250kg Constant Load	

MITSUBISHI- Pajero
NW Wagon SWB (Petrol and Diesel)
10/12 on
Coil/Coil

KIT COMPONENTS

Item	Part No.	Qty. per vehicle	Description	List Price EACH
1	CFS-90	2	Front Coil Springs- Standard Height (A) (Petrol Only)	\$ 126.26
2	CFR-90	2	Front Coil Springs- Raised (B) (Use A Kit for Petrol Version)	\$ 126.26
3	CFR-90HD	2	Front Coil Springs- Raised Heavy Duty (C)	\$ 144.58
4	CFR-90EHD	2	Front Coil Springs- Raised Extra Heavy Duty (Diesel Only)	\$ 144.57
5	CRS-93	2	Rear Coil Springs- Standard Height (A)	\$ 154.37
6	CRR-93	2	Rear Coil Springs- Raised (B)	\$ 154.37
7	CRS-91	2	Rear Coil Springs- Raised Heavy Duty (C)	\$ 161.25
8	64611005	2	Front Gas Legend Shock Absorber	\$ 329.12
9	64611006	2	Rear Gas Legend Shock Absorber	\$ 247.63

SUSPENSION KITS

Kit Type	Part No.	Qty. per vehicle	Kit Description	List Price EACH
A	MITSKIT017-A	1	STANDARD HEIGHT	\$ 1,714.77
B	MITSKIT017-B	1	RAISED	\$ 1,714.77
C	MITSKIT017-C	1	RAISED HEAVY DUTY	\$ 1,765.19

Part No.	Load Rating	Description
All spring load ratings are an approximate only. Vehicle ride heights will vary depending on load and accessories fitted.		
CFS-90	0 to 100kg Constant Load	Suits Steel Bull Bar
CFR-90	0 to 100kg Constant Load	Suits Steel Bull Bar
CFR-90HD	100 to 150kg Constant Load	Suits Steel Bull Bar, Winch, Underbody Protection etc.
CFR-90EHD	150 to 200kg Constant Load	Suits Steel Bull Bar, Winch, Underbody Protection etc.
CRS-93	0 to 100kg Constant Load	
CRR-93	0 to 100kg Constant Load	
CRS-91	0 to 100kg Constant Load	

MITSUBISHI- Triton (Strada or L200- EXPORT)
ME,MF,MG,MH,MJ Pick Up and Tray Back
10/86-8/96
Torsion Bar/Leaf



KIT COMPONENTS

Item	Part No.	Qty. per vehicle	Description	List Price EACH
1	MITSO15B (6/91-93 build date)	1 Pair	Front Heavy Duty Torsion Bars	\$ 626.18
2	MITSO15C (93 on build date)	1 Pair	Front Heavy Duty Torsion Bars	\$ 660.33
3	MA-5	2	Rear Leaf Springs- Raised (B)	\$ 633.31
4	MA-5HD	2	Rear Leaf Springs- Raised Heavy Duty (C)	\$ 687.25
5	N72127	1	Rear Urethane Bush Kit- Spring Front eye	\$ 94.76
6	N71056	1	Rear Urethane Bush Kit- Spring Rear eye	\$ 45.78
7	N71050	1	Rear Urethane Bush Kit- Shackle	\$ 46.89
8	UBL-01	4	Rear U-Bolts	\$ 24.61
9	LGSKMIT-001	2	Rear Greasable Shackle Kit	\$ 53.93
10	LGPKMIT-004	2	Rear Greasable Pin Kit	\$ 60.19
11	64612543	2	Front Gas Legend Shock Absorber	\$ 244.03
12	6462258B	2	Rear Gas Legend Shock Absorber	\$ 269.38

SUSPENSION KITS

Kit Type	Part No.	Qty. per vehicle	Kit Description	List Price EACH
B	MITSKIT012-B	1	RAISED	\$ 3,433.71
C	MITSKIT012-C	1	RAISED HEAVY DUTY	\$ 3,541.60

Part No.	Load Rating	Description
All spring load ratings are an approximate only. Vehicle ride heights will vary depending on load and accessories fitted.		
MA-5	0 to 100kg Constant Load	
MA-5HD	150 to 250kg Constant Load	

MITSUBISHI- Triton (Strada or L200- EXPORT)
MK-MY Pick Up and Tray Back
9/96-6/06
Torsion Bar/Leaf

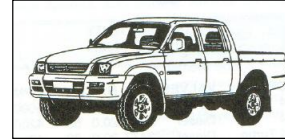

KIT COMPONENTS

Item	Part No.	Qty. per vehicle	Description	List Price EACH
1	MITS015C	1 Pair	Front Heavy Duty Torsion Bars	\$ 660.33
2	MA-5	2	Rear Leaf Springs- Raised (B)	\$ 633.31
3	MA-5HD	2	Rear Leaf Springs- Raised Heavy Duty (C)	\$ 687.25
4	N72127	1	Rear Urethane Bush Kit- Spring Front eye	\$ 94.76
5	N71056	1	Rear Urethane Bush Kit- Spring Rear eye	\$ 45.78
6	N71050	1	Rear Urethane Bush Kit- Shackle	\$ 46.89
7	UBL-01	4	Rear U-Bolts	\$ 24.61
8	LGSKMIT-001	2	Rear Greasable Shackle Kit	\$ 53.93
9	LGPKMIT-004	2	Rear Greasable Pin Kit	\$ 60.19
10	6462543S	2	Front Gas Legend Shock Absorber	\$ 244.03
11	6462258B	2	Rear Gas Legend Shock Absorber	\$ 269.38

SUSPENSION KITS

Kit Type	Part No.	Qty. per vehicle	Kit Description	List Price EACH
B	MITSKIT013-B	1	RAISED	\$ 3,467.85
C	MITSKIT013-C	1	RAISED HEAVY DUTY	\$ 3,575.75

Part No.	Load Rating	Description
All spring load ratings are an approximate only. Vehicle ride heights will vary depending on load and accessories fitted.		
MA-5	0 to 100kg Constant Load	
MA-5HD	150 to 250kg Constant Load	

MITSUBISHI- Triton (Strada or L200- EXPORT)
ML-MN Pick Up and Dual Cab
7/06-10/15
Coil/Leaf



KIT COMPONENTS

Item	Part No.	Qty. per vehicle	Description	List Price EACH
1	CFR-95	2	Front Coil Springs- Raised (B)	\$ 126.26
2	CFR-95HD	2	Front Coil Springs- Raised Heavy Duty (C)	\$ 126.26
3	MA-7	2	Rear Leaf Springs- Raised (B)	\$ 647.51
4	MA-7HD	2	Rear Leaf Springs- Raised Heavy Duty (C)	\$ 726.74
5	N73256	1	Rear Urethane Bush Kit- Spring Front eye	\$ 93.70
6	N71056	1	Rear Urethane Bush Kit- Spring Rear eye	\$ 45.78
7	N71050	1	Rear Urethane Bush Kit- Shackle	\$ 46.89
8	UBL-38	4	Rear U-Bolts	\$ 24.61
9	LGSKMIT-001	2	Rear Greasable Shackle Kit	\$ 53.93
10	LGPK387-2	2	Rear Greasable Pin Kit	\$ 47.08
11	64611015	2	Front Gas Legend Strut	\$ 334.60
12	64611016	2	Rear Gas Legend Shock Absorber	\$ 244.03

Note: Front STRUTS P/N 64611015 are supplied with a gold removable lower spring seat & a 10mm spacer tube. The spacer tube will raise the front height by an extra 15mm if required. Lovells recommend using the spacer for Raised (B Kit) when steel bull bar and winch are fitted. Lovells do not recommend using the spacer with Raised Heavy Duty (C Kit).

SUSPENSION KITS

Kit Type	Part No.	Qty. per vehicle	Kit Description	List Price EACH
B	MITSKIT014-B	1	RAISED	\$ 3,191.60
C	MITSKIT014-C	1	RAISED HEAVY DUTY	\$ 3,350.07

ACCESSORIES (Not included in Kit)

Item	Part No.	Qty. per vehicle	Accessory Description	List Price EACH
1A	N13208	1	Front Urethane Kit- Steering Rack & Pinion Mount	\$ 161.50
2A	N53292	1	Front Urethane Bush Kit- Control Arm- Lower Inner	\$ 287.07
3A	N53293	1	Front Urethane Bush Kit- Control Arm- Upper Inner	\$ 156.75
4A	24211002	1	Driveline Anti-Vibration Alignment Kit	\$ 2,171.76

Part No.	Load Rating	Description
All spring load ratings are an approximate only. Vehicle ride heights will vary depending on load and accessories fitted.		
CFR-95	0 to 100kg Constant Load	Suits Steel Bull Bar
CFR-95HD	100 to 150kg Constant Load	Suits Steel Bull Bar, Winch, Underbody Protection etc.
MA-7	0 to 100kg Constant Load	
MA-7HD	150 to 250kg Constant Load	

Highlighted Accessories: Lovells strongly recommend fitting these accessories when using Raised OR Raised Heavy Duty springs.

Note: When fitting raised rear springs to this vehicle, driveline vibration can occur. Lovells recommend using the above driveline anti-vibration alignment kit.
 Kit includes new complete twin assembly drive shaft, new firmer centre bearing, sliding splines and double cardan to cater for increased driveline angles. Note that this kit may not totally eliminate vibration/shudder. Above price is special net and no discount applies.

mitsubishi- Triton
MQ Pick Up and Dual Cab
10/15 on
Coil/Leaf

KIT COMPONENTS

Item	Part No.	Qty. per vehicle	Description	List Price EACH
1	CFR-95	2	Front Coil Springs- Raised (B)	\$ 126.26
2	CFR-95HD	2	Front Coil Springs- Raised Heavy Duty (C)	\$ 126.26
3	MA-18	2	Rear Leaf Springs- Raised (B)	\$ 771.87
4	MA-18HD	2	Rear Leaf Springs- Raised Heavy Duty (C)	\$ 868.56
5	N73453	1	Rear Urethane Bush Kit- Spring Front eye	\$ 88.41
6	N73454	1	Rear Urethane Bush Kit- Spring Rear eye	\$ 39.07
7	N71050	1	Rear Urethane Bush Kit- Shackle	\$ 46.89
8	UBL-06	4	Rear U-Bolts	\$ 24.61
9	LGSKMIT-002	2	Rear Greasable Shackle Kit	\$ 96.30
10	LGPK387-2	2	Rear Greasable Pin Kit	\$ 47.08
11	64611015	2	Front Gas Legend Strut	\$ 334.60
12	64611045	2	Rear Gas Legend Shock Absorber	\$ 273.31

Note: Front STRUTS P/N 64611015 are supplied with a gold removable lower spring seat & a 10mm spacer tube. The spacer tube will raise the front height by an extra 15mm if required. Lovells recommend using the spacer for Raised (B Kit) when steel bull bar and winch are fitted. Lovells do not recommend using the spacer with Raised Heavy Duty (C Kit).

SUSPENSION KITS

Kit Type	Part No.	Qty. per vehicle	Kit Description	List Price EACH
B	MITSKIT018-B	1	RAISED	\$ 3,571.64
C	MITSKIT018-C	1	RAISED HEAVY DUTY	\$ 3,765.03

Part No.	Load Rating	Description
All spring load ratings are an approximate only. Vehicle ride heights will vary depending on load and accessories fitted.		
CFR-95	0 to 100kg Constant Load	Suits Steel Bull Bar
CFR-95HD	100 to 150kg Constant Load	Suits Steel Bull Bar, Winch, Underbody Protection etc.
MA-18	0 to 100kg Constant Load	
MA-18HD	150 to 250kg Constant Load	

NISSAN- Navara
D21 Pick Up and Tray Back
1/86-3/97
Torsion Bar/Leaf

KIT COMPONENTS

Item	Part No.	Qty. per vehicle	Description	List Price EACH
1	NISS013	1 Pair	Front Heavy Duty Torsion Bars	\$ 660.33
2	NP-11	2	Rear Leaf Springs- Raised (B)	\$ 465.73
3	NP-11HD	2	Rear Leaf Springs- Raised Heavy Duty (C)	\$ 532.38
4	N71646	1	Rear Urethane Bush Kit- Spring Front eye	\$ 106.74
5	N71060	1	Rear Urethane Bush Kit- Spring Rear eye and Shackle	\$ 82.78
6	N71190	1	Rear Urethane Bush Kit- Shackle (V6 Model)	\$ 53.10
7	UBL-29	4	Rear U-Bolts	\$ 24.61
8	LGSKNSN-018	2	Rear Greasable Shackle Kit	\$ 96.30
9	LGPKNSN-003	2	Rear Greasable Pin Kit	\$ 60.19
10	64612097	2	Front Gas Legend Shock Absorber	\$ 227.70
11	64612636	2	Rear Gas Legend Shock Absorber	\$ 244.03

SUSPENSION KITS

Kit Type	Part No.	Qty. per vehicle	Kit Description	List Price EACH
B	NISSKIT001-B	1	RAISED	\$ 3,189.28
C	NISSKIT001-C	1	RAISED HEAVY DUTY	\$ 3,322.58

NISSAN- Navara
D22 Pick Up and Tray Back
4/97-11/05
Torsion Bar/Leaf

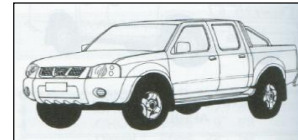

KIT COMPONENTS

Item	Part No.	Qty. per vehicle	Description	List Price EACH
1	NISS025	1 Pair	Front Heavy Duty Torsion Bars	\$ 660.33
2	NP-22	2	Rear Leaf Springs- Raised (B)	\$ 517.32
3	NP-22MS	2	Rear Leaf Springs- Raised Heavy Duty (C)	\$ 685.70
4	N71646	1	Rear Urethane Bush Kit- Spring Front eye	\$ 106.74
5	N71060	1	Rear Urethane Bush Kit- Spring Rear eye and Shackle	\$ 82.78
6	N71190	1	Rear Urethane Bush Kit- Shackle (V6 Model)	\$ 53.10
7	UBL-29	4	Rear U-Bolts	\$ 24.61
8	LGSKNSN-018	2	Rear Greasable Shackle Kit	\$ 96.30
9	LGPKNSN-003	2	Rear Greasable Pin Kit	\$ 60.19
10	64612854	2	Front Gas Legend Shock Absorber	\$ 273.31
11	64612636	2	Rear Gas Legend Shock Absorber	\$ 244.03

SUSPENSION KITS

Kit Type	Part No.	Qty. per vehicle	Kit Description	List Price EACH
B	NISSKIT002-B	1	RAISED	\$ 3,383.67
C	NISSKIT002-C	1	RAISED HEAVY DUTY	\$ 3,720.43

Part No.	Load Rating	Description
All spring load ratings are an approximate only. Vehicle ride heights will vary depending on load and accessories fitted.		
NP-11	0 to 100kg Constant Load	
NP-11HD	150 to 250kg Constant Load	
NP-22	0 to 100kg Constant Load	
NP-22MS	150 to 250kg Constant Load	

NISSAN- Navara
D40 Pick Up and Dual Cab (2.5 Diesel & 4.0 V6)
12/05-5/15
Coil/Leaf



KIT COMPONENTS

Item	Part No.	Qty. per vehicle	Description	List Price EACH
1	DFR-87	2	Front Coil Springs- Raised (B)	\$ 126.26
2	DFR-87HD	2	Front Coil Springs- Raised Heavy Duty (C)	\$ 132.42
3	NP-70	2	Rear Leaf Springs- Raised (B)	\$ 617.13
4	NP-70HD	2	Rear Leaf Springs- Raised Heavy Duty (C)	\$ 694.43
5	NP-70EHD	2	Rear Leaf Springs- Raised Extra Heavy Duty	\$ 845.70
6	N73250	1	Rear Urethane Bush Kit- Spring Front eye	\$ 116.38
7	N73251	1	Rear Urethane Bush Kit- Spring Rear eye	\$ 63.30
8	N73252	1	Rear Urethane Bush Kit- Spring Shackle	\$ 69.68
9	UBL-29	4	Rear U-Bolts	\$ 24.61
10	LGSK797-1	2	Rear Greasable Shackle Kit	\$ 96.30
11	LGPK387-2	2	Rear Pin Kit (Non Greasable)	\$ 47.08
12	64610010L	2	Front Gas Legend Strut	\$ 321.11
13	6462258N	2	Rear Gas Legend Shock Absorber	\$ 244.03

Note: Front STRUTS P/N 64610010L are supplied with a gold removable lower spring seat & a 10mm spacer tube. The spacer tube will raise the front height by an extra 15mm if required to compensate for extra weight only and to trim vehicle height. Lovells do not recommend using the spacer for Raised (B Kit) when steel bull and winch are fitted. Lovells do not recommend using the spacer with Raised Heavy Duty (C Kit) as this will void warranty.

SUSPENSION KITS

Kit Type	Part No.	Qty. per vehicle	Kit Description	List Price EACH
B	NISSKIT021-B	1	RAISED	\$ 3,251.62
C	NISSKIT021-C	1	RAISED HEAVY DUTY	\$ 3,418.53

ACCESSORIES (Not included in Kit)

Item	Part No.	Qty. per vehicle	Accessory Description	List Price EACH
1A	N23255	1	Front Urethane Kit- Sway Bar- Link Assembly	\$ 153.77
2A	N23323	1	Front Urethane Bush Kit- Sway Bar- Mount 32mm	\$ 42.23
3A	N33324	1	Front Urethane Bush Kit-Shock Absorber to Control Arm	\$ 95.55
4A	N53272	1	Front Urethane Bush Kit- Control Arm- Lower Inner STD	\$ 242.74
5A	N53273	1	Front Urethane Bush Kit- Control Arm- Lower Inner ADJ	\$ 195.07
6A	N53274	1	Front Urethane Bush Kit- Control Arm- Upper Inner	\$ 229.97

Part No.	Load Rating	Description
All spring load ratings are an approximate only. Vehicle ride heights will vary depending on load and accessories fitted.		
DFR-87	0 to 100kg Constant Load	Suits Steel Bull Bar
DFR-87HD	100 to 150kg Constant Load	Suits Steel Bull Bar, Winch, Underbody Protection etc.
NP-70	0 to 100kg Constant Load	
NP-70HD	150 to 250kg Constant Load	
NP-70EHD	400 to 500kg Constant Load	

NISSAN- Navara
D40 ST-X 550 Pick Up and Dual Cab (3.0 V6)
3/10-5/15
Coil/Leaf



KIT COMPONENTS

Item	Part No.	Qty. per vehicle	Description	List Price EACH
1	DFR-165	2	Front Coil Springs- Raised (B)	\$ 132.42
2	NP-70	2	Rear Leaf Springs- Raised (B)	\$ 617.13
3	N73250	1	Rear Urethane Bush Kit- Spring Front eye	\$ 116.38
4	N73251	1	Rear Urethane Bush Kit- Spring Rear eye	\$ 63.30
5	N73252	1	Rear Urethane Bush Kit- Spring Shackle	\$ 69.68
6	UBL-29	4	Rear U-Bolts	\$ 24.61
7	LGSK797-1	2	Rear Greasable Shackle Kit	\$ 96.30
8	LGPK387-2	2	Rear Pin Kit (Non Greasable)	\$ 47.08
9	64610010L	2	Front Gas Legend Strut	\$ 321.11
10	6462258N	2	Rear Gas Legend Shock Absorber	\$ 244.03

Note: Front STRUTS P/N 64610010L are supplied with a gold removable lower spring seat & a 10mm spacer tube. The spacer tube will raise the front height by an extra 15mm if required to compensate for extra weight only and to trim vehicle height. Lovells do not recommend using the spacer for Raised (B Kit) when steel bull and winch are fitted. Lovells do not recommend using the spacer with Raised Heavy Duty (C Kit) as this will void warranty.

SUSPENSION KITS

Kit Type	Part No.	Qty. per vehicle	Kit Description	List Price EACH
B	NISSKIT027-B	1	RAISED	\$ 3,263.94

Part No.	Load Rating	Description
All spring load ratings are an approximate only. Vehicle ride heights will vary depending on load and accessories fitted.		
DFR-165	0 to 100kg Constant Load	Suits Steel Bull Bar
NP-70	0 to 100kg Constant Load	

NISSAN-NAVARA
NP300 Pick Up
6/15 on
Coil/Leaf

KIT COMPONENTS

Item	Part No.	Qty. per vehicle	Description	List Price EACH
1	DFR-200	2	Front Coil Springs - Raised (B)	\$ 126.26
2	DFR-200HD	2	Front Coil Springs - Raised Heavy Duty (C)	\$ 126.26
3	NP-72	2	Rear Leaf Springs - Raised (B)	\$ 683.57
4	NP-72HD	2	Rear Leaf Springs - Raised Heavy Duty (C)	\$ 769.02
5	N73250	1	Rear Urethane Bush Kit - Spring Front Eye	\$ 116.38
6	N73251	1	Rear Urethane Bush Kit - Spring Rear Eye	\$ 63.30
7	N73251	1	Rear Urethane Bush Kit - Spring Shackle	\$ 63.30
8	UBL-18	4	Rear U-Bolts	\$ 24.61
9	LGSKNSN-021	2	Rear Greasable Shackle Kit	\$ 96.30
10	LGPK387-2	2	Rear Greasable Pin Kit	\$ 47.08
11	64611042	2	Front Gas Legend Strut	\$ 321.11
12	64611044	2	Rear Gas Legend Shock Absorber	\$ 244.03

SUSPENSION KITS

Kit Type	Part No.	Qty. per vehicle	Kit Description	List Price EACH
B	NISSKIT029-B	1	RAISED	\$ 3,378.13
C	NISSKIT029-C	1	RAISED HEAVY DUTY	\$ 3,551.40

Part No.	Load Rating	Description
All spring load ratings are an approximate only. Vehicle ride heights will vary depending on load and accessories fitted.		
DFR-200	0 to 100kg Constant Load	Suits Steel Bull Bar
DFR-200HD	100 to 150kg Constant Load	Suits Steel Bull Bar, Winch, Underbody Protection etc.
NP-72	0 to 100kg Constant Load	
NP-72HD	200 to 250kg Constant Load	

NISSAN- NAVARA
NP300 Pick Up
6/15 on
Coil/Coil

KIT COMPONENTS

Item	Part No.	Qty. per vehicle	Description	List Price EACH
1	DFR-200	2	Front Coil Springs - Raised (B)	\$ 126.26
2	DFR-200HD	2	Front Coil Springs - Raised Heavy Duty (C)	\$ 126.26
3	DRR-201	2	Rear Coil Springs - Raised (B)	\$ 126.26
4	DRR-201HD	2	Rear Coil Springs - Raised Heavy Duty (C)	\$ 126.26
5	64611042	2	Front Gas Legend Strut	\$ 321.11
6	64611043	2	Rear Gas Legend Shock Absorber	\$ 244.03

SUSPENSION KITS

Kit Type	Part No.	Qty. per vehicle	Kit Description	List Price EACH
B	NISSKIT028-B	1	RAISED	\$ 1,635.32
C	NISSKIT028-C	1	RAISED HEAVY DUTY	\$ 1,635.32

Part No.	Load Rating	Description
All spring load ratings are an approximate only. Vehicle ride heights will vary depending on load and accessories fitted.		
DFR-200	0 to 100kg Constant Load	Suits Steel Bull Bar
DFR-200HD	100 to 150kg Constant Load	Suits Steel Bull Bar, Winch, Underbody Protection etc.
DRR-201	0 to 100kg Constant Load	
DRR-201HD	150 to 250kg Constant Load	

NISSAN- Pathfinder
WD21 Wagon 4 door
2/88-8/92
Torsion Bar/Coil



KIT COMPONENTS

Item	Part No.	Qty. per vehicle	Description	List Price EACH
1	NISS017	1 Pair	Front Heavy Duty Torsion Bars	\$ 660.33
2	DRR-30	2	Rear Coil Springs- Raised (B)	\$ 126.26
3	DRR-30HD	2	Rear Coil Springs- Raised Heavy Duty (C)	\$ 126.26
4	DRR-30EHD	2	Rear Coil Springs- Raised Heavy Duty (C)	\$ 126.26
5	64612087	2	Front Gas Legend Shock Absorber	\$ 244.03
6	64612636	2	Rear Gas Legend Shock Absorber	\$ 244.03

SUSPENSION KITS

Kit Type	Part No.	Qty. per vehicle	Kit Description	List Price EACH
B	NISSKIT003-B	1	RAISED	\$ 1,888.95
C	NISSKIT003-C	1	RAISED HEAVY DUTY	\$ 1,888.95

NISSAN- Pathfinder
WD21 Wagon 4 door
9/92-10/95
Torsion Bar/Coil



KIT COMPONENTS

Item	Part No.	Qty. per vehicle	Description	List Price EACH
1	NISS017	1 Pair	Front Heavy Duty Torsion Bars	\$ 660.33
2	DRR-30	2	Rear Coil Springs- Standard Height (A)	\$ 126.26
3	DRR-30HD	2	Rear Coil Springs- Raised (B)	\$ 126.26
4	DRR-30EHD	2	Rear Coil Springs- Raised Heavy Duty (C)	\$ 126.26
5	64612087	2	Front Gas Legend Shock Absorber	\$ 244.03
6	64612636	2	Rear Gas Legend Shock Absorber	\$ 244.03

SUSPENSION KITS

Kit Type	Part No.	Qty. per vehicle	Kit Description	List Price EACH
A	NISSKIT004-A	1	STANDARD HEIGHT	\$ 1,888.95
B	NISSKIT004-B	1	RAISED	\$ 1,888.95
C	NISSKIT004-C	1	RAISED HEAVY DUTY	\$ 1,888.95

Part No.	Load Rating	Description
All spring load ratings are an approximate only. Vehicle ride heights will vary depending on load and accessories fitted.		
DRR-30	0 to 100kg Constant Load	
DRR-30HD	100 to 150kg Constant Load	
DRR-30EHD	150 to 250kg Constant Load	

NISSAN- Pathfinder
R50 Wagon 2 door (Terrano or Infinity QX4- EXPORT)
11/95-11/98
Coil/Coil

KIT COMPONENTS

Item	Part No.	Qty. per vehicle	Description	List Price EACH
1	DFS-84	2	Front Coil Springs- Standard Height (A)	\$ 126.26
2	DFR-84	2	Front Coil Springs- Raised (B)	\$ 126.26
3	DFR-84HD	2	Front Coil Springs- Raised Heavy Duty (C)	\$ 126.26
4	DRS-83	2	Rear Coil Springs- Standard Height (A)	\$ 126.26
5	DRR-83	2	Rear Coil Springs- Raised (B)	\$ 126.26
6	DRR-83HD	2	Rear Coil Springs- Raised Heavy Duty (C)	\$ 126.26
7	64611011	1	Front Gas Legend Strut- LEFT HAND	\$ 270.25
8	64611012	1	Front Gas Legend Strut- RIGHT HAND	\$ 270.25
9	6462525M (11/95-1/98 build date)	2	Rear Gas Legend Shock Absorber	\$ 270.25
10	6462525X (1/98-11/98 build date)	2	Rear Gas Legend Shock Absorber	\$ 235.00

Note: Please specify build date when ordering.

SUSPENSION KITS

Kit Type	Part No.	Qty. per vehicle	Kit Description	List Price EACH
A	NISSKIT005-A	1	STANDARD HEIGHT	\$ 1,586.04
B	NISSKIT005-B	1	RAISED	\$ 1,586.04
C	NISSKIT005-C	1	RAISED HEAVY DUTY	\$ 1,586.04

ACCESSORIES (Not included in Kit)

Item	Part No.	Qty. per vehicle	Accessory Description	List Price EACH
1A	N23255	1	Front Urethane Kit- Sway Bar- Link Assembly	\$ 153.77
2A	N53277	1	Front Urethane Bush Kit- Control Arm- Lower Inner STD	\$ 131.76
3A	N53278	1	Front Urethane Bush Kit- Control Arm- Lower Inner ADJ	\$ 203.50

Part No.	Load Rating	Description
All spring load ratings are an approximate only. Vehicle ride heights will vary depending on load and accessories fitted.		
DFS-84	0 to 100kg Constant Load	Suits Steel Bull Bar
DFR-84	0 to 100kg Constant Load	Suits Steel Bull Bar
DFR-84HD	100 to 150kg Constant Load	Suits Steel Bull Bar, Winch, Underbody Protection etc.
DRS-83	0 to 100kg Constant Load	
DRR-83	0 to 100kg Constant Load	
DRR-83HD	100 to 150kg Constant Load	

NISSAN- Pathfinder
R50 Wagon 4 door (Terrano or Infinity QX4- EXPORT)
11/95-11/98
Coil/Coil



KIT COMPONENTS

Item	Part No.	Qty. per vehicle	Description	List Price EACH
1	DFS-84	2	Front Coil Springs- Standard Height (A)	\$ 126.26
2	DFR-84	2	Front Coil Springs- Raised (B)	\$ 126.26
3	DFR-84HD	2	Front Coil Springs- Raised Heavy Duty (C)	\$ 126.26
4	DRR-83	2	Rear Coil Springs- Standard Height (A)	\$ 126.26
5	DRR-83HD	2	Rear Coil Springs- Raised (B)	\$ 126.26
6	DRR-83EHD	2	Rear Coil Springs- Raised Heavy Duty (C)	\$ 126.26
7	64611011	1	Front Gas Legend Strut- LEFT HAND	\$ 270.25
8	64611012	1	Front Gas Legend Strut- RIGHT HAND	\$ 270.25
9	6462525M (11/95-1/98 build date)	2	Rear Gas Legend Shock Absorber	\$ 270.25
10	6462525X (1/98-11/98 build date)	2	Rear Gas Legend Shock Absorber	\$ 270.25

Note: Please specify build date when ordering.

SUSPENSION KITS

Kit Type	Part No.	Qty. per vehicle	Kit Description	List Price EACH
A	NISSKIT006-A	1	STANDARD HEIGHT	\$ 1,586.04
B	NISSKIT006-B	1	RAISED	\$ 1,586.04
C	NISSKIT006-C	1	RAISED HEAVY DUTY	\$ 1,586.04

ACCESSORIES (Not included in Kit)

Item	Part No.	Qty. per vehicle	Accessory Description	List Price EACH
1A	N23255	1	Front Urethane Kit- Sway Bar- Link Assembly	\$ 153.77
2A	N53277	1	Front Urethane Bush Kit- Control Arm- Lower Inner STD	\$ 131.76
3A	N53278	1	Front Urethane Bush Kit- Control Arm- Lower Inner ADJ	\$ 203.50

Part No.	Load Rating	Description
All spring load ratings are an approximate only. Vehicle ride heights will vary depending on load and accessories fitted.		
DFS-84	0 to 100kg Constant Load	Suits Steel Bull Bar
DFR-84	0 to 100kg Constant Load	Suits Steel Bull Bar
DFR-84HD	100 to 150kg Constant Load	Suits Steel Bull Bar, Winch, Underbody Protection etc.
DRS-83	0 to 100kg Constant Load	
DRR-83	0 to 100kg Constant Load	
DRR-83HD	100 to 150kg Constant Load	
DRR-83EHD	150 to 250kg Constant Load	

NISSAN- Pathfinder
R50 Wagon (Terrano or Infinity QM4- EXPORT)
11/98-6/05
Coil/Coil



KIT COMPONENTS

Item	Part No.	Qty. per vehicle	Description	List Price EACH
1	DFS-84	2	Front Coil Springs- Standard Height (A)	\$ 126.26
2	DFR-84	2	Front Coil Springs- Raised (B)	\$ 126.26
3	DFR-84HD	2	Front Coil Springs- Raised Heavy Duty (C)	\$ 126.26
4	DRR-83	2	Rear Coil Springs- Standard Height (A)	\$ 126.26
5	DRR-83HD	2	Rear Coil Springs- Raised (B)	\$ 126.26
6	DRR-83EHD	2	Rear Coil Springs- Raised Heavy Duty (C)	\$ 126.26
7	64611013	1	NLA	\$ -
8	64611014	1	NLA	\$ -
9	6462525X	2	Rear Gas Legend Shock Absorber	\$ 270.25

SUSPENSION KITS

Kit Type	Part No.	Qty. per vehicle	Kit Description	List Price EACH
A	NISSKIT023-A	1	STANDARD HEIGHT	\$ 1,045.54
B	NISSKIT023-B	1	RAISED	\$ 1,045.54
C	NISSKIT023-C	1	RAISED HEAVY DUTY	\$ 1,045.54

Part No.	Load Rating	Description
All spring load ratings are an approximate only. Vehicle ride heights will vary depending on load and accessories fitted.		
DFS-84	0 to 100kg Constant Load	Suits Steel Bull Bar
DFR-84	0 to 100kg Constant Load	Suits Steel Bull Bar
DFR-84HD	100 to 150kg Constant Load	Suits Steel Bull Bar, Winch, Underbody Protection etc.
DRR-83	0 to 100kg Constant Load	
DRR-83HD	100 to 150kg Constant Load	
DRR-83EHD	150 to 250kg Constant Load	

NISSAN- Pathfinder (Terrano or Infinity QM- EXPORT)

R51 Wagon

07/05 on

Coil/Coil

KIT COMPONENTS

Item	Part No.	Qty. per vehicle	Description	List Price EACH
1	DFS-88	2	Front Coil Springs- Standard Height (A)	\$ 126.26
2	DFR-88	2	Front Coil Springs- Raised (B)	\$ 126.26
3	DFR-88HD	2	Front Coil Springs- Raised Heavy Duty (C)	\$ 126.26
4	DRS-89	2	Rear Coil Springs- Standard Height (A)	\$ 144.58
5	DRR-89	2	Rear Coil Springs- Raised (B)	\$ 144.58
6	DRR-89HD	2	Rear Coil Springs- Raised Heavy Duty (C)	\$ 161.27
7	64610010L	2	Front Gas Legend Strut	\$ 321.11
8	64611017	2	Rear Gas Legend Shock Absorber	\$ 244.03

SUSPENSION KITS

Kit Type	Part No.	Qty. per vehicle	Kit Description	List Price EACH
A	NISSKIT024-A	1	STANDARD HEIGHT	\$ 1,671.97
B	NISSKIT024-B	1	RAISED	\$ 1,671.97
C	NISSKIT024-C	1	RAISED HEAVY DUTY	\$ 1,705.33

ACCESSORIES (Not included in Kit)

Item	Part No.	Qty. per vehicle	Accessory Description	List Price EACH
1A	N23255	1	Front Urethane Kit- Sway Bar- Link Assembly	\$ 153.77
2A	N53272	1	Front Urethane Bush Kit- Control Arm- Lower Inner STD	\$ 242.74
3A	N53273	1	Front Urethane Bush Kit- Control Arm- Lower Inner ADJ	\$ 195.07
4A	N93232	1	Front Urethane Bush Kit- Differential Mount	TBA
5A	N63218	1	Rear Urethane Bush Kit- Control Arm- Lower	\$ 249.27
6A	N63219	1	Rear Urethane Bush Kit- Control Arm- Upper	\$ 238.41

Part No.	Load Rating	Description
All spring load ratings are an approximate only. Vehicle ride heights will vary depending on load and accessories fitted.		
DFS-88	0 to 100kg Constant Load	Suits Steel Bull Bar
DFR-88	0 to 100kg Constant Load	Suits Steel Bull Bar
DFR-88HD	100 to 150kg Constant Load	Suits Steel Bull Bar, Winch, Underbody Protection etc.
DRS-89	0 to 100kg Constant Load	
DRR-89	0 to 100kg Constant Load	
DRR-89HD	100 to 150kg Constant Load	

NISSAN- Patrol
MQ Wagon SWB and LWB
6/80-3/83
Leaf/Leaf



KIT COMPONENTS

Item	Part No.	Qty. per vehicle	Description	List Price EACH
1	NP-3	2	Front Leaf Springs- Raised (B)	\$ 408.31
2	NP-3HD	2	Front Leaf Springs- Raised Heavy Duty (C)	\$ 487.15
3	NP-6	2	Rear Leaf Springs- Raised (B)	\$ 685.71
4	NP-6HD	2	Rear Leaf Springs- Raised Heavy Duty (C)	\$ 685.70
5	N/A	1	Front Urethane Bush Kit- Spring Front eye	
6	N71101	1	Front Urethane Bush Kit- Spring Rear eye	\$ 61.38
7	N/A	1	Front Urethane Bush Kit- Spring Shackle	
8	N71101	1	Rear Urethane Bush Kit- Spring Front eye	\$ 61.38
9	N71085	1	Rear Urethane Bush Kit- Spring Rear eye	\$ 50.52
10	N71098	1	Rear Urethane Bush Kit- Spring Shackle	\$ 58.63
11	UBL-02	2	Front Driver Side U-Bolt	\$ 24.61
12	UBL-01	2	Front Passenger Side U-Bolts	\$ 24.61
13	UBL-03	4	Rear U-Bolts	\$ 24.61
14	LGSK355K	2	Front Greasable Shackle	\$ 96.30
15	LGPK470	2	Front Greasable Pin	\$ 47.08
16	LGSK664	2	Rear Greasable Shackle	\$ 96.30
17	LGPK470	2	Rear Greasable Pin	\$ 47.08
18	64612077	2	Front Gas Legend Shock Absorber	\$ 227.70
19	64612076	2	Rear Gas Legend Shock Absorber	\$ 244.03

SUSPENSION KITS

Kit Type	Part No.	Qty. per vehicle	Kit Description	List Price EACH
B	NISSKIT007-B	1	RAISED	\$ 4,133.81
C	NISSKIT007-C	1	RAISED HEAVY DUTY	\$ 4,291.49

ACCESSORIES (Not included in Kit)

Item	Part No.	Qty. per vehicle	Accessory Description	List Price EACH
1A	N31207	1	Front Urethane Bush Kit- Shock Absorber	\$ 52.86
2A	N12105	1	Front Urethane Bush Kit- Steering Idler	\$ 27.08
3A	N21064	1	Front Urethane Bush Kit- Sway Bar Link	\$ 43.30
4A	N21139	1	Front Urethane Bush Kit- Sway Bar Mount	\$ 37.33
5A	N31469	1	Rear Urethane Bush Kit- Shock Absorber Upper	\$ 31.19
6A	N21172	1	Rear Urethane Bush Kit- Shock Absorber Lower	\$ 31.65

STEERING DAMPERS (Not included in Kit)

Item	Part No.	Qty. per vehicle	Description	List Price EACH
1B	5450009	1	Steering Damper Assembly- Heavy Duty	\$ 161.74
2B	5450009-RTC	1	Steering Damper Assembly- Return to Centre	\$ 202.68

Part No.	Load Rating	Description
All spring load ratings are an approximate only. Vehicle ride heights will vary depending on load and accessories fitted.		
NP-3	0 to 100kg Constant Load	Suits Steel Bull Bar
NP-3HD	150 to 250kg Constant Load	Suits Steel Bull Bar, Winch, Underbody Protection etc.
NP-6	0 to 100kg Constant Load	
NP-6HD	150 to 250kg Constant Load	

NISSAN- Patrol
MQ Trayback (Petrol)
6/80-3/83
Leaf/Leaf

KIT COMPONENTS

Item	Part No.	Qty. per vehicle	Description	List Price EACH
1	NP-3	2	Front Leaf Springs- Raised (B)	\$ 408.31
2	NP-3HD	2	Front Leaf Springs- Raised Heavy Duty (C)	\$ 487.15
3	NP-6	2	Rear Leaf Springs- Raised (B)	\$ 685.71
4	NP-6HD	2	Rear Leaf Springs- Raised Heavy Duty (C)	\$ 685.70
5	N71101	1	Front Urethane Bush Kit- Spring Rear eye	\$ 61.38
6	N71101	1	Rear Urethane Bush Kit- Spring Front eye	\$ 61.38
7	N71085	1	Rear Urethane Bush Kit- Spring Rear eye	\$ 50.52
8	N71098	1	Rear Urethane Bush Kit- Spring Shackle	\$ 58.63
9	UBL-02	2	Front Driver Side U-Bolt	\$ 24.61
10	UBL-01	2	Front Passenger Side U-Bolts	\$ 24.61
11	UBL-03	4	Rear U-Bolts	\$ 24.61
12	LGSK355K	2	Front Greasable Shackle	\$ 96.30
13	LGPK470	2	Front Greasable Pin	\$ 47.08
14	LGSK664	2	Rear Greasable Shackle	\$ 96.30
15	LGPK470	2	Rear Greasable Pin	\$ 47.08
16	64612077	2	Front Gas Legend Shock Absorber	\$ 227.70
17	64612076	2	Rear Gas Legend Shock Absorber	\$ 244.03

SUSPENSION KITS

Kit Type	Part No.	Qty. per vehicle	Kit Description	List Price EACH
B	NISSKIT008-B	1	RAISED	\$ 4,133.81
C	NISSKIT008-C	1	RAISED HEAVY DUTY	\$ 4,291.49

ACCESSORIES (Not included in Kit)

Item	Part No.	Qty. per vehicle	Accessory Description	List Price EACH
1A	N31207	1	Front Urethane Bush Kit- Shock Absorber	\$ 52.86
2A	N12105	1	Front Urethane Bush Kit- Steering Idler	\$ 27.08
3A	N21064	1	Front Urethane Bush Kit- Sway Bar Link	\$ 43.30
4A	N21139	1	Front Urethane Bush Kit- Sway Bar Mount	\$ 37.33
5A	N31469	1	Rear Urethane Bush Kit- Shock Absorber Upper	\$ 31.19
6A	N21172	1	Rear Urethane Bush Kit- Shock Absorber Lower	\$ 31.65

STEERING DAMPERS (Not included in Kit)

Item	Part No.	Qty. per vehicle	Description	List Price EACH
1B	5450009	1	Steering Damper Assembly- Heavy Duty	\$ 161.74
2B	5450009-RTC	1	Steering Damper Assembly- Return to Centre	\$ 202.68

Part No.	Load Rating	Description
All spring load ratings are an approximate only. Vehicle ride heights will vary depending on load and accessories fitted.		
NP-3	0 to 100kg Constant Load	Suits Steel Bull Bar
NP-3HD	150 to 250kg Constant Load	Suits Steel Bull Bar, Winch, Underbody Protection etc.
NP-6	0 to 100kg Constant Load	
NP-6HD	150 to 250kg Constant Load	

NISSAN- Patrol
MQ Trayback (Diesel)
6/80-3/83
Leaf/Leaf

KIT COMPONENTS

Item	Part No.	Qty. per vehicle	Description	List Price EACH
1	NP-5	2	Front Leaf Springs- Raised (B)	\$ 440.88
2	NP-5HD	2	Front Leaf Springs- Raised Heavy Duty (C)	\$ 487.15
3	NP-6	2	Rear Leaf Springs- Raised (B)	\$ 685.71
4	NP-6HD	2	Rear Leaf Springs- Raised Heavy Duty (C)	\$ 685.70
5	N71101	1	Front Urethane Bush Kit- Spring Rear eye	\$ 61.38
6	N71101	1	Rear Urethane Bush Kit- Spring Front eye	\$ 61.38
7	N71085	1	Rear Urethane Bush Kit- Spring Rear eye	\$ 50.52
8	N71098	1	Rear Urethane Bush Kit- Spring Shackle	\$ 58.63
9	UBL-02	2	Front Driver Side U-Bolt	\$ 24.61
10	UBL-01	2	Front Passenger Side U-Bolts	\$ 24.61
11	UBL-03	4	Rear U-Bolts	\$ 24.61
12	LGSK355K	2	Front Greasable Shackle	\$ 96.30
13	LGPK470	2	Front Greasable Pin	\$ 47.08
14	LGSK664	2	Rear Greasable Shackle	\$ 96.30
15	LGPK470	2	Rear Greasable Pin	\$ 47.08
16	64612077	2	Front Gas Legend Shock Absorber	\$ 227.70
17	64612076	2	Rear Gas Legend Shock Absorber	\$ 244.03

SUSPENSION KITS

Kit Type	Part No.	Qty. per vehicle	Kit Description	List Price EACH
B	NISSKIT009-B	1	RAISED	\$ 4,198.96
C	NISSKIT009-C	1	RAISED HEAVY DUTY	\$ 4,291.48

ACCESSORIES (Not included in Kit)

Item	Part No.	Qty. per vehicle	Accessory Description	List Price EACH
1A	N31207	1	Front Urethane Bush Kit- Shock Absorber	\$ 52.86
2A	N12105	1	Front Urethane Bush Kit- Steering Idler	\$ 27.08
3A	N21064	1	Front Urethane Bush Kit- Sway Bar Link	\$ 43.30
4A	N21139	1	Front Urethane Bush Kit- Sway Bar Mount	\$ 37.33
5A	N31469	1	Rear Urethane Bush Kit- Shock Absorber Upper	\$ 31.19
6A	N21172	1	Rear Urethane Bush Kit- Shock Absorber Lower	\$ 31.65

STEERING DAMPERS (Not included in Kit)

Item	Part No.	Qty. per vehicle	Description	List Price EACH
1B	5450009	1	Steering Damper Assembly- Heavy Duty	\$ 161.74
2B	5450009-RTC	1	Steering Damper Assembly- Return to Centre	\$ 202.68

Part No.	Load Rating	Description
All spring load ratings are an approximate only. Vehicle ride heights will vary depending on load and accessories fitted.		
NP-5	0 to 100kg Constant Load	Suits Steel Bull Bar
NP-5HD	100 to 150kg Constant Load	Suits Steel Bull Bar, Winch, Underbody Protection etc.
NP-6	0 to 100kg Constant Load	
NP-6HD	150 to 250kg Constant Load	

NISSAN- Patrol
MK Wagon SWB and LWB (Petrol)
3/83-87
Leaf/Leaf



KIT COMPONENTS

Item	Part No.	Qty. per vehicle	Description	List Price EACH
1	NP-7	2	Front Leaf Springs- Raised (B)	\$ 438.53
2	NP-7HD	2	Front Leaf Springs- Raised Heavy Duty (C)	\$ 487.15
3	NP-10	2	Rear Leaf Springs- Raised (B)	\$ 687.58
4	NP-10HD	2	Rear Leaf Springs- Raised Heavy Duty (C)	\$ 781.42
5	N71101	1	Front Urethane Bush Kit- Spring Rear eye	\$ 61.38
6	N71101	1	Rear Urethane Bush Kit- Spring Front eye	\$ 61.38
7	N71085	1	Rear Urethane Bush Kit- Spring Rear eye	\$ 50.52
8	N71098	1	Rear Urethane Bush Kit- Spring Shackle	\$ 58.63
9	UBL-02	2	Front Driver Side U-Bolt	\$ 24.61
10	UBL-01	2	Front Passenger Side U-Bolts	\$ 24.61
11	UBL-03	4	Rear U-Bolts	\$ 24.61
12	LGSK665	2	Front Greasable Shackle	\$ 96.30
13	LGPK470	2	Front Greasable Pin	\$ 47.08
14	LGSK664	2	Rear Greasable Shackle	\$ 96.30
15	LGPK470	2	Rear Greasable Pin	\$ 47.08
16	64612077	2	Front Gas Legend Shock Absorber	\$ 227.70
17	64612076	2	Rear Gas Legend Shock Absorber	\$ 244.03

SUSPENSION KITS

Kit Type	Part No.	Qty. per vehicle	Kit Description	List Price EACH
B	NISSKIT010-B	1	RAISED	\$ 4,198.00
C	NISSKIT010-C	1	RAISED HEAVY DUTY	\$ 4,482.92

ACCESSORIES (Not included in Kit)

Item	Part No.	Qty. per vehicle	Accessory Description	List Price EACH
1A	N31207	1	Front Urethane Bush Kit- Shock Absorber	\$ 52.86
2A	N21064	1	Front Urethane Bush Kit- Sway Bar Link	\$ 43.30
3A	N21139	1	Front Urethane Bush Kit- Sway Bar Mount	\$ 37.33
4A	N31469	1	Rear Urethane Bush Kit- Shock Absorber Upper	\$ 31.19
5A	N21172	1	Rear Urethane Bush Kit- Shock Absorber Lower	\$ 31.65

Part No.	Load Rating	Description
All spring load ratings are an approximate only. Vehicle ride heights will vary depending on load and accessories fitted.		
NP-7	0 to 100kg Constant Load	Suits Steel Bull Bar
NP-7HD	100 to 150kg Constant Load	Suits Steel Bull Bar, Winch, Underbody Protection etc.
NP-10	0 to 100kg Constant Load	
NP-10HD	150 to 250kg Constant Load	

NISSAN- Patrol
MK Wagon SWB and LWB (Diesel)
3/83-87
Leaf/Leaf

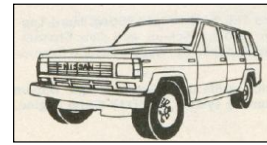

KIT COMPONENTS

Item	Part No.	Qty. per vehicle	Description	List Price EACH
1	NP-8	2	Front Leaf Springs- Raised (B)	\$ 449.56
2	NP-8HD	2	Front Leaf Springs- Raised Heavy Duty (C)	\$ 566.16
3	NP-10	2	Rear Leaf Springs- Raised (B)	\$ 587.58
4	NP-10HD	2	Rear Leaf Springs- Raised Heavy Duty (C)	\$ 781.42
5	N71101	1	Front Urethane Bush Kit- Spring Rear eye	\$ 61.38
6	N71101	1	Rear Urethane Bush Kit- Spring Front eye	\$ 61.38
7	N71085	1	Rear Urethane Bush Kit- Spring Rear eye	\$ 50.52
8	N71098	1	Rear Urethane Bush Kit- Spring Shackle	\$ 58.63
9	UBL-02	2	Front Driver Side U-Bolt	\$ 24.61
10	UBL-01	2	Front Passenger Side U-Bolts	\$ 24.61
11	UBL-03	4	Rear U-Bolts	\$ 24.61
12	LGSK665	2	Front Greasable Shackle	\$ 96.30
13	LGPK470	2	Front Greasable Pin	\$ 47.08
14	LGSK664	2	Rear Greasable Shackle	\$ 96.30
15	LGPK470	2	Rear Greasable Pin	\$ 47.08
16	64612077	2	Front Gas Legend Shock Absorber	\$ 227.70
17	64612076	2	Rear Gas Legend Shock Absorber	\$ 244.03

SUSPENSION KITS

Kit Type	Part No.	Qty. per vehicle	Kit Description	List Price EACH
B	NISSKIT011-B	1	RAISED	\$ 4,020.05
C	NISSKIT011-C	1	RAISED HEAVY DUTY	\$ 4,640.93

ACCESSORIES (Not included in Kit)

Item	Part No.	Qty. per vehicle	Accessory Description	List Price EACH
1A	N31207	1	Front Urethane Bush Kit- Shock Absorber	\$ 52.86
2A	N21064	1	Front Urethane Bush Kit- Sway Bar Link	\$ 43.30
3A	N21139	1	Front Urethane Bush Kit- Sway Bar Mount	\$ 37.33
4A	N31469	1	Rear Urethane Bush Kit- Shock Absorber Upper	\$ 31.19
5A	N21172	1	Rear Urethane Bush Kit- Shock Absorber Lower	\$ 31.65

Part No.	Load Rating	Description
All spring load ratings are an approximate only. Vehicle ride heights will vary depending on load and accessories fitted.		
NP-8	0 to 100kg Constant Load	Suits Steel Bull Bar
NP-8HD	100 to 150kg Constant Load	Suits Steel Bull Bar, Winch, Underbody Protection etc.
NP-10	0 to 100kg Constant Load	
NP-10HD	150 to 250kg Constant Load	

NISSAN- Patrol
GQ Wagon SWB
2/88-12/97
Coil/Coil

KIT COMPONENTS

Item	Part No.	Qty. per vehicle	Description	List Price EACH
1	DFS-31	2	Front Coil Springs- Standard Height (A)	\$ 118.00
2	DFR-31	2	Front Coil Springs- Raised (B)	\$ 126.26
3	DFS-41	2	Front Coil Springs- Raised Heavy Duty (C)	\$ 126.26
4	DRS-33	2	Rear Coil Springs- Standard Height (A)	\$ 141.02
5	DRR-33	2	Rear Coil Springs- Raised (B)	\$ 141.02
6	DRS-42	2	Rear Coil Springs- Raised Heavy Duty (C)	\$ 194.64
7	64612491	2	Front Gas Legend Shock Absorber	\$ 272.97
8	6462525N	2	Rear Gas Legend Shock Absorber	\$ 244.03

SUSPENSION KITS

Kit Type	Part No.	Qty. per vehicle	Kit Description	List Price EACH
A	NISSKIT012-A	1	STANDARD HEIGHT	\$ 1,552.03
B	NISSKIT012-B	1	RAISED	\$ 1,568.55
C	NISSKIT012-C	1	RAISED HEAVY DUTY	\$ 1,675.79

ACCESSORIES (Not included in Kit)

Item	Part No.	Qty. per vehicle	Accessory Description	List Price EACH
1A	N81730	1	Front Urethane Bush Kit- Adjust. Caster Bush	\$ 297.55
2A	LPR004	1	Front Adjustable Panhard Rod Assembly	\$ 491.15
3A	LPR004LHD	1	Front Adjustable Panhard Rod Assembly- LH DRIVE	\$ 491.15
4A	N81429	1	Front Urethane Bush Kit- Rad. Arm to Chassis	\$ 84.08
5A	N23254	1	Front Urethane Bush Kit- Sway Bar- Link Assbly	\$ 153.30
6A	LPR005	1	Rear Adjustable Panhard Rod Assembly	\$ 491.15
7A	N63044	1	Rear Lower Trailing Arm Assembly	\$ 508.43
8A	N62870	1	Rear Upper Trailing Arm Assembly- Adjustable	\$ 449.35
9A	N23254	1	Rear Urethane Bush Kit- Sway Bar- Link Assbly	\$ 153.30
10A	646GQGBS	1	Gearbox Spacer Kit	\$ 200.00

Highlighted Accessories: Lovells strongly recommend fitting these accessories when using

Raised OR Raised Heavy Duty coil springs.

Note: If drive line vibration occurs use gearbox spacer kit 646GQGBS.

STEERING DAMPERS (Not included in Kit)

Item	Part No.	Qty. per vehicle	Description	List Price EACH
1B	5450007	1	Steering Damper Assembly- Heavy Duty	\$ 161.74
Steering Damper P/N suits 2/88-8/89 build dates				
2B	5450008	1	Steering Damper Assembly- Heavy Duty	\$ 161.74
3B	5450008-RTC	1	Steering Damper Assembly- Return to Centre	\$ 202.68
Steering Damper P/N suits 8/89-10/97 build dates				

Part No.	Load Rating	Description
All spring load ratings are an approximate only. Vehicle ride heights will vary depending on load and accessories fitted.		
DFS-31	0 to 100kg Constant Load	Suits Steel Bull Bar
DFR-31	0 to 100kg Constant Load	Suits Steel Bull Bar
DFS-41	100 to 150kg Constant Load	Suits Steel Bull Bar, Winch, Underbody Protection etc.
DRS-33	0 to 100kg Constant Load	
DRR-33	0 to 100kg Constant Load	
DRS-42	100 to 150kg Constant Load	

NISSAN- Patrol
GQ Wagon LWB
2/88-12/97
Coil/Coil



KIT COMPONENTS

Item	Part No.	Qty. per vehicle	Description	List Price EACH
1	DFS-41	2	Front Coil Springs- Standard Height (A)	\$ 126.26
2	DFR-41	2	Front Coil Springs- Raised (B)	\$ 126.26
3	DFR-41HD	2	Front Coil Springs- Raised Heavy Duty (C)	\$ 126.26
4	DRS-42	2	Rear Coil Springs- Standard Height (A)	\$ 194.64
5	DRR-42	2	Rear Coil Springs- Raised (B)	\$ 194.64
6	DRR-42HD	2	Rear Coil Springs- Raised Heavy Duty (C)	\$ 211.30
7	64612491	2	Front Gas Legend Shock Absorber	\$ 272.97
8	64612492-N	2	Rear Gas Legend Shock Absorber	\$ 244.03
Note: Extra Long Travel Front Gas Legend Shock Absorber available P/N 64612541 (\$244.02 each) Suits Hi Lift Applications where lift exceeds 75mm-100mm (3" - 4")				
Note: Extra Long Travel Rear Gas Legend Shock Absorber available P/N 64612848 (\$273.30 each) Suits Hi Lift Applications where lift exceeds 75mm-100mm (3" - 4")				

SUSPENSION KITS

Kit Type	Part No.	Qty. per vehicle	Kit Description	List Price EACH
A	NISSKIT013-A	1	STANDARD HEIGHT	\$ 1,675.79
B	NISSKIT013-B	1	RAISED	\$ 1,675.79
C	NISSKIT013-C	1	RAISED HEAVY DUTY	\$ 1,709.11

ACCESSORIES (Not included in Kit)

Item	Part No.	Qty. per vehicle	Accessory Description	List Price EACH
1A	N81730	1	Front Urethane Bush Kit- Adjust. Caster Bush	\$ 297.55
2A	LPR004	1	Front Adjustable Panhard Rod Assembly	\$ 491.15
3A	LPR004LHD	1	Front Adjustable Panhard Rod Assembly- LH DRIVE	\$ 491.15
4A	N81429	1	Front Urethane Bush Kit- Rad. Arm to Chassis	\$ 84.08
5A	N23254	1	Front Urethane Bush Kit- Sway Bar- Link Assbly	\$ 153.30
6A	LPR005	1	Rear Adjustable Panhard Rod Assembly	\$ 491.15
7A	N63044	1	Rear Lower Trailing Arm Assembly	\$ 508.43
8A	N62870	1	Rear Upper Trailing Arm Assembly- Adjustable	\$ 449.35
9A	N23254	1	Rear Urethane Bush Kit- Sway Bar- Link Assbly	\$ 153.30

Highlighted Accessories: Lovells strongly recommend fitting these accessories when using

Raised OR Raised Heavy Duty coil springs.

STEERING DAMPERS (Not included in Kit)

Item	Part No.	Qty. per vehicle	Description	List Price EACH
1B	5450007	1	Steering Damper Assembly- Heavy Duty	\$ 161.74
Steering Damper P/N suits 2/88-8/89 build dates				
2B	5450008	1	Steering Damper Assembly- Heavy Duty	\$ 161.74
3B	5450008-RTC	1	Steering Damper Assembly- Return to Centre	\$ 202.68
Steering Damper P/N suits 8/89-10/97 build dates				

Part No.	Load Rating	Description
All spring load ratings are an approximate only. Vehicle ride heights will vary depending on load and accessories fitted.		
DFS-41	0 to 100kg Constant Load	Suits Steel Bull Bar
DFR-41	0 to 100kg Constant Load	Suits Steel Bull Bar
DFR-41HD	100 to 150kg Constant Load	Suits Steel Bull Bar, Winch, Underbody Protection etc.
DRS-42	0 to 100kg Constant Load	
DRR-42	0 to 100kg Constant Load	
DRR-42HD	150 to 250kg Constant Load	

NISSAN- Patrol
GQ Tray Back
2/88-12/97
Leaf/Leaf

KIT COMPONENTS

Item	Part No.	Qty. per vehicle	Description	List Price EACH
1	NP-13	2	Front Leaf Springs- Raised (B)	\$ 515.73
2	NP-13HD	2	Front Leaf Springs- Raised Heavy Duty (C)	\$ 595.53
3	NP-12	2	Rear Leaf Springs- Raised (B)	\$ 1,319.12
4	NP-12HD	2	Rear Leaf Springs- Raised Heavy Duty (C)	\$ 1,435.57
5	N71708	1	Front Urethane Kit- Spring Front/Rear eyes/Shackle	\$ 179.45
6	N71042	1	Rear Urethane Kit- Spring Front/Rear eyes/Shackle	\$ 129.88
7	UBL-33	2	Front Driver Side U-Bolts	\$ 39.38
8	UBL-32	2	Front Passenger Side U-Bolts	\$ 24.61
9	UBL-15	4	Rear U-Bolts	\$ 24.61
10	LGSKGASP001 L/H	1	Front Greasable Shackle Kit- Anti Inversion	\$ 90.00
11	LGSKGASP001 R/H	1	Front Greasable Shackle Kit- Anti Inversion	\$ 90.00
12	LGPK667	2	Front Greasable Pin Kit	\$ 47.08
13	LGSKGASP001 L/H	1	Rear Greasable Shackle Kit- Anti Inversion	\$ 90.00
14	LGSKGASP001 R/H	1	Rear Greasable Shackle Kit- Anti Inversion	\$ 90.00
15	LGPK667	2	Rear Greasable Pin Kit	\$ 47.08
16	6462526B	2	Front Gas Legend Shock Absorber	\$ 227.70
17	6462525P	2	Rear Gas Legend Shock Absorber	\$ 272.82

SUSPENSION KITS

Kit Type	Part No.	Qty. per vehicle	Kit Description	List Price EACH
B	NISSKIT014-B	1	RAISED	\$ 5,754.80
C	NISSKIT014-C	1	RAISED HEAVY DUTY	\$ 6,147.30

ACCESSORIES (Not included in Kit)

Item	Part No.	Qty. per vehicle	Accessory Description	List Price EACH
1A	N21172	1	Front Urethane Bush Kit- Shock Absorber Lower	\$ 31.65
2A	N21228	1	Rear Urethane Bush Kit- Sway Bar Mount	\$ 37.33
3A	N21793	1	Rear Urethane Bush Kit- Shock Absorber Upper	\$ 44.42
4A	N21172	1	Rear Urethane Bush Kit- Shock Absorber Lower	\$ 31.65

Note: Above spring Part Numbers suit alloy tray fitment only. For steel tray Part Numbers please contact Lovells Springs.

STEERING DAMPERS (Not included in Kit)

Item	Part No.	Qty. per vehicle	Description	List Price EACH
1B	5450009	1	Steering Damper Assembly- Heavy Duty	\$ 161.74
2B	5450009-RTC	1	Steering Damper Assembly- Return to Centre	\$ 202.68

Part No.	Load Rating	Description
All spring load ratings are an approximate only. Vehicle ride heights will vary depending on load and accessories fitted.		
NP-13	0 to 100kg Constant Load	Suits Steel Bull Bar
NP-13HD	150 to 250kg Constant Load	Suits Steel Bull Bar, Winch, Underbody Protection etc.
NP-12	0 to 100kg Constant Load	
NP-12HD	150 to 250kg Constant Load	

NISSAN- Patrol
GQ Tray Back
2/88-12/97
Coil/Leaf

KIT COMPONENTS

Item	Part No.	Qty. per vehicle	Description	List Price EACH
1	DFS-41	2	Front Coil Springs- Standard Height (A)	\$ 126.26
2	DFR-41	2	Front Coil Springs- Raised (B)	\$ 126.26
3	DFR-41HD	2	Front Coil Springs- Raised Heavy Duty (C)	\$ 126.26
4	NP-12	2	Rear Leaf Springs- Standard Height (A)	\$ 1,319.12
5	NP-12MD	2	Rear Leaf Springs- Raised (B)	\$ 1,078.51
6	NP-12HD	2	Rear Leaf Springs- Raised Heavy Duty (C)	\$ 1,435.57
7	N71042	1	Rear Urethane Kit- Spring Front/Rear eyes/Shackle	\$ 129.88
8	UBL-15	4	Rear U-Bolts	\$ 24.61
9	LGSKGASP001 L/H	1	Rear Greasable Shackle Kit- Anti Inversion	\$ 90.00
10	LGSKGASP001 R/H	1	Rear Greasable Shackle Kit- Anti Inversion	\$ 90.00
11	LGPK667	2	Rear Greasable Pin Kit	\$ 47.08
12	64612491	2	Front Gas Legend Shock Absorber	\$ 272.97
13	6462525P	2	Rear Gas Legend Shock Absorber	\$ 272.82

SUSPENSION KITS

Kit Type	Part No.	Qty. per vehicle	Kit Description	List Price EACH
A	NISSKIT015-A	1	STANDARD HEIGHT	\$ 4,484.83
B	NISSKIT015-B	1	RAISED	\$ 4,003.61
C	NISSKIT015-C	1	RAISED HEAVY DUTY	\$ 4,717.73

ACCESSORIES (Not included in Kit)

Item	Part No.	Qty. per vehicle	Accessory Description	List Price EACH
1A	N81730	1	Front Urethane Bush Kit- Adjust. Caster Bush	\$ 297.55
2A	LPR004	1	Front Adjustable Panhard Rod Assembly	\$ 491.15
3A	LPR004LHD	1	Front Adjustable Panhard Rod Assembly- LH DRIVE	\$ 491.15
4A	N81429	1	Front Urethane Bush Kit- Rad. Arm to Chassis	\$ 84.08
5A	N21793	2	Front Urethane Bush Kit- Shock Absorber	\$ 44.42
6A	N31435	1	Front Urethane Bush Kit- Shock Absorber	\$ 59.85

Highlighted Accessories: Lovells strongly recommend fitting these accessories when using Raised OR Raised Heavy Duty coil springs.

STEERING DAMPERS (Not included in Kit)

Item	Part No.	Qty. per vehicle	Description	List Price EACH
1B	5450007	1	Steering Damper Assembly- Heavy Duty	\$ 161.74
Steering Damper P/N suits 2/88-8/89 build dates				
2B	5450008	1	Steering Damper Assembly- Heavy Duty	\$ 161.74
3B	5450008-RTC	1	Steering Damper Assembly- Return to Centre	\$ 202.68

Steering Damper P/N suits 8/89-10/97 build dates

Part No.	Load Rating	Description
All spring load ratings are an approximate only. Vehicle ride heights will vary depending on load and accessories fitted.		
DFS-41	0 to 100kg Constant Load	Suits Steel Bull Bar
DFR-41	0 to 100kg Constant Load	Suits Steel Bull Bar
DFR-41HD	100 to 150kg Constant Load	Suits Steel Bull Bar, Winch, Underbody Protection etc.
NP-12	0 to 100kg Constant Load	
NP-12MD	0 to 100kg Constant Load	
NP-12HD	150 to 250kg Constant Load	

NISSAN- Patrol

GQ Tray Back

2/88-12/97

Coil/Coil

KIT COMPONENTS

Item	Part No.	Qty. per vehicle	Description	List Price EACH
1	DFS-41	2	Front Coil Springs- Standard Height (A)	\$ 126.26
2	DFR-41	2	Front Coil Springs- Raised (B)	\$ 126.26
3	DFR-41HD	2	Front Coil Springs- Raised Heavy Duty (C)	\$ 126.26
4	DRS-42	2	Rear Coil Springs- Standard Height (A)	\$ 194.64
5	DRR-49	2	Rear Coil Springs- Raised (B)	\$ 199.19
6	DRR-49HD	2	Rear Coil Springs- Raised Heavy Duty (C)	\$ 211.28
7	64612491	2	Front Gas Legend Shock Absorber	\$ 272.97
8	64612492-N	2	Rear Gas Legend Shock Absorber	\$ 244.03

Note: Extra Long Travel Front Gas Legend Shock Absorber available P/N 64612541 (\$244.02 each)

Suits Hi Lift Applications where lift exceeds 75mm-100mm (3" - 4")

Note: Extra Long Travel Rear Gas Legend Shock Absorber available P/N 64612848 (\$273.30 each)

Suits Hi Lift Applications where lift exceeds 75mm-100mm (3" - 4")

SUSPENSION KITS

Kit Type	Part No.	Qty. per vehicle	Kit Description	List Price EACH
A	NISSKIT016-A	1	STANDARD HEIGHT	\$ 1,675.79
B	NISSKIT016-B	1	RAISED	\$ 1,684.89
C	NISSKIT016-C	1	RAISED HEAVY DUTY	\$ 1,709.07

ACCESSORIES (Not included in Kit)

Item	Part No.	Qty. per vehicle	Accessory Description	List Price EACH
1A	N81730	1	Front Urethane Bush Kit- Adjust. Caster Bush	\$ 297.00
2A	LPR004	1	Front Adjustable Panhard Rod Assembly	\$ 491.15
3A	LPR004LHD	1	Front Adjustable Panhard Rod Assembly- LH DRIVE	\$ 491.15
4A	N81429	1	Front Urethane Bush Kit- Rad. Arm to Chassis	\$ 84.08
5A	N23254	1	Front Urethane Bush Kit- Sway Bar- Link Assbly	\$ 153.30
6A	LPR005	1	Rear Adjustable Panhard Rod Assembly	\$ 491.15
7A	N63044	1	Rear Lower Trailing Arm Assembly	\$ 508.43
8A	N62870	1	Rear Upper Trailing Arm Assembly- Adjustable	\$ 449.35
9A	N23254	1	Rear Urethane Bush Kit- Sway Bar- Link Assbly	\$ 153.30

STEERING DAMPERS (Not included in Kit)

Item	Part No.	Qty. per vehicle	Description	List Price EACH
1B	5450007	1	Steering Damper Assembly- Heavy Duty	\$ 161.74
Steering Damper P/N suits 2/88-8/89 build dates				
2B	5450008	1	Steering Damper Assembly- Heavy Duty	\$ 161.74
3B	5450008-RTC	1	Steering Damper Assembly- Return to Centre	\$ 202.68
Steering Damper P/N suits 8/89-10/97 build dates				

Part No.	Load Rating	Description
All spring load ratings are an approximate only. Vehicle ride heights will vary depending on load and accessories fitted.		
DFS-41	0 to 100kg Constant Load	Suits Steel Bull Bar
DFR-41	0 to 100kg Constant Load	Suits Steel Bull Bar
DFR-41HD	100 to 150kg Constant Load	Suits Steel Bull Bar, Winch, Underbody Protection etc.
DRS-42	0 to 100kg Constant Load	
DRR-49	0 to 100kg Constant Load	
DRR-49HD	150 to 250kg Constant Load	

NISSAN- Patrol
Y61 GU Wagon LWB
11/97 on



Coil/Coil

Progressive Rate Coil Spring OPTION

KIT COMPONENTS

Item	Part No.	Qty. per vehicle	Description	List Price EACH
1	DFR-41LTO	2	Front Coil Springs- Raised	\$ 139.00
2	DRR-42LTO	2	Rear Coil Springs- Raised	\$ 177.95
3	64612541	2	Front Gas Legend Shock Absorber	\$ 244.03
4	64612848	2	Rear Gas Legend Shock Absorber	\$ 273.31

SUSPENSION KITS

Kit Type	Part No.	Qty. per vehicle	Kit Description	List Price EACH
B	NISSKIT025-B	1	RAISED	\$ 1,668.57

ACCESSORIES (Not included in Kit)

Item	Part No.	Qty. per vehicle	Accessory Description	List Price EACH
1A	N81730	1	Front Urethane Bush Kit- Adjust. Caster Bush	\$ 297.55
2A	LPR004	1	Front Adjustable Panhard Rod Assembly	\$ 491.15
3A	LPR004LHD	1	Front Adjustable Panhard Rod Assembly- LH DRIVE	\$ 491.15
(11/97-2/03 build date)				
4A	LPR028	1	Front Adjustable Panhard Rod Assembly	\$ 491.15
5A	N81429	1	Front Urethane Bush Kit- Rad. Arm to Chassis	\$ 84.08
6A	N21793	2	Front Urethane Bush Kit- Shock Absorber	\$ 44.42
7A	CH0001	1	Front ABS Spacer - 25mm	\$ 29.41
8A	LPR005	1	Rear Adjustable Panhard Rod Assembly	\$ 491.15
(11/97-2/03 build date)				
9A	LPR029		Rear Adjustable Panhard Rod Assembly	\$ 491.15
(2/03 on build date)				
10A	N31435	1	Front Urethane Bush Kit- Shock Absorber	\$ 59.85
11A012A	N63044	1	Rear Lower Trailing Arm Assembly	\$ 508.43
13A	N62870	1	Rear Upper Trailing Arm Assembly- Adjustable	\$ 449.35

Highlighted Accessories: Lovells strongly recommend fitting these accessories when using Raised OR Raised Heavy Duty coil springs. ***ITEM 8A- Refer Page 80 for Tech Bulletin***

STEERING DAMPERS (Not included in Kit)

Item	Part No.	Qty. per vehicle	Description	List Price EACH
1B	5450004	1	Steering Damper Assembly- Heavy Duty	\$ 161.74
2B	5450004-RTC	1	Steering Damper Assembly- Return to Centre	\$ 202.68
Steering Damper P/N suits 11/97-1/00 build dates				
3B	5450006	1	Steering Damper Assembly- Heavy Duty	\$ 161.74
4B	5450006-RTC	1	Steering Damper Assembly- Return to Centre	\$ 189.75

Steering Damper P/N suits 2/00 on build dates

Part No.	Load Rating	Description
All spring load ratings are an approximate only. Vehicle ride heights will vary depending on load and accessories fitted.		
DFR-41LTO	0 to 100kg Constant Load	Suits Steel Bull Bar
DRR-42LTO	0 to 100kg Constant Load	

NISSAN- Patrol
Y61 GU Wagon LWB
11/97 on



Coil/Coil

Linear Rate Coil Spring OPTION

KIT COMPONENTS

Item	Part No.	Qty. per vehicle	Description	List Price EACH
1	DFS-41	2	Front Coil Springs- Standard Height (A)	\$ 126.26
2	DFR-41	2	Front Coil Springs- Raised (B)	\$ 126.26
3	DFR-41HD	2	Front Coil Springs- Raised Heavy Duty (C)	\$ 126.26
4	DRS-42	2	Rear Coil Springs- Standard Height (A)	\$ 194.64
5	DRR-42	2	Rear Coil Springs- Raised (B)	\$ 194.64
6	DRR-42HD	2	Rear Coil Springs- Raised Heavy Duty (C)	\$ 211.30
7	64612491	2	Front Gas Legend Shock Absorber	\$ 272.97
8	64612492-N	2	Rear Gas Legend Shock Absorber	\$ 244.03

Note: Extra Long Travel Front Gas Legend Shock Absorber available P/N 64612541 (\$244.02 each)

Suits Hi Lift Applications where lift exceeds 75mm-100mm (3" - 4")

Note: Extra Long Travel Rear Gas Legend Shock Absorber available P/N 64612848 (\$273.30 each)

Suits Hi Lift Applications where lift exceeds 75mm-100mm (3" - 4")

SUSPENSION KITS

Kit Type	Part No.	Qty. per vehicle	Kit Description	List Price EACH
A	NISSKIT017-A	1	STANDARD HEIGHT	\$ 1,675.79
B	NISSKIT017-B	1	RAISED	\$ 1,675.79
C	NISSKIT017-C	1	RAISED HEAVY DUTY	\$ 1,709.11

ACCESSORIES (Not included in Kit)

Item	Part No.	Qty. per vehicle	Description	List Price EACH
1A	N81730	1	Front Urethane Bush Kit- Adjust. Caster Bush	\$ 297.55
2A	LPR004	1	Front Adjustable Panhard Rod Assembly	\$ 491.15
3A	LPR004LHD	1	Front Adjustable Panhard Rod Assembly- LH DRIVE	\$ 491.15
(11/97-2/03 build date)				
4A	LPR028	1	Front Adjustable Panhard Rod Assembly	\$ 491.15
5A	N81429	1	Front Urethane Bush Kit- Rad. Arm to Chassis	\$ 84.08
6A	CH0001	1	Front ABS Spacer - 25mm	\$ 29.41
7A	LPR005	1	Rear Adjustable Panhard Rod Assembly	\$ 491.15
(11/97-2/03 build date)				
8A	LPR029		Rear Adjustable Panhard Rod Assembly	\$ 491.15
(2/03 on build date)				
9A	N63044	1	Rear Lower Trailing Arm Assembly	\$ 508.43
10A	N62870	1	Rear Upper Trailing Arm Assembly- Adjustable	\$ 449.35

STEERING DAMPERS (Not included in Kit)

Item	Part No.	Qty. per vehicle	Description	List Price EACH
1B	5450004	1	Steering Damper Assembly- Heavy Duty	\$ 161.74
2B	5450004-RTC	1	Steering Damper Assembly- Return to Centre	\$ 202.68
Steering Damper P/N suits 11/97-1/00 build dates				
3B	5450006	1	Steering Damper Assembly- Heavy Duty	\$ 161.74
4B	5450006-RTC	1	Steering Damper Assembly- Return to Centre	\$ 189.75
Steering Damper P/N suits 2/00 on build dates				

Part No.	Load Rating	Description
All spring load ratings are an approximate only. Vehicle ride heights will vary depending on load and accessories fitted.		
DFS-41	0 to 100kg Constant Load	Suits Steel Bull Bar
DFR-41	0 to 100kg Constant Load	Suits Steel Bull Bar
DFR-41HD	100 to 150kg Constant Load	Suits Steel Bull Bar, Winch, Underbody Protection etc.
DRS-42	0 to 100kg Constant Load	
DRR-42	0 to 100kg Constant Load	
DRR-42HD	150 to 250kg Constant Load	

NISSAN- Patrol
Y61 GU Wagon LWB
11/97 on



Coil/Coil

KIT COMPONENTS

Item	Part No.	Qty. per vehicle	Description	SOLD AS KIT ONLY
1	NPGU-001	2	Front Coil Springs- Platinum	
2	NPGU-002	2	Rear Coil Springs- Platinum	
3	64612541	2	Front Gas Legend Shock Absorber	
4	64612848	2	Rear Gas Legend Shock Absorber	
5	N81730	1	Front Urethane Bush Kit- Adjust. Caster Bush	
6	LPR004 (11/97-2/03 build date)	1	Front Adjustable Panhard Rod Assembly	
6	LPR028 (2/03 on build date)	1	Front Adjustable Panhard Rod Assembly	
7	LPR005 (11/97-2/03 build date)	1	Rear Adjustable Panhard Rod Assembly	
7	LPR029 (2/03 on build date)		Rear Adjustable Panhard Rod Assembly	
8	CH0001	1	Front ABS Spacer - 25mm	

SUSPENSION KITS

Kit Type	Part No.	Qty. per vehicle	Kit Description	List Price EACH
Plat	NISSKIT022-Plat	1	PLATINUM SERIES KIT	\$ 3,350.00

*******Lifetime Warranty on Platinum Series Coil Springs*******

Lovells Platinum Series

Lovells Platinum Series Coil Springs are Computer designed and manufactured from centerless ground X4K Premium Onesteel Bar. All coil springs are individually sonically crack tested and are coated in a high gloss Platinum Powder for long life. The Platinum Series Kit is designed for constant load applications, ideally suited for expedition and long haul adventurers.

Lovells Platinum Series Kits have been trialled and tested by several high profile Tag Along 4x4 Tour Operators over several years and thousands of arduous kilometers. Lifetime unlimited km warranty on Platinum Series coil springs to the original retail purchaser.

ITEM 8- Refer Page 114 for Tech Bulletin

STEERING DAMPERS (Not included in Kit)

Item	Part No.	Qty. per vehicle	Description	List Price EACH
1B	5450004	1	Steering Damper Assembly- Heavy Duty	\$ 161.74
2B	5450004-RTC	1	Steering Damper Assembly- Return to Centre	\$ 202.68
Steering Damper P/N suits 11/97-1/00 build dates				
3B	5450006	1	Steering Damper Assembly- Heavy Duty	\$ 161.74
4B	5450006-RTC	1	Steering Damper Assembly- Return to Centre	\$ 189.75
Steering Damper P/N suits 2/00 on build dates				

Part No.	Load Rating	Description
All spring load ratings are an approximate only. Vehicle ride heights will vary depending on load and accessories fitted.		
NPGU-001	100 to 150kg Constant Load	Suits Steel Bull Bar, Winch, Underbody Protection etc.
NPGU-002	150 to 250kg Constant Load	

NISSAN- Patrol
Y61 GU Tray Back
4/99 on
Coil/Coil

KIT COMPONENTS

Item	Part No.	Qty. per vehicle	Description	List Price EACH
1	DFR-41LTO	2	Front Coil Springs- Raised (B)	\$ 126.26
2	DFR-41HD	2	Front Coil Springs- Raised Heavy Duty (C)	\$ 126.26
3	DRR-49LTO	2	Rear Coil Springs- Raised (B)	\$ 211.30
4	DRR-49HD	2	Rear Coil Springs- Raised Heavy Duty (C)	\$ 211.28
5	64612491	2	Front Gas Legend Shock Absorber	\$ 272.97
6	64612492-N	2	Rear Gas Legend Shock Absorber	\$ 244.03

Note: Extra Long Travel Front Gas Legend Shock Absorber available P/N 64612541 (\$244.02 each)

Suits Hi Lift Applications where lift exceeds 75mm-100mm (3" - 4")

Note: Extra Long Travel Rear Gas Legend Shock Absorber available P/N 64612848 (\$273.30 each)

Suits Hi Lift Applications where lift exceeds 75mm-100mm (3" - 4")

SUSPENSION KITS

Kit Type	Part No.	Qty. per vehicle	Kit Description	List Price EACH
B	NISSKIT018-B	1	RAISED	\$ 1,709.11
C	NISSKIT018-C	1	RAISED HEAVY DUTY	\$ 1,709.07

ACCESSORIES (Not included in Kit)

Item	Part No.	Qty. per vehicle	Accessory Description	List Price EACH
1A	N81730	1	Front Urethane Bush Kit- Adjust. Caster Bush	\$ 297.55
2A	LPR004	1	Front Adjustable Panhard Rod Assembly	\$ 491.15
3A	LPR004LHD	1	Front Adjustable Panhard Rod Assembly- LH DRIVE	\$ 491.15
(11/97-2/03 build date)				
4A	LPR028	1	Front Adjustable Panhard Rod Assembly	\$ 491.15
5A	N81429	1	Front Urethane Bush Kit- Rad. Arm to Chassis	\$ 84.08
6A	CH0001	1	Front ABS Spacer - 25mm	\$ 29.41
7A	LPR005	1	Rear Adjustable Panhard Rod Assembly	\$ 491.15
(11/97-2/03 build date)				
8A	LPR029		Rear Adjustable Panhard Rod Assembly	\$ 491.15
9A	(2/03 on build date)			
10A	N63044	1	Rear Lower Trailing Arm Assembly	\$ 508.43
11A	N62870	1	Rear Upper Trailing Arm Assembly- Adjustable	\$ 449.35

Highlighted Accessories: Lovells strongly recommend fitting these accessories when using

Raised OR Raised Heavy Duty coil springs. ***ITEM 8A- Refer Page 80 for Tech Bulletin***

STEERING DAMPERS (Not included in Kit)

Item	Part No.	Qty. per vehicle	Description	List Price EACH
1B	5450006	1	Steering Damper Assembly- Heavy Duty	\$ 161.74
2B	5450006-RTC	1	Steering Damper Assembly- Return to Centre	\$ 189.75

Steering Damper P/N suits 2/00 on build dates

Part No.	Load Rating	Description
All spring load ratings are an approximate only. Vehicle ride heights will vary depending on load and accessories fitted.		
DFR-41LTO	0 to 100kg Constant Load	Suits Steel Bull Bar
DFR-41HD	100 to 150kg Constant Load	Suits Steel Bull Bar, Winch, Underbody Protection etc.
DRR-49LTO	0 to 100kg Constant Load	
DRR-49HD	150 to 250kg Constant Load	

NISSAN- Patrol
Y61 GU Tray Back
4/99 on
Coil/Leaf

KIT COMPONENTS

Item	Part No.	Qty. per vehicle	Description	List Price EACH
1	DFR-41	2	Front Coil Springs- Raised (B)	\$ 126.26
2	DFR-41HD	2	Front Coil Springs- Raised Heavy Duty (C)	\$ 126.26
3	NP-61	2	Rear Leaf Springs- Raised (B)	\$ 1,248.06
4	NP-61HD	2	Rear Leaf Springs- Raised Heavy Duty (C)	\$ 1,371.40
5	N71042	1	Rear Urethane Kit- Spring Front/Rear eyes/Shackle	\$ 129.88
6	UBL-36	4	Rear U-Bolts	\$ 39.38
7	LGSKGASP001 L/H	1	Rear Greasable Shackle Kit- Anti Inversion	\$ 90.00
8	LGSKGASP001 R/H	1	Rear Greasable Shackle Kit- Anti Inversion	\$ 90.00
9	LGPK667	2	Rear Greasable Pin Kit	\$ 47.08
10	64612491	2	Front Gas Legend Shock Absorber	\$ 272.97
11	6462525P	2	Rear Gas Legend Shock Absorber	\$ 272.82

SUSPENSION KITS

Kit Type	Part No.	Qty. per vehicle	Kit Description	List Price EACH
B	NISSKIT019-B	1	RAISED	\$ 4,401.77
C	NISSKIT019-C	1	RAISED HEAVY DUTY	\$ 4,648.45

ACCESSORIES (Not included in Kit)

Item	Part No.	Qty. per vehicle	Accessory Description	List Price EACH
1A	N81730	1	Front Urethane Bush Kit- Adjust. Caster Bush	\$ 297.55
2A	LPR004	1	Front Adjustable Panhard Rod Assembly	\$ 491.15
3A	LPR004LHD	1	Front Adjustable Panhard Rod Assembly- LH DRIVE	\$ 491.15
(11/97-2/03 build date)				
4A	LPR028	1	Front Adjustable Panhard Rod Assembly	\$ 491.15
5A	N81429	1	Front Urethane Bush Kit- Rad. Arm to Chassis	\$ 84.08
6A	CH0001	1	Front ABS Spacer - 25mm	\$ 29.41

Highlighted Accessories: Lovells strongly recommend fitting these accessories when using Raised OR Raised Heavy Duty coil springs. ***ITEM 9A- Refer Page 80 for Tech Bulletin***

STEERING DAMPERS (Not included in Kit)

Item	Part No.	Qty. per vehicle	Description	List Price EACH
1B	5450006	1	Steering Damper Assembly- Heavy Duty	\$ 161.74
2B	5450006-RTC	1	Steering Damper Assembly- Return to Centre	\$ 189.75

Steering Damper P/N suits 2/00 on build dates

Part No.	Load Rating	Description
All spring load ratings are an approximate only. Vehicle ride heights will vary depending on load and accessories fitted.		
DFR-41	0 to 100kg Constant Load	Suits Steel Bull Bar
DFR-41HD	100 to 150kg Constant Load	Suits Steel Bull Bar, Winch, Underbody Protection etc.
NP-61	0 to 100kg Constant Load	
NP-61HD	150 to 250kg Constant Load	

NISSAN- Patrol
Y61 GU 5 Tray Back - DX 3.0 Litre
3/07 on
Coil/Leaf

GVM Upgrade Kit (Fitted Price)-State Compliance

KIT COMPONENTS

Item	Part No.	Qty. per vehicle	Description	SOLD AS KIT ONLY
1	DFS-41	2	Front Coil Springs- GVM UPGRADE (GVM)	
2	NP-61	2	Rear Leaf Springs- GVM UPGRADE (GVM)	
3	N71042	1	Rear Urethane Kit- Spring Front/Rear eyes/Shackle	
4	UBL-36	4	Rear U-Bolts	
5	LGSKGASP001 L/H	1	Rear Greasable Shackle Kit- Anti Inversion	
6	LGSKGASP001 R/H	1	Rear Greasable Shackle Kit- Anti Inversion	
7	LGPK667	2	Rear Greasable Pin Kit	
8	64612491	2	Front Gas Legend Shock Absorber	
9	6462525P	2	Rear Gas Legend Shock Absorber	
10	N81730	1	Front Urethane Bush Kit- Adjust. Caster Bush	
11	CH0001	1	Front ABS Spacer - 25mm	
12	77ACMB-LCRUISER-GVM-IND	2	Category 6 Indicators ADR 13/00	
13		1	3900kg Compliance Plate	
14		1	Proportioning Valve Adjustment Warning Decal	
15		1	3900kg Tyre Loading Placard (Decal)	
16		1	GVM Upgrade Fitting Instructions	

SUSPENSION KITS

Kit Type	Part No.	Qty. per vehicle	Kit Description	Retail Price
GVM	NISSKIT020-GVM	1	GVM Upgrade Kit (Fitted Price)	\$ 4,809.00

NOTE: Fitted Price plus GST

Part No.	Load Rating	Description
All spring load ratings are an approximate only. Vehicle ride heights will vary depending on load and accessories fitted.		
DFS-41	0 to 100kg Constant Load	Suits Steel Bull Bar
NP-61	0 to 100kg Constant Load	To GVM

*****NOTE: The above GVM Upgrade Kit for Federal Compliance under Second Stage Manufacturer Approval, with a Federal compliance plate, is no longer available. The above kit can still be supplied under State Compliance and will require inspection, by a Lovells endorsed signatory and /or Production Facility. Consult your nearest Lovells Production facility for Individual State requirements.**

TECHNICAL BULLETIN P/N CH0001 – Front ABS Spacer

Subject: NISSAN PATROL GU FRONT LONG TRAVEL SUSPENSION

Lovells Springs Pty Ltd publish this information in order to maintain safety standards and to assist in correct application and performance of Lovells products.

The Nissan GU Patrol (Y61) is available with ABS brakes. This system employs an additional brake hose to the front left side of the axle housing. In its standard form, the hose will be stretched, if long travel shock absorbers are fitted.

A simple kit has been developed that raises the mounting point of the flexible brake hose coupling sufficiently to allow safe fitment of long travel shock absorbers.

The part number for this kit is CH0001 and it consists of a 25mm spacer, a M8 x 1.25 x 55mm bolt, a spring washer and fitting instruction as shown.

Lovells strongly recommend that this spacer be Fitted when using Raised or Raised Heavy Duty Coil Springs and Lovells Gas Legend Shock Absorbers.



Standard Installation



CH0001 Fitted

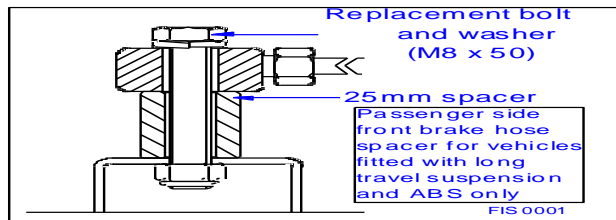

NISSAN- Patrol
Y62 Wagon LWB
2012 on
Coil/Coil

KIT COMPONENTS

Item	Part No.	Qty. per vehicle	Description	List Price EACH
1	DFS-98	2	Front Coil Springs- Standard Height (A)	\$ 144.45
2	DFR-98	2	Front Coil Springs- Raised (B)	\$ 144.45
3	DFR-98HD	2	Front Coil Springs- Raised Heavy Duty (C)	\$ 144.45
4	DRS-99	2	Rear Coil Springs- Standard Height (A)	\$ 192.67
5	DRR-99	2	Rear Coil Springs- Raised (B)	\$ 199.14
6	DRR-99HD	2	Rear Coil Springs- Raised Heavy Duty (C)	\$ 215.82
7	64611035	2	Front Gas Legend Strut	\$ 321.11
8	64611036	2	Rear Gas Legend Shock Absorber	\$ 244.03

SUSPENSION KITS

Kit Type	Part No.	Qty. per vehicle	Kit Description	List Price EACH
A	NISSKIT026-A	1	STANDARD HEIGHT	\$ 1,804.52
B	NISSKIT026-B	1	RAISED	\$ 1,817.47
C	NISSKIT026-C	1	RAISED HEAVY DUTY	\$ 1,850.83

Part No.	Load Rating	Description
All spring load ratings are an approximate only. Vehicle ride heights will vary depending on load and accessories fitted.		
DFS-98	0 to 100kg Constant Load	Suits Steel Bull Bar
DFR-98	0 to 100kg Constant Load	Suits Steel Bull Bar
DFR-98HD	100 to 150kg Constant Load	Suits Steel Bull Bar, Winch, Underbody Protection etc.
DRS-99	0 to 100kg Constant Load	
DRR-99	0 to 100kg Constant Load	
DRR-99HD	100 to 150kg Constant Load	

NISSAN- Terrano II
R20 Wagon
3/97-4/00
Torsion Bar/Coil



KIT COMPONENTS

Item	Part No.	Qty. per vehicle	Description	List Price EACH
1	NISS017	1 Pair	Front Heavy Duty Torsion Bars	\$ 660.33
2	DRR-30	2	Rear Coil Springs- Raised (B)	\$ 126.26
3	DRR-30HD	2	Rear Coil Springs- Raised Heavy Duty (C)	\$ 126.26
4	64612463	2	NLA	\$ -
5	64612636	2	Rear Gas Legend Shock Absorber	\$ 244.03

Note: Extra Heavy Duty Coil Springs available for R20 Wagon P/N DRR-30EHD (\$94.50 each)

SUSPENSION KITS

Kit Type	Part No.	Qty. per vehicle	Kit Description	List Price EACH
B	NISSKIT022-B	1	RAISED	\$ 1,400.91
C	NISSKIT022-C	1	RAISED HEAVY DUTY	\$ 1,400.91

Part No.	Load Rating	Description
All spring load ratings are an approximate only. Vehicle ride heights will vary depending on load and accessories fitted.		
DRR-30	0 to 100kg Constant Load	
DRR-30HD	100 to 150kg Constant Load	

Ssangyong
Musso- Wagon
8/96-2002
Torsion Bar/Coil

KIT COMPONENTS

Item	Part No.	Qty. per vehicle	Description	List Price EACH
1	SSANG001	1 Pair	Front Heavy Duty Torsion Bars	\$ 605.30
2	SRR-100	2	Rear Coil Springs- Raised (B)	\$ 118.00
3	6462543S	2	Front Gas Legend Shock Absorber	\$ 244.03
4	64612091E	2	Rear Gas Legend Shock Absorber	\$ 244.03

SUSPENSION KITS

Kit Type	Part No.	Qty. per vehicle	Kit Description	List Price EACH
B	SSANGKIT001-B	1	RAISED	\$ 1,817.40

Part No.	Load Rating	Description
All spring load ratings are an approximate only. Vehicle ride heights will vary depending on load and accessories fitted.		
SRR-100	0 to 100kg Constant Load	

SUZUKI- Jimny
SN413-JB33 Wagon
10/98-2017
Coil/Coil



KIT COMPONENTS

Item	Part No.	Qty. per vehicle	Description	List Price EACH
1	SFS-80	2	Front Coil Springs- Standard Height (A)	\$ 111.28
2	SFR-80	2	Front Coil Springs- Raised (B)	\$ 111.28
3	SRS-81	2	Rear Coil Springs- Standard Height (A)	\$ 111.28
4	SRR-81	2	Rear Coil Springs- Raised (B)	\$ 111.28
5	64612639D	2	Front Gas Legend Shock Absorber	\$ 244.03
6	6460015C	2	Rear Gas Legend Shock Absorber	\$ 244.03

SUSPENSION KITS

Kit Type	Part No.	Qty. per vehicle	Kit Description	List Price EACH
A	SUZKIT001-A	1	STANDARD HEIGHT	\$ 1,421.22
B	SUZKIT001-B	1	RAISED	\$ 1,421.22

Lovells strongly recommend fitting a good quality front caster kit when using SUZKIT001-B
Caution: When using SUZKIT001-A, springs can become non-captive at full droop

Part No.	Load Rating	Description
All spring load ratings are an approximate only. Vehicle ride heights will vary depending on load and accessories fitted.		
SFS-80	0 to 100kg Constant Load	Suits Steel Bull Bar
SFR-80	0 to 100kg Constant Load	Suits Steel Bull Bar
SRS-81	0 to 100kg Constant Load	
SRR-81	0 to 100kg Constant Load	

SUZUKI- Sierra
SJ40 Soft Top and Hard Top
7/81-7/88
Leaf/Leaf



KIT COMPONENTS

Item	Part No.	Qty. per vehicle	Description	List Price EACH
1	SK-5	2	Front Leaf Springs- Raised (B)	\$ 179.93
2	SK-5HD	2	Front Leaf Springs- Raised Heavy Duty (C)	\$ 222.73
3	SK-6	2	Rear Leaf Springs- Raised (B)	\$ 262.10
4	SK-6HD	2	Rear Leaf Springs- Raised Heavy Duty (C)	\$ 352.80
5	N71456	1	Front Urethane Bush Kit- Spring Front eyes/shackle	\$ 85.90
6	N71455	1	Front Urethane Bush Kit- Spring Rear eyes	\$ 91.21
7	N71456	1	Rear Urethane Bush Kit- Spring Rear eyes/shackle	\$ 85.90
8	N71455	1	Rear Urethane Bush Kit- Spring Front eyes	\$ 91.21
9	UBL-21	2	Front Driver Side U-Bolt	\$ 24.61
10	UBL-22	2	Front Passenger Side U-Bolt	\$ 24.61
11	UBL-22	4	Rear U-Bolts	\$ 24.61
12	LSK656	2	Front Shackle (non-greasable)	\$ 47.94
13	LPK657	2	Front Pin (non-greasable)	\$ 42.80
14	LSK656	2	Rear Shackle (non-greasable)	\$ 47.94
15	LPK657	2	Rear Pin (non-greasable)	\$ 42.80
16	64612639D	2	Front Gas Legend Shock Absorber	\$ 244.03
17	64612111	2	Rear Gas Legend Shock Absorber	\$ 244.03

SUSPENSION KITS

Kit Type	Part No.	Qty. per vehicle	Kit Description	List Price EACH
B	SUZKIT002-B	1	RAISED	\$ 2,774.21
C	SUZKIT002-C	1	RAISED HEAVY DUTY	\$ 3,041.21

ACCESSORIES (Not included in Kit)

Item	Part No.	Qty. per vehicle	Accessory Description	List Price EACH
1A	N31062	1	Front Urethane Bush Kit- Shock Absorber Lower	\$ 25.77
2A	N31469	1	Rear Urethane Bush Kit- Shock Absorber Upper/Lower	\$ 31.19

Part No.	Load Rating	Description
All spring load ratings are an approximate only. Vehicle ride heights will vary depending on load and accessories fitted.		
SFS-80	0 to 100kg Constant Load	Suits Steel Bull Bar
SFR-80	0 to 100kg Constant Load	Suits Steel Bull Bar
SRS-81	0 to 100kg Constant Load	
SRR-81	0 to 100kg Constant Load	

SUZUKI- Sierra
SJ40 Tray Back
7/81-7/88
Leaf/Leaf

KIT COMPONENTS

Item	Part No.	Qty. per vehicle	Description	List Price EACH
1	SK-5	2	Front Leaf Springs- Raised (B)	\$ 179.93
2	SK-5HD	2	Front Leaf Springs- Raised Heavy Duty (C)	\$ 222.73
3	SK-8	2	Rear Leaf Springs- Raised (B)	\$ 263.98
4	SK-8HD	2	Rear Leaf Springs- Raised Heavy Duty (C)	\$ 323.93
5	N71456	1	Front Urethane Bush Kit- Spring Front eyes/shackle	\$ 85.90
6	N71455	1	Front Urethane Bush Kit- Spring Rear eyes	\$ 91.21
7	N71456	1	Rear Urethane Bush Kit- Spring Rear eyes/shackle	\$ 85.90
8	N71455	1	Rear Urethane Bush Kit- Spring Front eyes	\$ 91.21
9	UBL-21	2	Front Driver Side U-Bolt	\$ 24.61
10	UBL-22	2	Front Passenger Side U-Bolt	\$ 24.61
11	UBL-22	4	Rear U-Bolts	\$ 24.61
12	LSK656	2	Front Shackle (non-greasable)	\$ 47.94
13	LPK657	2	Front Pin (non-greasable)	\$ 42.80
14	LSK656	2	Rear Shackle (non-greasable)	\$ 47.94
15	LPK657	2	Rear Pin (non-greasable)	\$ 42.80
16	64612639D	2	Front Gas Legend Shock Absorber	\$ 244.03
17	64612111	2	Rear Gas Legend Shock Absorber	\$ 244.03

SUSPENSION KITS

Kit Type	Part No.	Qty. per vehicle	Kit Description	List Price EACH
B	SUZKIT003-B	1	RAISED	\$ 2,777.97
C	SUZKIT003-C	1	RAISED HEAVY DUTY	\$ 2,983.47

ACCESSORIES (Not included in Kit)

Item	Part No.	Qty. per vehicle	Accessory Description	List Price EACH
1A	N31062	1	Front Urethane Bush Kit- Shock Absorber Lower	\$ 25.77
2A	N31469	1	Rear Urethane Bush Kit- Shock Absorber Upper/Lower	\$ 31.19

Part No.	Load Rating	Description
All spring load ratings are an approximate only. Vehicle ride heights will vary depending on load and accessories fitted.		
SK-5	0 to 60kg Constant Load	Suits Alloy Bull Bar
SK-5HD	60 to 120kg Constant Load	Suits Steel Bull Bar
SK-8	0 to 100kg Constant Load	
SK-8HD	60 to 120kg Constant Load	

SUZUKI- Sierra (Samurai -EXPORT)
SJ50, SJ413 Soft Top and Hard Top
10/84-3/96
Leaf/Leaf



KIT COMPONENTS

Item	Part No.	Qty. per vehicle	Description	List Price EACH
1	SK-7	2	Front Leaf Springs- Raised (B)	\$ 179.93
2	SK-7HD	2	Front Leaf Springs- Raised Heavy Duty (C)	\$ 222.68
3	SK-8	2	Rear Leaf Springs- Raised (B)	\$ 263.98
4	SK-8HD	2	Rear Leaf Springs- Raised Heavy Duty (C)	\$ 323.93
5	N71456	1	Front Urethane Bush Kit- Spring Front eyes/shackle	\$ 85.90
6	N71455	1	Front Urethane Bush Kit- Spring Rear eyes	\$ 91.21
7	N71456	1	Rear Urethane Bush Kit- Spring Rear eyes/shackle	\$ 85.90
8	N71455	1	Rear Urethane Bush Kit- Spring Front eyes	\$ 91.21
9	UBL-21	2	Front Driver Side U-Bolt	\$ 24.61
10	UBL-22	2	Front Passenger Side U-Bolt	\$ 24.61
11	UBL-22	4	Rear U-Bolts	\$ 24.61
12	LSK656	2	Front Shackle (non-greasable)	\$ 47.94
13	LPK657	2	Front Pin (non-greasable)	\$ 42.80
14	LSK656	2	Rear Shackle (non-greasable)	\$ 47.94
15	LPK657	2	Rear Pin (non-greasable)	\$ 42.80
16	64612639D	2	Front Gas Legend Shock Absorber	\$ 244.03
17	64612111	2	Rear Gas Legend Shock Absorber	\$ 244.03

SUSPENSION KITS

Kit Type	Part No.	Qty. per vehicle	Kit Description	List Price EACH
B	SUZKIT004-B	1	RAISED	\$ 2,777.97
C	SUZKIT004-C	1	RAISED HEAVY DUTY	\$ 2,983.37

ACCESSORIES (Not included in Kit)

Item	Part No.	Qty. per vehicle	Accessory Description	List Price EACH
1A	N31062	1	Front Urethane Bush Kit- Shock Absorber Lower	\$ 25.77
2A	N31469	1	Rear Urethane Bush Kit- Shock Absorber Upper/Lower	\$ 31.19

Part No.	Load Rating	Description
All spring load ratings are an approximate only. Vehicle ride heights will vary depending on load and accessories fitted.		
SK-7	0 to 60kg Constant Load	Suits Alloy Bull Bar
SK-7HD	60 to 120kg Constant Load	Suits Steel Bull Bar
SK-8	0 to 100kg Constant Load	
SK-8HD	60 to 120kg Constant Load	

SUZUKI- Vitara
TD J1X Hard Top and Soft Top SWB & LWB
8/91-3/98
Coil/Coil



KIT COMPONENTS

Item	Part No.	Qty. per vehicle	Description	List Price EACH
1	SFR-10	2	Front Coil Springs- Raised (B)	\$ 111.28
2	SRR-11	2	Rear Coil Springs- Raised (B)	\$ 111.28
3	64655613	2	Front Gas Legend Strut	NLA
4	6460035V	2	Rear Gas Legend Shock Absorber	\$ 244.03

SUSPENSION KITS

Kit Type	Part No.	Qty. per vehicle	Kit Description	List Price EACH
B	SUZKIT005-B	1	RAISED	\$ 933.18

SUZUKI- Vitara
TD J1X Grand Vitara Wagon LWB
4/98-05
Coil/Coil



KIT COMPONENTS

Item	Part No.	Qty. per vehicle	Description	List Price EACH
1	SFR-35	2	Front Coil Springs- Raised (B)	\$ 111.28
2	SRR-36	2	Rear Coil Springs- Raised (B)	\$ 111.28
3	64655613	2	NLA	\$ -
4	6460035V	2	Rear Gas Legend Shock Absorber	\$ 244.03

SUSPENSION KITS

Kit Type	Part No.	Qty. per vehicle	Kit Description	List Price EACH
B	SUZKIT006-B	1	RAISED	\$ 933.18

Part No.	Load Rating	Description
All spring load ratings are an approximate only. Vehicle ride heights will vary depending on load and accessories fitted.		
SFR-10	0 to 100kg Constant Load	Suits Steel Bull Bar
SFR-35	0 to 100kg Constant Load	Suits Steel Bull Bar
SRR-11	0 to 100kg Constant Load	
SRR-36	0 to 100kg Constant Load	

SUZUKI- Vitara
XL7 Wagon (7 seater)
8/01 on
Coil/Coil

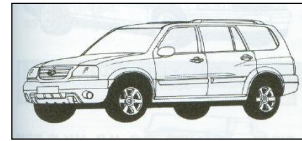

KIT COMPONENTS

Item	Part No.	Qty. per vehicle	Description	List Price EACH
1	SFR-30HD	2	Front Coil Springs- Raised (B)	\$ 111.28
2	SRR-35	2	Rear Coil Springs- Raised (B)	\$ 111.28
3	64655613	2	Front Gas Legend Strut	NLA
4	6460035V	2	Rear Gas Legend Shock Absorber	\$ 244.03

SUSPENSION KITS

Kit Type	Part No.	Qty. per vehicle	Kit Description	List Price EACH
B	SUZKIT007-B	1	RAISED	\$ 933.18

Part No.	Load Rating	Description
All spring load ratings are an approximate only. Vehicle ride heights will vary depending on load and accessories fitted.		
SFR-30HD	0 to 100kg Constant Load	Suits Steel Bull Bar
SFR-35	100 to 150kg Constant Load	Suits Steel Bull Bar, Winch, Underbody Protection etc.

TOYOTA- FJ Cruiser
Wagon
06 on
Coil/Coil

KIT COMPONENTS

Item	Part No.	Qty. per vehicle	Description	List Price EACH
1	TFS-118	2	Front Coil Springs- Standard Height (A)	\$ 126.26
2	TFR-118	2	Front Coil Springs- Raised (B)	\$ 126.26
3	TFR-118HD	2	Front Coil Springs- Raised Heavy Duty (C)	\$ 126.26
4	TRS-119	2	Rear Coil Springs- Standard Height (A)	\$ 126.26
5	TRR-119	2	Rear Coil Springs- Raised (B)	\$ 126.26
6	TRR-119HD	2	Rear Coil Springs- Raised Heavy Duty (C)	\$ 126.26
7	64610087F	2	Front Gas Legend Strut	\$ 332.11
8	64612489	2	Rear Gas Legend Shock Absorber	\$ 267.49

SUSPENSION KITS

Kit Type	Part No.	Qty. per vehicle	Kit Description	List Price EACH
A	TOYKIT066-A	1	STANDARD HEIGHT	\$ 1,704.24
B	TOYKIT066-B	1	RAISED	\$ 1,704.24
C	TOYKIT066-C	1	RAISED HEAVY DUTY	\$ 1,704.24

Optional parts

Item	Part No.	Qty. per vehicle	Option Description	List Price EACH
1A	LOVUCA-PRA	1	Lovells Extreme Upper Control Arm kit	\$ 920.00

ACCESSORIES (Not included in Kit)

Item	Part No.	Qty. per vehicle	Accessory Description	List Price EACH
1A	X53270	1	Front Urethane Bush Kit- Control Arm- Upper Inner ADJ	\$ 359.71
2A	N53313	1	Front Urethane Bush Kit- Control Arm- Upper Inner STD	\$ 307.29
3A	N63215	1	Rear Urethane Bush Kit- Trailing Arm- Upper	\$ 295.74
4A	SBS-003	1	Front Sway Bar Spacer Kit	\$ 105.90

Highlighted Accessories: Lovells strongly recommend fitting these Part Numbers for all applications.

NOTE: Lovells front coil springs will not fit struts with a rolled lower spring seat. For correct fitment always use with a Lovells strut.

Part No.	Load Rating	Description
All spring load ratings are an approximate only. Vehicle ride heights will vary depending on load and accessories fitted.		
TFS-118	0 to 100kg Constant Load	Suits Steel Bull Bar
TFR-118	0 to 100kg Constant Load	Suits Steel Bull Bar
TFR-118HD	100 to 150kg Constant Load	Suits Steel Bull Bar, Winch, Underbody Protection etc.
TRS-119	0 to 100kg Constant Load	
TRR-119	0 to 100kg Constant Load	
TRR-119HD	150 to 250kg Constant Load	

TOYOTA- 4 Runner
YN60 Wagon (Petrol)
7/84-10/85
Leaf/Leaf

KIT COMPONENTS

Item	Part No.	Qty. per vehicle	Description	List Price EACH
1	TL-7SH	2	Front Leaf Springs- Standard Height (A)	\$ 414.30
2	TL-7	2	Front Leaf Springs- Raised (B)	\$ 416.30
3	TL-23	2	Front Leaf Springs- Raised Heavy Duty (C)	\$ 438.82
4	TL-17SH	2	Rear Leaf Springs- Standard Height (A)	\$ 604.96
5	TL-17	2	Rear Leaf Springs- Raised (B)	\$ 629.75
6	TL-17HD	2	Rear Leaf Springs- Raised Heavy Duty (C)	\$ 660.85
7	N71041	1	Front Urethane Bush Kit- Spring Front eyes	\$ 36.82
8	N71041	1	Front Urethane Bush Kit- Spring Rear eyes	\$ 36.82
9	N71093	1	Front Urethane Bush Kit- Spring Shackle	\$ 48.57
10	N71041	3	Rear Urethane Kit- Spring Front/Rear eyes/Shackle	\$ 36.82
11	UBL-12	1	Front Drivers Side U-Bolt	\$ 39.38
12	UBL-06	1	Front Passenger Side U-Bolt	\$ 24.61
13	UBL-05	2	Front Driver and Passenger Side U-Bolts	\$ 24.61
14	UBL-05	4	Rear U-Bolts	\$ 24.61
15	LGSK384	2	Front Greasable Shackle Kit	\$ 53.93
16	LGPK385	2	Front Greasable Pin Kit	\$ 40.13
17	LGSK386	2	Rear Greasable Shackle Kit	\$ 53.93
18	LGPK385	2	Rear Greasable Pin Kit	\$ 40.13
19	64612526	2	Front Gas Legend Shock Absorber	\$ 244.03
20	64612525	2	Rear Gas Legend Shock Absorber	\$ 269.66

SUSPENSION KITS

Kit Type	Part No.	Qty. per vehicle	Kit Description	List Price EACH
A	TOYKIT001-A	1	STANDARD HEIGHT	\$ 3,886.42
B	TOYKIT001-B	1	RAISED	\$ 3,940.00
C	TOYKIT001-C	1	RAISED HEAVY DUTY	\$ 4,047.24

Part No.	Load Rating	Description
All spring load ratings are an approximate only. Vehicle ride heights will vary depending on load and accessories fitted.		
TL-7SH	0 to 100kg Constant Load	Suits Steel Bull Bar
TL-7	0 to 100kg Constant Load	Suits Steel Bull Bar
TL-17SH	0 to 100kg Constant Load	
TL-17	0 to 100kg Constant Load	
TL-17HD	150 to 250kg Constant Load	

TOYOTA- 4 Runner
LN60 Wagon (Diesel)
7/84-10/85
Leaf/Leaf

KIT COMPONENTS

Item	Part No.	Qty. per vehicle	Description	List Price EACH
1	TL-23SH	2	Front Leaf Springs- Standard Height (A)	\$ 439.32
2	TL-23	2	Front Leaf Springs- Raised (B)	\$ 438.82
3	TL-23HD	2	Front Leaf Springs- Raised Heavy Duty (C)	\$ 460.67
4	TL-17SH	2	Rear Leaf Springs- Standard Height (A)	\$ 604.96
5	TL-17	2	Rear Leaf Springs- Raised (B)	\$ 629.75
6	TL-17HD	2	Rear Leaf Springs- Raised Heavy Duty (C)	\$ 660.85
7	N71041	1	Front Urethane Bush Kit- Spring Front eyes	\$ 36.82
8	N71041	1	Front Urethane Bush Kit- Spring Rear eyes	\$ 36.82
9	N71093	1	Front Urethane Bush Kit- Spring Shackle	\$ 48.57
10	N71041	3	Rear Urethane Kit- Spring Front/Rear eyes/Shackle	\$ 36.82
11	UBL-12	1	Front Drivers Side U-Bolt	\$ 39.38
12	UBL-06	1	Front Passenger Side U-Bolt	\$ 24.61
13	UBL-05	2	Front Driver and Passenger Side U-Bolts	\$ 24.61
14	UBL-05	4	Rear U-Bolts	\$ 24.61
15	LGSK384	2	Front Greasable Shackle Kit	\$ 53.93
16	LGPK385	2	Front Greasable Pin Kit	\$ 40.13
17	LGSK386	2	Rear Greasable Shackle Kit	\$ 53.93
18	LGPK385	2	Rear Greasable Pin Kit	\$ 40.13
19	64612526	2	Front Gas Legend Shock Absorber	\$ 244.03
20	64612525	2	Rear Gas Legend Shock Absorber	\$ 269.66

SUSPENSION KITS

Kit Type	Part No.	Qty. per vehicle	Kit Description	List Price EACH
A	TOYKIT002-A	1	STANDARD HEIGHT	\$ 3,936.46
B	TOYKIT002-B	1	RAISED	\$ 3,985.04
C	TOYKIT002-C	1	RAISED HEAVY DUTY	\$ 4,090.94

Part No.	Load Rating	Description
All spring load ratings are an approximate only. Vehicle ride heights will vary depending on load and accessories fitted.		
TL-23SH	0 to 100kg Constant Load	Suits Steel Bull Bar
TL-23	0 to 100kg Constant Load	Suits Steel Bull Bar
TL-23HD	100 to 150kg Constant Load	Suits Steel Bull Bar, Winch, Underbody Protection etc.
TL-17SH	0 to 100kg Constant Load	
TL-17	0 to 100kg Constant Load	
TL-17HD	150 to 250kg Constant Load	

TOYOTA- 4 Runner
LN61/YN63 Wagon (Petrol and Diesel)
11/85-5/89
Torsion Bar/Leaf

KIT COMPONENTS

Item	Part No.	Qty. per vehicle	Description	List Price EACH
1	TOY026	1 Pair	Front Heavy Duty Torsion Bars	\$ 660.33
2	TL-24	2	Rear Leaf Springs- Raised (B)	\$ 495.18
3	N71041	3	Rear Urethane Kit- Spring Front/Rear eyes/Shackle	\$ 36.82
4	UBL-05	4	Rear U-Bolts	\$ 24.61
5	LGSK386	2	Rear Greasable Shackle Kit	\$ 53.93
6	LGPK385	2	Rear Greasable Pin Kit	\$ 40.13
7	64612544	2	Front Gas Legend Shock Absorber	\$ 244.03
8	64612576	2	Rear Gas Legend Shock Absorber	\$ 244.03

SUSPENSION KITS

Kit Type	Part No.	Qty. per vehicle	Kit Description	List Price EACH
B	TOYKIT003-B	1	RAISED	\$ 3,023.80

ACCESSORIES (Not included in Kit)

Item	Part No.	Qty. per vehicle	Accessory Description	List Price EACH
1A	N51689	1	Front Urethane Bush Kit- Lower Control Arm-Inner	\$ 201.07
2A	N11208	1	Front Urethane Bush Kit- Steering Idler Bush	\$ 21.11
3A	N21135	1	Front Urethane Bush Kit- Sway Bar Link	\$ 76.47

Part No.	Load Rating	Description
All spring load ratings are an approximate only. Vehicle ride heights will vary depending on load and accessories fitted.		
TL-24	0 to 100kg Constant Load	Suits Steel Bull Bar

**TOYOTA- 4 Runner and Surf
 LN/RN130 Wagon (Petrol and Diesel)
 10/89-6/96
 Torsion Bar/Coil**

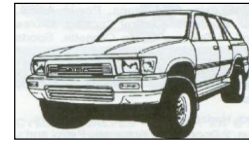

KIT COMPONENTS

Item	Part No.	Qty. per vehicle	Description	List Price EACH
1	TOY026	1 Pair	Front Heavy Duty Torsion Bars	\$ 660.33
2	TRS-46	2	Rear Coil Springs- Standard Height (A)	\$ 126.26
3	TRR-46	2	Rear Coil Springs- Raised (B)	\$ 126.26
4	TRR-46HD	2	Rear Coil Springs- Raised Heavy Duty (C)	\$ 126.26
5	64612544	2	Front Gas Legend Shock Absorber	\$ 244.03
6	64612572	2	Rear Gas Legend Shock Absorber	\$ 244.03

SUSPENSION KITS

Kit Type	Part No.	Qty. per vehicle	Kit Description	List Price EACH
A	TOYKIT004-A	1	STANDARD HEIGHT	\$ 1,888.95
B	TOYKIT004-B	1	RAISED	\$ 1,888.95
C	TOYKIT004-C	1	RAISED HEAVY DUTY	\$ 1,888.95

ACCESSORIES (Not included in Kit)

Item	Part No.	Qty. per vehicle	Accessory Description	List Price EACH
1A	N51690	1	Front Urethane Bush Kit- Upper Control Arm-Front Inner	\$ 148.12
2A	N51691	1	Front Urethane Bush Kit- Upper Control Arm-Rear Inner	\$ 181.59
3A	N51695	1	Front Urethane Bush Kit- Lower Control Arm-Inner	\$ 302.18
4A	N11693 (to 8/91 build date)	1	Front Urethane Bush Kit- Steering Idler Bush	\$ 27.41
5A	N11208 (8/91 on build date)	1	Front Urethane Bush Kit- Steering Idler Bush	\$ 21.11
6A	N21173	1	Front Urethane Bush Kit- Sway Bar Link	\$ 36.81
7A	N21058	1	Front Urethane Bush Kit- Sway Bar Mount (24mm)	\$ 30.34
8A	N21212	1	Front Urethane Bush Kit- Sway Bar Mount (25mm)	\$ 30.34
9A	N21105	1	Rear Urethane Bush Kit- Sway Bar Mount (21mm)	\$ 30.11
10A	LPR019	1	Rear Adjustable Panhard Rod Assembly	\$ 491.15

Highlighted Accessories: Lovells strongly recommend fitting these accessories when using Raised OR Raised Heavy Duty coil springs.

STEERING DAMPERS (Not included in Kit)

Item	Part No.	Qty. per vehicle	Description	List Price EACH
1B	5450014	1	Steering Damper Assembly- Heavy Duty	\$ 161.74

Part No.	Load Rating	Description
All spring load ratings are an approximate only. Vehicle ride heights will vary depending on load and accessories fitted.		
TRS-46	0 to 100kg Constant Load	Suits Steel Bull Bar
TRR-46	0 to 100kg Constant Load	Suits Steel Bull Bar
TRR-46HD	100 to 150kg Constant Load	

TOYOTA- Fortuner
Wagon
01/15 on
Coil/Coil

KIT COMPONENTS

Item	Part No.	Qty. per vehicle	Description	List Price EACH
1	TFR-118	2	Front Coil Springs- Raised (B)	\$ 126.26
2	TFR-118HD	2	Front Coil Springs- Raised Heavy Duty (C)	\$ 126.26
3	TRR-142	2	Rear Coil Springs- Raised (B)	\$ 127.90
4	TRR-142HD	2	Rear Coil Springs- Raised Heavy Duty (C)	\$ 126.26
5	64610087A	2	Front Gas Legend Strut	\$ 331.29
6	64611048	2	Rear Gas Legend Shock Absorber	\$ 244.03

SUSPENSION KITS

Kit Type	Part No.	Qty. per vehicle	Kit Description	List Price EACH
B	TOYKIT081-B	1	RAISED	\$ 1,658.96
C	TOYKIT081-C	1	RAISED HEAVY DUTY	\$ 1,655.67

NOTE: Lovells front coil springs will not fit struts with a rolled lower spring seat. For correct fitment always use with a Lovells strut.

Part No.	Load Rating	Description
All spring load ratings are an approximate only. Vehicle ride heights will vary depending on load and accessories fitted.		
TFR-118	0 to 100kg Constant Load	Suits Steel Bull Bar
TFR-118HD	100 to 150kg Constant Load	Suits Steel Bull Bar, Winch, Underbody Protection etc.
TRR-142	0 to 100kg Constant Load	
TRR-142HD	150 to 250kg Constant Load	

TOYOTA- Hilux
RN36-46 (Petrol)
1/79-7/83
Leaf/Leaf

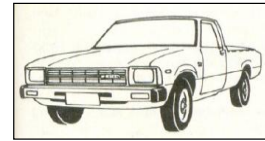

KIT COMPONENTS

Item	Part No.	Qty. per vehicle	Description	List Price EACH
1	TL-29	2	Front Leaf Springs- Standard Height (A)	\$ 414.30
2	TL-7SH	2	Front Leaf Springs- Raised (B)	\$ 414.30
3	TL-7	2	Front Leaf Springs- Raised Heavy Duty (C)	\$ 416.30
4	TL-17SH	2	Rear Leaf Springs- Standard Height (A)	\$ 604.96
5	TL-17	2	Rear Leaf Springs- Raised (B)	\$ 629.75
6	TL-17HD	2	Rear Leaf Springs- Raised Heavy Duty (C)	\$ 660.85
7	N71041	1	Front Urethane Bush Kit- Spring Front eyes	\$ 36.82
8	N71041	1	Front Urethane Bush Kit- Spring Rear eyes	\$ 36.82
9	N71093	1	Front Urethane Bush Kit- Spring Shackle	\$ 48.57
10	N71041	3	Rear Urethane Kit- Spring Front/Rear eyes/Shackle	\$ 36.82
11	UBL-12	1	Front Drivers Side U-Bolt	\$ 39.38
12	UBL-06	1	Front Passenger Side U-Bolt	\$ 24.61
13	UBL-05	2	Front Driver and Passenger Side U-Bolts	\$ 24.61
14	UBL-05	4	Rear U-Bolts	\$ 24.61
15	LGSK384	2	Front Greasable Shackle Kit	\$ 53.93
16	LGPK385	2	Front Greasable Pin Kit	\$ 40.13
17	LGSK386	2	Rear Greasable Shackle Kit	\$ 53.93
18	LGPK385	2	Rear Greasable Pin Kit	\$ 40.13
19	64612526	2	Front Gas Legend Shock Absorber	\$ 244.03
20	6462258B	2	Rear Gas Legend Shock Absorber	\$ 269.38

SUSPENSION KITS

Kit Type	Part No.	Qty. per vehicle	Kit Description	List Price EACH
A	TOYKIT005-A	1	STANDARD HEIGHT	\$ 3,885.87
B	TOYKIT005-B	1	RAISED	\$ 3,935.45
C	TOYKIT005-C	1	RAISED HEAVY DUTY	\$ 4,001.65

ACCESSORIES (Not included in Kit)

Item	Part No.	Qty. per vehicle	Accessory Description	List Price EACH
1A	N11693	1	Front Urethane Bush Kit- Steering Idler Bush	\$ 27.41

STEERING DAMPERS (Not included in Kit)

Item	Part No.	Qty. per vehicle	Description	List Price EACH
1B	5450013	1	Steering Damper Assembly- Heavy Duty	\$ 161.74
2B	5450013-RTC	1	Steering Damper Assembly- Return to Centre	\$ 201.67

Part No.	Load Rating	Description
All spring load ratings are an approximate only. Vehicle ride heights will vary depending on load and accessories fitted.		
TL-29	0 to 100kg Constant Load	Suits Steel Bull Bar
TL-7SH	0 to 100kg Constant Load	Suits Steel Bull Bar
TL-7	100 to 150kg Constant Load	Suits Steel Bull Bar, Winch, Underbody Protection etc.
TL-17SH	0 to 100kg Constant Load	
TL-17	0 to 100kg Constant Load	
TL-17HD	150 to 250kg Constant Load	

TOYOTA- Hilux
RN50 (Petrol)
8/83-8/88
Leaf/Leaf



KIT COMPONENTS

Item	Part No.	Qty. per vehicle	Description	List Price EACH
1	TL-29	2	Front Leaf Springs- Standard Height (A)	\$ 414.30
2	TL-7SH	2	Front Leaf Springs- Raised (B)	\$ 414.30
3	TL-7	2	Front Leaf Springs- Raised Heavy Duty (C)	\$ 416.30
4	TL-17SH	2	Rear Leaf Springs- Standard Height (A)	\$ 604.96
5	TL-17	2	Rear Leaf Springs- Raised (B)	\$ 629.75
6	TL-17HD	2	Rear Leaf Springs- Raised Heavy Duty (C)	\$ 660.85
7	N71041	1	Front Urethane Bush Kit- Spring Front eyes	\$ 36.82
8	N71041	1	Front Urethane Bush Kit- Spring Rear eyes	\$ 36.82
9	N71093	1	Front Urethane Bush Kit- Spring Shackle	\$ 48.57
10	N71041	3	Rear Urethane Kit- Spring Front/Rear eyes/Shackle	\$ 36.82
11	UBL-12	1	Front Drivers Side U-Bolt	\$ 39.38
12	UBL-06	1	Front Passenger Side U-Bolt	\$ 24.61
13	UBL-05	2	Front Driver and Passenger Side U-Bolts	\$ 24.61
14	UBL-05	4	Rear U-Bolts	\$ 24.61
15	LGSK384	2	Front Greasable Shackle Kit	\$ 53.93
16	LGPK385	2	Front Greasable Pin Kit	\$ 40.13
17	LGSK386	2	Rear Greasable Shackle Kit	\$ 53.93
18	LGPK385	2	Rear Greasable Pin Kit	\$ 40.13
19	64612526	2	Front Gas Legend Shock Absorber	\$ 244.03
20	64612525	2	Rear Gas Legend Shock Absorber	\$ 269.66

SUSPENSION KITS

Kit Type	Part No.	Qty. per vehicle	Kit Description	List Price EACH
A	TOYKIT006-A	1	STANDARD HEIGHT	\$ 3,886.42
B	TOYKIT006-B	1	RAISED	\$ 3,936.00
C	TOYKIT006-C	1	RAISED HEAVY DUTY	\$ 4,002.20

STEERING DAMPERS (Not included in Kit)

Item	Part No.	Qty. per vehicle	Description	List Price EACH
1B	5450013	1	Steering Damper Assembly- Heavy Duty	\$ 161.74
2B	5450013-RTC	1	Steering Damper Assembly- Return to Centre	\$ 201.67

Part No.	Load Rating	Description
All spring load ratings are an approximate only. Vehicle ride heights will vary depending on load and accessories fitted.		
TL-29	0 to 100kg Constant Load	Suits Steel Bull Bar
TL-7SH	0 to 100kg Constant Load	Suits Steel Bull Bar
TL-7	100 to 150kg Constant Load	Suits Steel Bull Bar, Winch, Underbody Protection etc.
TL-17SH	0 to 100kg Constant Load	
TL-17	0 to 100kg Constant Load	
TL-17HD	150 to 250kg Constant Load	

TOYOTA- Hilux
RN36,46,105 (Petrol)
8/83-12/97
Leaf/Leaf

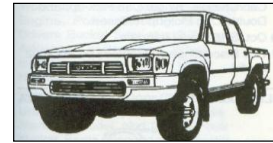

KIT COMPONENTS

Item	Part No.	Qty. per vehicle	Description	List Price EACH
1	TL-7SH	2	Front Leaf Springs- Standard Height (A)	\$ 414.30
2	TL-7	2	Front Leaf Springs- Raised (B)	\$ 416.30
3	TL-23	2	Front Leaf Springs- Raised Heavy Duty (C)	\$ 438.82
4	TL-17SH	2	Rear Leaf Springs- Standard Height (A)	\$ 604.96
5	TL-17	2	Rear Leaf Springs- Raised (B)	\$ 629.75
6	TL-17HD	2	Rear Leaf Springs- Raised Heavy Duty (C)	\$ 660.85
7	N71041	1	Front Urethane Bush Kit- Spring Front eyes	\$ 36.82
8	N71041	1	Front Urethane Bush Kit- Spring Rear eyes	\$ 36.82
9	N71093	1	Front Urethane Bush Kit- Spring Shackle	\$ 48.57
10	N71041	3	Rear Urethane Kit- Spring Front/Rear eyes/Shackle	\$ 36.82
11	UBL-12	1	Front Drivers Side U-Bolt	\$ 39.38
12	UBL-06	1	Front Passenger Side U-Bolt	\$ 24.61
13	UBL-05	2	Front Driver and Passenger Side U-Bolts	\$ 24.61
14	UBL-05	4	Rear U-Bolts	\$ 24.61
15	LGSK384	2	Front Greasable Shackle Kit	\$ 53.93
16	LGPK385	2	Front Greasable Pin Kit	\$ 40.13
17	LGSK386	2	Rear Greasable Shackle Kit	\$ 53.93
18	LGPK385	2	Rear Greasable Pin Kit	\$ 40.13
19	64612526	2	Front Gas Legend Shock Absorber	\$ 244.03
20	64612525	2	Rear Gas Legend Shock Absorber	\$ 269.66

SUSPENSION KITS

Kit Type	Part No.	Qty. per vehicle	Kit Description	List Price EACH
A	TOYKIT007-A	1	STANDARD HEIGHT	\$ 3,886.42
B	TOYKIT007-B	1	RAISED	\$ 3,940.00
C	TOYKIT007-C	1	RAISED HEAVY DUTY	\$ 4,047.24

STEERING DAMPERS (Not included in Kit)

Item	Part No.	Qty. per vehicle	Description	List Price EACH
1B	5450013	1	Steering Damper Assembly- Heavy Duty	\$ 161.74
2B	5450013-RTC	1	Steering Damper Assembly- Return to Centre	\$ 201.67

Part No.	Load Rating	Description
All spring load ratings are an approximate only. Vehicle ride heights will vary depending on load and accessories fitted.		
TL-7SH	0 to 100kg Constant Load	Suits Steel Bull Bar
TL-7	0 to 100kg Constant Load	Suits Steel Bull Bar
TL-23	100 to 150kg Constant Load	Suits Steel Bull Bar, Winch, Underbody Protection etc.
TL-17SH	0 to 100kg Constant Load	
TL-17	0 to 100kg Constant Load	
TL-17HD	150 to 250kg Constant Load	

TOYOTA- Hilux
LN65, 67, 106, 111 (Diesel)
8/83-12/97
Leaf/Leaf



KIT COMPONENTS

Item	Part No.	Qty. per vehicle	Description	List Price EACH
1	TL-23SH	2	Front Leaf Springs- Standard Height (A)	\$ 439.32
2	TL-23	2	Front Leaf Springs- Raised (B)	\$ 438.82
3	TL-23HD	2	Front Leaf Springs- Raised Heavy Duty (C)	\$ 460.67
4	TL-17SH	2	Rear Leaf Springs- Standard Height (A)	\$ 604.96
5	TL-17	2	Rear Leaf Springs- Raised (B)	\$ 629.75
6	TL-17HD	2	Rear Leaf Springs- Raised Heavy Duty (C)	\$ 660.85
7	N71041	1	Front Urethane Bush Kit- Spring Front eyes	\$ 36.82
8	N71041	1	Front Urethane Bush Kit- Spring Rear eyes	\$ 36.82
9	N71093	1	Front Urethane Bush Kit- Spring Shackle	\$ 48.57
10	N71041	3	Rear Urethane Kit- Spring Front/Rear eyes/Shackle	\$ 36.82
11	UBL-12	1	Front Drivers Side U-Bolt	\$ 39.38
12	UBL-06	1	Front Passenger Side U-Bolt	\$ 24.61
13	UBL-05	2	Front Driver and Passenger Side U-Bolts	\$ 24.61
14	UBL-05	4	Rear U-Bolts	\$ 24.61
15	LGSK384	2	Front Greasable Shackle Kit	\$ 53.93
16	LGPK385	2	Front Greasable Pin Kit	\$ 40.13
17	LGSK386	2	Rear Greasable Shackle Kit	\$ 53.93
18	LGPK385	2	Rear Greasable Pin Kit	\$ 40.13
19	64612526	2	Front Gas Legend Shock Absorber	\$ 244.03
20	64612525	2	Rear Gas Legend Shock Absorber	\$ 269.66

SUSPENSION KITS

Kit Type	Part No.	Qty. per vehicle	Kit Description	List Price EACH
A	TOYKIT008-A	1	STANDARD HEIGHT	\$ 3,936.46
B	TOYKIT008-B	1	RAISED	\$ 3,985.04
C	TOYKIT008-C	1	RAISED HEAVY DUTY	\$ 4,090.94

STEERING DAMPERS (Not included in Kit)

Item	Part No.	Qty. per vehicle	Description	List Price EACH
1B	5450013	1	Steering Damper Assembly- Heavy Duty	\$ 161.74
2B	5450013-RTC	1	Steering Damper Assembly- Return to Centre	\$ 201.67

Part No.	Load Rating	Description
All spring load ratings are an approximate only. Vehicle ride heights will vary depending on load and accessories fitted.		
TL-23SH	0 to 100kg Constant Load	Suits Steel Bull Bar
TL-23	0 to 100kg Constant Load	Suits Steel Bull Bar
TL-23HD	100 to 150kg Constant Load	Suits Steel Bull Bar, Winch, Underbody Protection etc.
TL-17SH	0 to 100kg Constant Load	
TL-17	0 to 100kg Constant Load	
TL-17HD	150 to 250kg Constant Load	

TOYOTA- Hilux
LN111, RN110 (Petrol and Diesel)
8/88-12/97
Torsion Bar/Leaf



KIT COMPONENTS

Item	Part No.	Qty. per vehicle	Description	List Price EACH
1	TOY026	1 Pair	Front Heavy Duty Torsion Bars	\$ 660.33
2	TL-34	2	Rear Leaf Springs- Raised (B)	\$ 750.88
3	N71506	1	Rear Urethane Bush Kit- Spring Front eyes	\$ 79.05
4	N71041	1	Rear Urethane Bush Kit- Spring Rear eyes	\$ 36.82
5	N71694	1	Rear Urethane Bush Kit- Spring Shackle	\$ 44.23
6	UBL-05	4	Rear U-Bolts	\$ 24.61
7	LGSK386/1	1	Rear Greasable Shackle Kit (Right Hand)	\$ 53.93
8	LGSK386/2	1	Rear Greasable Shackle Kit (Left Hand)	\$ 53.93
9	LGPK387-2	2	Rear Pin Kit (Non greasable)	\$ 47.08
10	64612544	2	Front Gas Legend Shock Absorber	\$ 244.03
11	64612525	2	Rear Gas Legend Shock Absorber	\$ 269.66

SUSPENSION KITS

Kit Type	Part No.	Qty. per vehicle	Kit Description	List Price EACH
B	TOYKIT009-B	1	RAISED	\$ 3.650.02

ACCESSORIES (Not included in Kit)

Item	Part No.	Qty. per vehicle	Accessory Description	List Price EACH
1A	N51690	1	Front Urethane Bush Kit- Upper Control Arm-Front Inner	\$ 148.12
2A	N51691	1	Front Urethane Bush Kit- Upper Control Arm-Rear Inner	\$ 181.59
3A	N51695	1	Front Urethane Bush Kit- Lower Control Arm-Inner	\$ 302.18
4A	N11693 (to 8/91 build date)	1	Front Urethane Bush Kit- Steering Idler Bush	\$ 27.41
5A	N11208 (8/91 on build date)	1	Front Urethane Bush Kit- Steering Idler Bush	\$ 21.11
6A	N21135	1	Front Urethane Bush Kit- Sway Bar Link	\$ 76.47
7A	N21058	1	Front Urethane Bush Kit- Sway Bar Mount (24mm)	\$ 30.34
8A	N21212	1	Front Urethane Bush Kit- Sway Bar Mount (25mm)	\$ 30.34

STEERING DAMPERS (Not included in Kit)

Item	Part No.	Qty. per vehicle	Description	List Price EACH
1B	5450014	1	Steering Damper Assembly- Heavy Duty	\$ 161.74

Part No.	Load Rating	Description
All spring load ratings are an approximate only. Vehicle ride heights will vary depending on load and accessories fitted.		
TL-34	0 to 100kg Constant Load	

TOYOTA- Hilux
YN65, 67 (Petrol)
8/83-7/97
Leaf/Leaf

KIT COMPONENTS

Item	Part No.	Qty. per vehicle	Description	List Price EACH
1	TL-7SH	2	Front Leaf Springs- Standard Height (A)	\$ 414.30
2	TL-7	2	Front Leaf Springs- Raised (B)	\$ 416.30
3	TL-23	2	Front Leaf Springs- Raised Heavy Duty (C)	\$ 438.82
4	TL-17SH	2	Rear Leaf Springs- Standard Height (A)	\$ 604.96
5	TL-17	2	Rear Leaf Springs- Raised (B)	\$ 629.75
6	TL-17HD	2	Rear Leaf Springs- Raised Heavy Duty (C)	\$ 660.85
7	N71041	1	Front Urethane Bush Kit- Spring Front eyes	\$ 36.82
8	N71041	1	Front Urethane Bush Kit- Spring Rear eyes	\$ 36.82
9	N71093	1	Front Urethane Bush Kit- Spring Shackle	\$ 48.57
10	N71041	3	Rear Urethane Kit- Spring Front/Rear eyes/Shackle	\$ 36.82
11	UBL-12	1	Front Drivers Side U-Bolt	\$ 39.38
12	UBL-06	1	Front Passenger Side U-Bolt	\$ 24.61
13	UBL-05	2	Front Driver and Passenger Side U-Bolts	\$ 24.61
14	UBL-05	4	Rear U-Bolts	\$ 24.61
15	LGSK384	2	Front Greasable Shackle Kit	\$ 53.93
16	LGPK385	2	Front Greasable Pin Kit	\$ 40.13
17	LGSK386	2	Rear Greasable Shackle Kit	\$ 53.93
18	LGPK385	2	Rear Greasable Pin Kit	\$ 40.13
19	64612526	2	Front Gas Legend Shock Absorber	\$ 244.03
20	64612525	2	Rear Gas Legend Shock Absorber	\$ 269.66

SUSPENSION KITS

Kit Type	Part No.	Qty. per vehicle	Kit Description	List Price EACH
A	TOYKIT010-A	1	STANDARD HEIGHT	\$ 3,886.42
B	TOYKIT010-B	1	RAISED	\$ 3,940.00
C	TOYKIT010-C	1	RAISED HEAVY DUTY	\$ 4,047.24

Part No.	Load Rating	Description
All spring load ratings are an approximate only. Vehicle ride heights will vary depending on load and accessories fitted.		
TL-7SH	0 to 100kg Constant Load	Suits Steel Bull Bar
TL-7	0 to 100kg Constant Load	Suits Steel Bull Bar
TL-23	100 to 150kg Constant Load	Suits Steel Bull Bar, Winch, Underbody Protection etc.
TL-17SH	0 to 100kg Constant Load	
TL-17	0 to 100kg Constant Load	
TL-17HD	150 to 250kg Constant Load	

TOYOTA- Hilux
LN167RP, RZN169RP (Petrol and Diesel)
11/97-3/05
Torsion Bar/Leaf



KIT COMPONENTS

Item	Part No.	Qty. per vehicle	Description	List Price EACH
1	TOY026	1 Pair	Front Heavy Duty Torsion Bars	\$ 660.33
2	TL-34	2	Rear Leaf Springs- Raised (B)	\$ 750.88
3	N71506	1	Rear Urethane Bush Kit- Spring Front eyes	\$ 79.05
4	N71041	1	Rear Urethane Bush Kit- Spring Rear eyes	\$ 36.82
5	N71694	1	Rear Urethane Bush Kit- Spring Shackle	\$ 44.23
6	UBL-05	4	Rear U-Bolts	\$ 24.61
7	LGSK386/1	2	Rear Greasable Shackle Kit	\$ 53.93
8	LGPK387-2	2	Rear Pin Kit (Non greasable)	\$ 47.08
9	64612544	2	Front Gas Legend Shock Absorber	\$ 244.03
10	64612525	2	Rear Gas Legend Shock Absorber	\$ 269.66

SUSPENSION KITS

Kit Type	Part No.	Qty. per vehicle	Kit Description	List Price EACH
B	TOYKIT011-B	1	RAISED	\$ 3,650.02

ACCESSORIES (Not included in Kit)

Item	Part No.	Qty. per vehicle	Accessory Description	List Price EACH
1A	N52813	2	Front Urethane Bush Kit- Control Arm- Lower Inner	\$ 234.82

TOYOTA- Hilux
RZN167RT,169RT (Petrol and Diesel)
11/97-3/05
Torsion Bar/Leaf



KIT COMPONENTS

Item	Part No.	Qty. per vehicle	Description	List Price EACH
1	TOY026	1 Pair	Front Heavy Duty Torsion Bars	\$ 660.33
2	TL-38	2	Rear Leaf Springs- Raised (B)	\$ 731.24
3	TL-38HD	2	Rear Leaf Springs- Raised Heavy Duty (C)	\$ 835.55
4	N71506	1	Rear Urethane Bush Kit- Spring Front eyes	\$ 79.05
5	N71041	1	Rear Urethane Bush Kit- Spring Rear eyes	\$ 36.82
6	N71694	1	Rear Urethane Bush Kit- Spring Shackle	\$ 44.23
7	UBL-05	4	Rear U-Bolts	\$ 24.61
8	LGSK386/1	2	Rear Greasable Shackle Kit	\$ 53.93
10	LGPK387-2	2	Rear Pin Kit (Non greasable)	\$ 47.08
11	64612544	2	Front Gas Legend Shock Absorber	\$ 244.03
12	64612525	2	Rear Gas Legend Shock Absorber	\$ 269.66

SUSPENSION KITS

Kit Type	Part No.	Qty. per vehicle	Kit Description	List Price EACH
B	TOYKIT012-B	1	RAISED	\$ 3,610.73
C	TOYKIT012-C	1	RAISED HEAVY DUTY	\$ 3,819.35

ACCESSORIES (Not included in Kit)

Item	Part No.	Qty. per vehicle	Accessory Description	List Price EACH
1A	N52813	2	Front Urethane Bush Kit- Control Arm- Lower Inner	\$ 234.82

Part No.	Load Rating	Description
All spring load ratings are an approximate only. Vehicle ride heights will vary depending on load and accessories fitted.		
TL-34	0 to 100kg Constant Load	
TL-38	0 to 100kg Constant Load	
TL-38HD	150 to 250kg Constant Load	

TOYOTA- Hilux
GGN25R, KUN26R (150 Series) Single Cab Diesel - 4 cylinder)
3/05-9/15
Coil/Leaf

KIT COMPONENTS

Item	Part No.	Qty. per vehicle	Description	List Price EACH
1	TFR-118	2	Front Coil Springs- Raised (B)	\$ 126.26
2	TFR-118HD	2	Front Coil Springs- Raised Heavy Duty (C)	\$ 126.26
3	TL-61	2	Rear Leaf Springs- Raised (B)	\$ 701.01
4	TL-61HD	2	Rear Leaf Springs- Raised Heavy Duty (C)	\$ 798.50
5	N73254	1	Rear Urethane Bush Kit- Spring Front eyes	\$ 83.71
6	N73255	1	Rear Urethane Bush Kit- Spring Rear eyes/shackle	\$ 110.28
7	UBL-06	4	Rear U-Bolts	\$ 24.61
8	LGSK386/3	2	Rear Greasable Shackle Kit	\$ 53.93
9	LGPK387-2	2	Rear Pin Kit (Non Greasable)	\$ 47.08
10	64610087A	2	Front Gas Legend Strut	\$ 331.29
11	64612525	2	Rear Gas Legend Shock Absorber	\$ 269.66

SUSPENSION KITS

Kit Type	Part No.	Qty. per vehicle	Kit Description	List Price EACH
B	TOYKIT064-B	1	RAISED	\$ 3,350.88
C	TOYKIT064-C	1	RAISED HEAVY DUTY	\$ 3,545.86

Optional parts

Item	Part No.	Qty. per vehicle	Option Description	List Price EACH
1A	LOVUCA-HIL	1	Lovells Extreme Upper Control Arm kit	\$ 920.00

ACCESSORIES (Not included in Kit)

Item	Part No.	Qty. per vehicle	Accessory Description	List Price EACH
1A	LSPV001	1	Extension Nut for Load Sensing Pressure Valve	\$ 25.17
2A	N48000	2	Front Strut Top Mount Assembly	\$ 94.31
3A	SBS-001	1	Front Sway Bar Spacer Kit	\$ 105.90
4A	HCEB002	2	Rear Handbrake Cable Extension Bracket	\$ 27.69

Highlighted Accessories: Lovells strongly recommend fitting this OPTION in all applications.

ITEM 1A- Refer Page 147 for Tech Bulletin

Part No.	Load Rating	Description
All spring load ratings are an approximate only. Vehicle ride heights will vary depending on load and accessories fitted.		
TFR-118	0 to 100kg Constant Load	Suits Steel Bull Bar
TFR-118HD	100 to 150kg Constant Load	Suits Steel Bull Bar, Winch, Underbody Protection etc.
TL-61	0 to 100kg Constant Load	
TL-61HD	150 to 250kg Constant Load	

TOYOTA- Hilux
GGN25R, KUN26R (150 Series) Single Cab Petrol - 6 cylinder)
3/05-9/15
Coil/Leaf

KIT COMPONENTS

Item	Part No.	Qty. per vehicle	Description	List Price EACH
1	TFR-118HD	2	Front Coil Springs- Raised (B)	\$ 126.26
2	TFR-118EHD	2	Front Coil Springs- Raised Heavy Duty (C)	\$ 165.77
3	TL-61	2	Rear Leaf Springs- Raised (B)	\$ 701.01
4	TL-61HD	2	Rear Leaf Springs- Raised Heavy Duty (C)	\$ 798.50
5	N73254	1	Rear Urethane Bush Kit- Spring Front eyes	\$ 83.71
6	N73255	1	Rear Urethane Bush Kit- Spring Rear eyes/shackle	\$ 110.28
7	UBL-06	4	Rear U-Bolts	\$ 24.61
8	LGSK386/3	2	Rear Greasable Shackle Kit	\$ 53.93
9	LGPK387-2	2	Rear Pin Kit (Non Greasable)	\$ 47.08
10	64610087A	2	Front Gas Legend Strut	\$ 331.29
11	64612525	2	Rear Gas Legend Shock Absorber	\$ 269.66

SUSPENSION KITS

Kit Type	Part No.	Qty. per vehicle	Kit Description	List Price EACH
B	TOYKIT069-B	1	RAISED	\$ 3,350.88
C	TOYKIT069-C	1	RAISED HEAVY DUTY	\$ 3,624.88

Optional parts

Item	Part No.	Qty. per vehicle	Option Description	List Price EACH
1A	LOVUCA-HIL	1	Lovells Extreme Upper Control Arm kit	\$ 920.00

ACCESSORIES (Not included in Kit)

Item	Part No.	Qty. per vehicle	Accessory Description	List Price EACH
1A	LSPV001	1	Extension Nut for Load Sensing Pressure Valve	\$ 25.17
2A	N48000	2	Front Strut Top Mount Assembly	\$ 94.31
3A	SBS-001	1	Front Sway Bar Spacer Kit	\$ 105.90
4A	HCEB002	2	Rear Handbrake Cable Extension Bracket	\$ 27.69

Highlighted Accessories: Lovells strongly recommend fitting this OPTION in all applications.

ITEM 1A- Refer Page 147 for Tech Bulletin

NOTE: Lovells front coil springs will not fit struts with a rolled lower spring seat. For correct fitment always use with a Lovells strut.

Part No.	Load Rating	Description
All spring load ratings are an approximate only. Vehicle ride heights will vary depending on load and accessories fitted.		
TFR-118	0 to 100kg Constant Load	Suits Steel Bull Bar
TFR-118HD	100 to 150kg Constant Load	Suits Steel Bull Bar, Winch, Underbody Protection etc.
TFR-118EHD	150 to 200kg Constant Load	Suits Steel Bull Bar, Winch, Underbody Protection etc.
TL-61	0 to 100kg Constant Load	
TL-61HD	150 to 250kg Constant Load	

TOYOTA- Hilux
GGN25R, KUN26R (150 Series) Dual Cab & Xtra Cab - Diesel 4 cylinder
3/05-9/15
Coil/Leaf

KIT COMPONENTS

Item	Part No.	Qty. per vehicle	Description	List Price EACH
1	TFR-118	2	Front Coil Springs- Raised (B)	\$ 126.26
2	TFR-118HD	2	Front Coil Springs- Raised Heavy Duty (C)	\$ 126.26
3	TL-60	2	Rear Leaf Springs- Raised (B)	\$ 645.80
4	TL-60HD	2	Rear Leaf Springs- Raised Heavy Duty (C)	\$ 742.56
5	N73254	1	Rear Urethane Bush Kit- Spring Front eyes	\$ 83.71
6	N73255	1	Rear Urethane Bush Kit- Spring Rear eyes/shackle	\$ 110.28
7	UBL-06	4	Rear U-Bolts	\$ 24.61
8	LGSK386/3	2	Rear Greasable Shackle Kit	\$ 53.93
9	LGPK387-2	2	Rear Pin Kit (Non Greasable)	\$ 47.08
10	64610087A	2	Front Gas Legend Strut	\$ 331.29
11	64612525	2	Rear Gas Legend Shock Absorber	\$ 269.66

SUSPENSION KITS

Kit Type	Part No.	Qty. per vehicle	Kit Description	List Price EACH
B	TOYKIT065-B	1	RAISED	\$ 3,240.46
C	TOYKIT065-C	1	RAISED HEAVY DUTY	\$ 3,433.98

Optional parts

Item	Part No.	Qty. per vehicle	Option Description	List Price EACH
1A	LOVUCA-HIL	1	Lovells Extreme Upper Control Arm kit	\$ 920.00

ACCESSORIES (Not included in Kit)

Item	Part No.	Qty. per vehicle	Accessory Description	List Price EACH
1A	LSPV001	1	Extension Nut for Load Sensing Pressure Valve	\$ 25.17
2A	N48000	2	Front Strut Top Mount Assembly	\$ 94.31
3A	SBS-001	1	Front Sway Bar Spacer Kit	\$ 105.90
4A	HCEB002	2	Rear Handbrake Cable Extension Bracket	\$ 27.69

Highlighted Accessories: Lovells strongly recommend fitting this OPTION in all applications.

ITEM 1A- Refer Page 147 for Tech Bulletin

Part No.	Load Rating	Description
All spring load ratings are an approximate only. Vehicle ride heights will vary depending on load and accessories fitted.		
TFR-118	0 to 100kg Constant Load	Suits Steel Bull Bar
TFR-118HD	100 to 150kg Constant Load	Suits Steel Bull Bar, Winch, Underbody Protection etc.
TL-60	0 to 100kg Constant Load	
TL-60HD	150 to 250kg Constant Load	

TOYOTA- Hilux
GGN25R, KUN26R (150 Series) Dual Cab & Xtra Cab (Petrol - 6 cylinder)
3/05-9/15
Coil/Leaf



KIT COMPONENTS

Item	Part No.	Qty. per vehicle	Description	List Price EACH
1	TFR-118HD	2	Front Coil Springs- Raised (B)	\$ 126.26
2	TFR-118EHD	2	Front Coil Springs- Raised Heavy Duty (C)	\$ 165.77
3	TL-60	2	Rear Leaf Springs- Raised (B)	\$ 645.80
4	TL-60HD	2	Rear Leaf Springs- Raised Heavy Duty (C)	\$ 742.56
5	N73254	1	Rear Urethane Bush Kit- Spring Front eyes	\$ 83.71
6	N73255	1	Rear Urethane Bush Kit- Spring Front eyes/shackle	\$ 110.28
7	UBL-06	4	Rear U-Bolts	\$ 24.61
8	LGSK386/3	2	Rear Greasable Shackle Kit	\$ 53.93
9	LGPK387-2	2	Rear Pin Kit (Non Greasable)	\$ 47.08
10	64610087A	2	Front Gas Legend Strut	\$ 331.29
11	64612525	2	Rear Gas Legend Shock Absorber	\$ 269.66

SUSPENSION KITS

Kit Type	Part No.	Qty. per vehicle	Kit Description	List Price EACH
B	TOYKIT070-B	1	RAISED	\$ 3,240.46
C	TOYKIT070-C	1	RAISED HEAVY DUTY	\$ 3,513.00

Optional parts

Item	Part No.	Qty. per vehicle	Option Description	List Price EACH
1A	LOVUCA-HIL	1	Lovells Extreme Upper Control Arm kit	\$ 920.00

ACCESSORIES (Not included in Kit)

Item	Part No.	Qty. per vehicle	Accessory Description	List Price EACH
1A	LSPV001	1	Extension Nut for Load Sensing Pressure Valve	\$ 25.17
2A	N48000	2	Front Strut Top Mount Assembly	\$ 94.31
3A	SBS-001	1	Front Sway Bar Spacer Kit	\$ 105.90
4A	HCEB002	2	Rear Handbrake Cable Extension Bracket	\$ 27.69

Highlighted Accessories: Lovells strongly recommend fitting this OPTION in all applications.

ITEM 1A- Refer Page 147 for Tech Bulletin

NOTE: Lovells front coil springs will not fit struts with a rolled lower spring seat. For correct fitment always use with a Lovells strut.

Part No.	Load Rating	Description
All spring load ratings are an approximate only. Vehicle ride heights will vary depending on load and accessories fitted.		
TFR-118	0 to 100kg Constant Load	Suits Steel Bull Bar
TFR-118HD	100 to 150kg Constant Load	Suits Steel Bull Bar, Winch, Underbody Protection etc.
TFR-118EHD	150 to 200kg Constant Load	Suits Steel Bull Bar, Winch, Underbody Protection etc.
TL-60	0 to 100kg Constant Load	
TL-60HD	150 to 250kg Constant Load	

TOYOTA- Hilux
GGN25R, KUN26R (150 Series) Single Cab, Dual Cab & Xtra Cab
3/05-9/15
Coil/Leaf

3300KG GVM Upgrade Kit (Fitted Price)- State Compliance

KIT COMPONENTS

Item	Part No.	Qty. per vehicle	Description	SOLD AS KIT ONLY
1	TFR-118HD	2	Front Coil Springs- GVM UPGRADE (GVM)	
2	TL-60EHD	2	Rear Leaf Springs- GVM UPGRADE (GVM)	
3	N73254	1	Rear Urethane Kit- Spring Front Eyes	
4	N73255	1	Rear Urethane Kit- Spring Rear Eyes and Shackles	
5	UBL-06	4	Rear U-Bolts	
6	LGSK386/3	2	Rear Greasable Shackle Kit	
7	LGPK387-2	2	Rear Pin Kit	
8	64610087A	2	Front Gas Legend Strut	
9	64612525	2	Rear Gas Legend Shock Absorber	
10	LSPV001	1	Extension Nut for Load Sensing Pressure Valve	
11		1	3300kg Compliance Plate	
12		1	Re-Tension U-Bolts Warning (Decal)	
13		2	Lovells Mudflaps	
14		1	3300kg Tyre Loading Placard (Decal)	
15		1	Owners Manual	
16		1	GVM Upgrade Fitting Instructions	

SUSPENSION KITS

Kit Type	Part No.	Qty. per vehicle	Kit Description	Retail Price
GVM	TOYKIT073-GVM-ST	1	GVM Upgrade Kit (Fitted Price)	\$ 5,200.00

NOTE: Lovells front coil springs will not fit struts with a rolled lower spring seat. For correct fitment always use with a Lovells strut.
 NOTE: Fitted Price plus GST

Optional parts

Item	Part No.	Qty. per vehicle	Option Description	List Price EACH
1A	LOVUCA-HIL	1	Lovells Extreme Upper Control Arm kit	\$ 920.00

Part No.	Load Rating	Description
All spring load ratings are an approximate only. Vehicle ride heights will vary depending on load and accessories fitted.		
TFR-118HD	100 to 150kg Constant Load	Suits Steel Bull Bar, Winch, Underbody Protection etc.
TL-60EHD	400 to 500kg Constant Load	To GVM

***NOTE: The above GVM Upgrade Kit for Federal Compliance under Second Stage Manufacturer Approval, with a Federal compliance plate, is no longer available
 The above kit can still be supplied under State Compliance and will require inspection, by a Lovells endorsed signatory and /or Production Facility.
 Consult your nearest Lovells Production facility for Individual State requirements.

TECHNICAL BULLETIN

P/N LSPV001– Extension Nut LSPV Adjustment

Subject: TOYOTA HILUX 150 Series Build date: 3/05 on - Brake Bias
 Revision A- 18th November 2008

Lovells Springs Pty Ltd publish this information in order to maintain safety standards and to assist in correct application and performance of Lovells products.

When fitting Lovells Raised or Raised H/Duty rear leaf springs to Toyota Hilux, it is essential to adjust the LSPV (Load Sensing Pressure Valve) if fitted to ensure correct braking performance.

The connecting link at standard height with Original Equipment rear leaf springs is 160mm (measured from the centre of the eye to the bracket on the valve). When raised rear leaf springs are fitted, this needs to be lengthened to 200mm.

Prior to fitment



Adjustment

LSPV001



LSPV001 Fitted

1. Disconnect the LSPV link from the vehicle. Reusing the existing nut as a lock nut, fit the Extension Nut (LSPV001).
2. Adjust the Extension Nut until the overall length measures 200mm, from the centre of the eye to the end of the link.
3. Re-fit the link to the vehicle.

Lovells strongly recommend that this part number be fitted when using Raised or Raised Heavy Duty rear leaf springs.

Brake line pressure testing and brake inertia testing must be performed after fitment of this part number to ensure correct braking performance.

Brake line Pressures after fitting:

Front: 9,000 kPa

Rear: 8,000 kPa

Brake testing (line pressures and inertia) should be performed with vehicle loaded.

TOYOTA- Hilux
GUN126R Single Cab, Dual Cab, Extra Cab (Diesel)
10/15 on
Coil/Leaf

KIT COMPONENTS

Item	Part No.	Qty. per vehicle	Description	List Price EACH
1	TFR-118	2	Front Coil Springs- Raised (B)	\$ 126.26
2	TFR-118HD	2	Front Coil Springs- Raised Heavy Duty (C)	\$ 126.26
3	TL-62	2	Rear Leaf Springs- Raised (B)	\$ 731.42
4	TL-62HD	2	Rear Leaf Springs- Raised Heavy Duty (C)	\$ 822.84
5	N73254	1	Rear Urethane Bush Kit- Spring Front eyes	\$ 83.71
6	N73255	1	Rear Urethane Bush Kit- Spring Rear eyes/shackle	\$ 110.28
7	UBL-06	4	Rear U-Bolts	\$ 24.61
8	LGSK392R	2	Rear Greasable Shackle Kit	\$ 84.91
9	LGPK387-2	2	Rear Pin Kit (Non Greasable)	\$ 47.08
10	64610087A	2	Front Gas Legend Strut	\$ 331.29
11	64612525	2	Rear Gas Legend Shock Absorber	\$ 269.66

SUSPENSION KITS

Kit Type	Part No.	Qty. per vehicle	Kit Description	List Price EACH
B	TOYKIT076-B	1	RAISED	\$ 3,473.66
C	TOYKIT076-C	1	RAISED HEAVY DUTY	\$ 3,656.52

Optional parts

Item	Part No.	Qty. per vehicle	Option Description	List Price EACH
1A	LOVUCA-HIL	1	Lovells Extreme Upper Control Arm kit	\$ 920.00

ACCESSORIES (Not included in Kit)

Item	Part No.	Qty. per vehicle	Accessory Description	List Price EACH
1A	CH002	1	Rear Brake Line Extension Kit	\$ 29.41
2A	HLAR001	1	Headlight Adjusting rod (SR5 only)	\$ 62.94
3A	SBS-002	1	Front Sway Bar Spacer Kit	\$ 105.90

ITEM 1A & 2A- Refer Page 142, 143 for Tech Bulletin

NOTE: Lovells front coil springs will not fit struts with a rolled lower spring seat. For correct fitment always use with a Lovells strut.

Part No.	Load Rating	Description
All spring load ratings are an approximate only. Vehicle ride heights will vary depending on load and accessories fitted.		
TFR-118	0 to 100kg Constant Load	Suits Steel Bull Bar
TFR-118HD	100 to 150kg Constant Load	Suits Steel Bull Bar, Winch, Underbody Protection etc.
TL-62	0 to 100kg Constant Load	
TL-62HD	150 to 250kg Constant Load	

TOYOTA- Hilux
GUN126R Single Cab, Dual Cab & Xtra Cab (Diesel)
10/15 on
Coil/Leaf

3500KG GVM Upgrade Kit (Fitted Price)-Federal Compliance

KIT COMPONENTS

Item	Part No.	Qty. per vehicle	Description	SOLD AS KIT ONLY
1	TFR-118	2	Front Coil Springs- GVM UPGRADE (GVM)	
2	TL-62EHD	2	Rear Leaf Springs- GVM UPGRADE (GVM)	
5	N73254	1	Rear Urethane Bush Kit- Spring Front eyes	
6	N73255	1	Rear Urethane Bush Kit- Spring Rear eyes/shackle	
7	UBL-06	4	Rear U-Bolts	
8	LGSK392R	2	Rear Greasable Shackle Kit	
9	LGPK387-2	2	Rear Pin Kit (Non Greasable)	
10	64610087A	2	Front Gas Legend Strut	
11	64612525	2	Rear Gas Legend Shock Absorber	
12		1	3500kg Compliance Plate	
13		1	Re-Tension U-Bolts Warning (Decal)	
14		2	Lovells Mudflaps	
15		1	3500kg Tyre Loading Placard (Decal)	
16		1	Owners Manual	
17		1	GVM Upgrade Fitting Instructions	

SUSPENSION KITS

Kit Type	Part No.	Qty. per vehicle	Kit Description	Retail Price
GVM	TOYKIT077-GVM	1	GVM Upgrade Kit (Fitted Price)	\$ 5,200.00

Optional parts

Item	Part No.	Qty. per vehicle	Option Description	List Price EACH
1A	LOVUCA-HIL	1	Lovells Extreme Upper Control Arm kit	\$ 920.00

ACCESSORIES (Not included in Kit)

Item	Part No.	Qty. per vehicle	Accessory Description	List Price EACH
1A	CH002	1	Rear Brake Line Extension Kit	\$ 29.41
2A	HLAR001	1	Headlight Adjusting rod (SR5 only)	\$ 62.94
3A	SBS-002	1	Front Sway Bar Spacer Kit	\$ 105.90

NOTE: Lovells front coil springs will not fit struts with a rolled lower spring seat. For correct fitment always use with a Lovells strut.

The solution for owners/managers of Toyota Hilux GUN126R 4x4 vehicles who have a need to carry loads to a GVM of 3500kg (up from 3000kg standard GVM), while at the same time meeting the practical and documentary compliance requirements of Work Safety, Police Licensing, Insurance, Lessors and Fleet Managers.

This kit is complied by Department of Infrastructure and Transport and comes complete with a Second Stage Manufacturer compliance plate. (Australian Compliance ONLY)

Lovells Compliance Plate Approval Number (CPA) 47909

Note: Above price is net and no discounts apply. Lovells Authorised Fitters (holding Production Facility ID) are entitled to a Fitters Price. (Available upon application)

Above price includes fitting by a Lovells Authorised Fitter and does not include GST
*****NOTE: The above GVM Upgrade can be supplied under State Compliance (for already registered vehicles) and the vehicle individually engineered for the State of registration. Includes State engineering certificate or certification plate. Kit part numbers, order forms, details and pricing are available upon application**

Part No.	Load Rating	Description
All spring load ratings are an approximate only. Vehicle ride heights will vary depending on load and accessories fitted.		
TFR-118	0 to 100kg Constant Load	Suits Steel Bull Bar
TL-62EHD	400 to 500kg Constant Load	To GVM

TECHNICAL BULLETIN P/N CH002– Rear Brake Line Spacer

Subject: TOYOTA HILUX GUN126R Series Build date: 10/15 on
 1st May 2016

Lovells Springs Pty Ltd publish this information in order to maintain safety standards and to assist in correct application and performance of Lovells products.

When fitting Lovells Raised or Raised H/Duty rear leaf springs to Toyota Hilux, it is essential to fit a brake line spacer to ensure the brake line is not over extended. A simple kit has been developed that raises the mounting point of the flexible brake hose coupling sufficiently to allow safe fitment of raised leaf springs.



CH002 Spacer



CH002 Fitted

1. Remove original bolt from brake line bracket on differential housing (passenger side) and fit spacer between bracket and differential housing using new bolt supplied.
2. You will need to slightly bend metal tab on bracket to align correctly.

TECHNICAL BULLETIN
P/N HLAR001– Headlight Potentiometer Link Adjustment

Subject: TOYOTA HILUX GUN126R SR5 Build date: 10/15 on

Lovells Springs Pty Ltd publish this information in order to maintain safety standards and to assist in correct application and performance of Lovells products.

When fitting Lovells Raised or Raised H/Duty rear leaf springs to Toyota Hilux, it is essential to adjust the headlight trim link to the potentiometer which is located between the Passengers Side rear leaf spring and the shackle.



Original Equipment

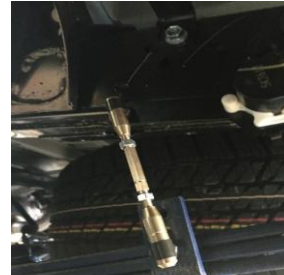

HLAR001 Fitted

SR5 Models only.

Must be performed on a level surface, preferably on a four post hoist.

1. With the new springs installed, remove the Original Equipment link from the potentiometer arm and fit new HLAR001 as per above image.
2. Adjust HLAR001 so the arm on the potentiometer is parallel with the ground or 0 degrees with a protractor.
3. When adjustment is correct, tighten lock nuts on turn buckle link adjuster.

TOYOTA- Hilux
2WD (4x2) GEN 8 Dual Cab & Xtra Cab
10/15 on
Coil/Leaf

3500KG GVM Upgrade Kit (Fitted Price)-State Compliance

KIT COMPONENTS

Item	Part No.	Qty. per vehicle	Description	SOLD AS KIT ONLY
1	TFR-118	2	Front Coil Springs- GVM UPGRADE (GVM)	
2	TL-62EHD	2	Rear Leaf Springs- GVM UPGRADE (GVM)	
5	N73254	1	Rear Urethane Bush Kit- Spring Front eyes	
6	N73255	1	Rear Urethane Bush Kit- Spring Rear eyes/shackle	
7	UBL-06	4	Rear U-Bolts	
8	LGSK392R	2	Rear Greasable Shackle Kit	
9	LGPK387-2	2	Rear Pin Kit (Non Greasable)	
10	64610087A	2	Front Gas Legend Strut	
11	64612525	2	Rear Gas Legend Shock Absorber	
12		1	3500kg Compliance Plate	
13		1	Re-Tension U-Bolts Warning (Decal)	
14		2	Lovells Mudflaps	
15		1	3500kg Tyre Loading Placard (Decal)	
16		1	Owners Manual	
17		1	GVM Upgrade Fitting Instructions	

SUSPENSION KITS

Kit Type	Part No.	Qty. per vehicle	Kit Description	Retail Price
GVM	TOYKIT082-GVM	1	GVM Upgrade Kit (Fitted Price)	\$ 5,000.00

NOTE: Fitted Price plus GST

ACCESSORIES (Not included in Kit)

Item	Part No.	Qty. per vehicle	Accessory Description	List Price EACH
1A	CH002	1	Rear Brake Line Extension Kit	\$ 29.41
2A	HLAR001	1	Headlight Adjusting rod (SR5 only)	\$ 62.94
3A	SBS-002	1	Front Sway Bar Spacer Kit	\$ 105.90

NOTE: Lovells front coil springs will not fit struts with a rolled lower spring seat. For correct fitment always use with a Lovells strut.

Part No.	Load Rating	Description
All spring load ratings are an approximate only. Vehicle ride heights will vary depending on load and accessories fitted.		
TFR-118	0 to 100kg Constant Load	Suits Steel Bull Bar
TL-62EHD	400 to 500kg Constant Load	To GVM

***NOTE: The above GVM Upgrade Kit for Federal Compliance under Second Stage Manufacturer Approval, with a Federal compliance plate, is no longer available
The above kit can still be supplied under State Compliance and will require inspection, by a Lovells endorsed signatory and /or Production Facility.
Consult your nearest Lovells Production facility for Individual State requirements.

TOYOTA- Landcruiser 40 Series
BJ, FJ, HJ40 SWB
3/59-7/80
Leaf/Leaf



KIT COMPONENTS

Item	Part No.	Qty. per vehicle	Description	List Price EACH
1	TL-1	2	Front Leaf Springs- Raised (B)	\$ 575.33
2	TL-1HD	2	Front Leaf Springs- Raised Heavy Duty (C)	\$ 586.88
3	TL-2	2	Rear Leaf Springs- Raised (B)	\$ 416.57
4	TL-16	2	Rear Leaf Springs- Raised Heavy Duty (C)	\$ 478.22
5	N71059	1	Front Urethane Kit- Spring Front/Rear eyes/Shackle	\$ 106.22
6	N71059	1	Rear Urethane Kit- Spring Front/Rear eyes/Shackle	\$ 106.22
7	UBL-04	4	Front U-Bolts	\$ 24.61
8	UBL-04	4	Rear U-Bolts	\$ 24.61
9	LGSK343	2	Front Greasable Shackle	\$ 53.93
10	LGPK346	2	Front Greasable Pin	\$ 40.13
11	LGSK343	2	Rear Greasable Shackle	\$ 53.93
12	LGPK346	2	Rear Greasable Pin	\$ 40.13
13	64612540	2	Front Gas Legend Shock Absorber	\$ 244.03
14	64612540	2	Rear Gas Legend Shock Absorber	\$ 244.03

SUSPENSION KITS

Kit Type	Part No.	Qty. per vehicle	Kit Description	List Price EACH
B	TOYKIT014-B	1	RAISED	\$ 3,745.43
C	TOYKIT014-C	1	RAISED HEAVY DUTY	\$ 3,891.84

ACCESSORIES (Not included in Kit)

Item	Part No.	Qty. per vehicle	Accessory Description	List Price EACH
1A	LGSKGASP-009L/H	1	Front P/Side- Anti Inversion Greasable Shackle	\$ 96.30
2A	LGSKGASP-009R/H	1	Front D/Side- Anti Inversion Greasable Shackle	\$ 96.30
3A	LGSKGASP-009L/H	1	Rear P/Side- Anti Inversion Greasable Shackle	\$ 96.30
4A	LGSKGASP-009R/H	1	Rear D/Side- Anti Inversion Greasable Shackle	\$ 96.30

Part No.	Load Rating	Description
All spring load ratings are an approximate only. Vehicle ride heights will vary depending on load and accessories fitted.		
TL-1	0 to 100kg Constant Load	Suits Steel Bull Bar
TL-1HD	150 to 250kg Constant Load	Suits Steel Bull Bar, Winch, Underbody Protection etc.
TL-2	0 to 100kg Constant Load	
TL-16	150 to 250kg Constant Load	

TOYOTA- Landcruiser 40, 42, 46 Series
BJ, FJ40, BJ42, 46 SWB
8/80-4/86
Leaf/Leaf



KIT COMPONENTS

Item	Part No.	Qty. per vehicle	Description	List Price EACH
1	TL-11	2	Front Leaf Springs- Raised (B)	\$ 521.47
2	TL-11HD	2	Front Leaf Springs- Raised Heavy Duty (C)	\$ 639.99
3	TL-12	2	Rear Leaf Springs- Raised (B)	\$ 484.51
4	TL-12HD	2	Rear Leaf Springs- Raised Heavy Duty (C)	\$ 562.07
5	N71042	1	Front Urethane Kit- Spring Front/Rear eyes/Shackle	\$ 129.88
6	N71042	1	Rear Urethane Kit- Spring Front/Rear eyes/Shackle	\$ 129.88
7	UBL-04	3	Front U-Bolts	\$ 24.61
8	UBL-449	1	Front U-Bolt- D/S Front	\$ 24.61
9	UBL-09	4	Rear U-Bolts	\$ 24.61
10	LGSK348	2	Front Greasable Shackle	\$ 53.93
11	LGPK351	2	Front Greasable Pin	\$ 40.13
12	LGSK349L/H	1	Rear Greasable Shackle	\$ 53.93
13	LGSK350R/H	1	Rear Greasable Shackle	\$ 53.93
14	LGPK351	2	Rear Greasable Pin	\$ 40.13
15	64612540	2	Front Gas Legend Shock Absorber	\$ 244.03
16	6462258B	2	Rear Gas Legend Shock Absorber	\$ 269.38

SUSPENSION KITS

Kit Type	Part No.	Qty. per vehicle	Kit Description	List Price EACH
B	TOYKIT015-B	1	RAISED	\$ 3,871.63
C	TOYKIT015-C	1	RAISED HEAVY DUTY	\$ 4,263.79

ACCESSORIES (Not included in Kit)

Item	Part No.	Qty. per vehicle	Accessory Description	List Price EACH
1A	LGSKGASP-002L/H	1	Front P/Side- Anti Inversion Greasable Shackle	\$ 96.30
2A	LGSKGASP-002R/H	1	Front D/Side- Anti Inversion Greasable Shackle	\$ 96.30
3A	LGSKGASP-001L/H	1	Rear P/Side- Anti Inversion Greasable Shackle	\$ 77.04
4A	LGSKGASP-001R/H	1	Rear D/Side- Anti Inversion Greasable Shackle	\$ 77.04

Part No.	Load Rating	Description
All spring load ratings are an approximate only. Vehicle ride heights will vary depending on load and accessories fitted.		
TL-11	0 to 100kg Constant Load	Suits Steel Bull Bar
TL-11HD	100 to 150kg Constant Load	Suits Steel Bull Bar, Winch, Underbody Protection etc.
TL-12	0 to 100kg Constant Load	
TL-12HD	150 to 250kg Constant Load	

TOYOTA- Landcruiser 45 Series
FJ45, HJ45 Tray Back
3/69-7/80
Leaf/Leaf

KIT COMPONENTS

Item	Part No.	Qty. per vehicle	Description	List Price EACH
1	TL-1	2	Front Leaf Springs- Raised (B)	\$ 575.33
2	TL-1HD	2	Front Leaf Springs- Raised Heavy Duty (C)	\$ 586.88
3	TL-5	2	Rear Leaf Springs- Raised (B)	\$ 897.14
4	TL-5HD	2	Rear Leaf Springs- Raised Heavy Duty (C)	\$ 994.93
5	N71059	1	Front Urethane Kit- Spring Front/Rear eyes/Shackle	\$ 106.22
6	N71074	1	Rear Urethane Kit- Spring Front/Rear eyes/Shackle	\$ 129.25
7	UBL-04	4	Front U-Bolts	\$ 24.61
8	UBL-09	4	Rear U-Bolts	\$ 24.61
9	LGSK343	2	Front Greasable Shackle	\$ 53.93
10	LGPK346	2	Front Greasable Pin	\$ 40.13
11	LGSK345L/H	1	Rear Greasable Shackle	\$ 47.04
12	LGSK344R/H	1	Rear Greasable Shackle	\$ 47.04
13	LGPK347	2	Rear Greasable Pin	\$ 40.13
14	64612540	2	Front Gas Legend Shock Absorber	\$ 244.03
15	6462258B	2	Rear Gas Legend Shock Absorber	\$ 269.38

SUSPENSION KITS

Kit Type	Part No.	Qty. per vehicle	Kit Description	List Price EACH
B	TOYKIT016-B	1	RAISED	\$ 4,766.54
C	TOYKIT016-C	1	RAISED HEAVY DUTY	\$ 4,985.22

ACCESSORIES (Not included in Kit)

Item	Part No.	Qty. per vehicle	Accessory Description	List Price EACH
1A	N22107	1	Rear Urethane Bush Kit- Sway Bar Outer Link	\$ 39.48

Part No.	Load Rating	Description
All spring load ratings are an approximate only. Vehicle ride heights will vary depending on load and accessories fitted.		
TL-1	0 to 100kg Constant Load	Suits Steel Bull Bar
TL-1HD	150 to 250kg Constant Load	Suits Steel Bull Bar, Winch, Underbody Protection etc.
TL-5	0 to 100kg Constant Load	
TL-5HD	150 to 250kg Constant Load	

TOYOTA- Landcruiser 45 Series
FJ45, HJ45 Troop Carrier
3/69-7/80
Leaf/Leaf

KIT COMPONENTS

Item	Part No.	Qty. per vehicle	Description	List Price EACH
1	TL-1	2	Front Leaf Springs- Raised (B)	\$ 575.33
3	TL-13	2	Rear Leaf Springs- Raised (B)	\$ 1,035.36
5	N71059	1	Front Urethane Kit- Spring Front/Rear eyes/Shackle	\$ 106.22
6	N71074	1	Rear Urethane Kit- Spring Front/Rear eyes/Shackle	\$ 129.25
7	UBL-04	4	Front U-Bolts	\$ 24.61
8	UBL-09	4	Rear U-Bolts	\$ 24.61
9	LGSK343	2	Front Greasable Shackle	\$ 53.93
10	LGPK346	2	Front Greasable Pin	\$ 40.13
11	LGSK345L/H	1	Rear Greasable Shackle	\$ 47.04
12	LGSK344R/H	1	Rear Greasable Shackle	\$ 47.04
13	LGPK347	2	Rear Greasable Pin	\$ 40.13
14	64612540	2	Front Gas Legend Shock Absorber	\$ 244.03
15	6462258B	2	Rear Gas Legend Shock Absorber	\$ 269.38

SUSPENSION KITS

Kit Type	Part No.	Qty. per vehicle	Kit Description	List Price EACH
B	TOYKIT017-B	1	RAISED	\$ 5,042.98

ACCESSORIES (Not included in Kit)

Item	Part No.	Qty. per vehicle	Accessory Description	List Price EACH
1A	N22107	1	Rear Urethane Bush Kit- Sway Bar Outer Link	\$ 39.48

Part No.	Load Rating	Description
All spring load ratings are an approximate only. Vehicle ride heights will vary depending on load and accessories fitted.		
TL-1	0 to 100kg Constant Load	Suits Steel Bull Bar
TL-13	0 to 100kg Constant Load	

TOYOTA- Landcruiser 45, 47 Series
FJ45, HJ47 Tray Back
8/80-4/86
Leaf/Leaf

KIT COMPONENTS

Item	Part No.	Qty. per vehicle	Description	List Price EACH
1	TL-11	2	Front Leaf Springs- Raised (B)	\$ 521.47
2	TL-11HD	2	Front Leaf Springs- Raised Heavy Duty (C)	\$ 639.99
3	TL-14	2	Rear Leaf Springs- Raised (B)	\$ 1,039.44
4	TL-14HD	2	Rear Leaf Springs- Raised Heavy Duty (C)	\$ 1,132.69
5	N71042	1	Front Urethane Kit- Spring Front/Rear eyes/Shackle	\$ 129.88
6	N71042	1	Rear Urethane Kit- Spring Front/Rear eyes/Shackle	\$ 129.88
7	UBL-04	3	Front U-Bolts	\$ 24.61
8	UBL-449	1	Front U-Bolt- D/S Front	\$ 24.61
9	UBL-09	4	Rear U-Bolts	\$ 24.61
10	LGSK348	2	Front Greasable Shackle	\$ 53.93
11	LGPK351	2	Front Greasable Pin	\$ 40.13
12	LGSK349L/H	1	Rear Greasable Shackle	\$ 53.93
13	LGSK350R/H	1	Rear Greasable Shackle	\$ 53.93
14	LGPK351	2	Rear Greasable Pin	\$ 40.13
15	64612540	2	Front Gas Legend Shock Absorber	\$ 244.03
16	6462258B	2	Rear Gas Legend Shock Absorber	\$ 269.38

SUSPENSION KITS

Kit Type	Part No.	Qty. per vehicle	Kit Description	List Price EACH
B	TOYKIT018-B	1	RAISED	\$ 4,981.49
C	TOYKIT018-C	1	RAISED HEAVY DUTY	\$ 5,405.03

ACCESSORIES (Not included in Kit)

Item	Part No.	Qty. per vehicle	Accessory Description	List Price EACH
1A	LGSKGASP-002L/H	1	Front P/Side- Anti Inversion Greasable Shackle	\$ 96.30
2A	LGSKGASP-002R/H	1	Front D/Side- Anti Inversion Greasable Shackle	\$ 96.30
3A	LGSKGASP-001L/H	1	Rear P/Side- Anti Inversion Greasable Shackle	\$ 77.04
4A	LGSKGASP-001R/H	1	Rear D/Side- Anti Inversion Greasable Shackle	\$ 77.04

Part No.	Load Rating	Description
All spring load ratings are an approximate only. Vehicle ride heights will vary depending on load and accessories fitted.		
TL-11	0 to 100kg Constant Load	Suits Steel Bull Bar
TL-11HD	100 to 150kg Constant Load	Suits Steel Bull Bar, Winch, Underbody Protection etc.
TL-14	0 to 100kg Constant Load	
TL-14HD	150 to 250kg Constant Load	

TOYOTA- Landcruiser 45, 47 Series
FJ45, HJ47 Troop Carrier
8/80-4/86
Leaf/Leaf

KIT COMPONENTS

Item	Part No.	Qty. per vehicle	Description	List Price EACH
1	TL-11	2	Front Leaf Springs- Raised (B)	\$ 521.47
2	TL-11HD	2	Front Leaf Springs- Raised Heavy Duty (C)	\$ 639.99
3	TL-14	2	Rear Leaf Springs- Raised (B)	\$ 1,039.44
4	TL-14HD	2	Rear Leaf Springs- Raised Heavy Duty (C)	\$ 1,132.69
5	N71042	1	Front Urethane Kit- Spring Front/Rear eyes/Shackle	\$ 129.88
6	N71042	1	Rear Urethane Kit- Spring Front/Rear eyes/Shackle	\$ 129.88
7	UBL-04	3	Front U-Bolts	\$ 24.61
8	UBL-449	1	Front U-Bolt- D/S Front	\$ 24.61
9	UBL-09	4	Rear U-Bolts	\$ 24.61
10	LGSK348	2	Front Greasable Shackle	\$ 53.93
11	LGPK351	2	Front Greasable Pin	\$ 40.13
12	LGSK349L/H	1	Rear Greasable Shackle	\$ 53.93
13	LGSK350R/H	1	Rear Greasable Shackle	\$ 53.93
14	LGPK351	2	Rear Greasable Pin	\$ 40.13
15	64612540	2	Front Gas Legend Shock Absorber	\$ 244.03
16	6462258B	2	Rear Gas Legend Shock Absorber	\$ 269.38

SUSPENSION KITS

Kit Type	Part No.	Qty. per vehicle	Kit Description	List Price EACH
B	TOYKIT019-B	1	RAISED	\$ 4,981.49
C	TOYKIT019-C	1	RAISED HEAVY DUTY	\$ 5,405.03

ACCESSORIES (Not included in Kit)

Item	Part No.	Qty. per vehicle	Accessory Description	List Price EACH
1A	LGSKGASP-002L/H	1	Front P/Side- Anti Inversion Greasable Shackle	\$ 96.30
2A	LGSKGASP-002R/H	1	Front D/Side- Anti Inversion Greasable Shackle	\$ 96.30
3A	LGSKGASP-001L/H	1	Rear P/Side- Anti Inversion Greasable Shackle	\$ 77.04
4A	LGSKGASP-001R/H	1	Rear D/Side- Anti Inversion Greasable Shackle	\$ 77.04

Part No.	Load Rating	Description
All spring load ratings are an approximate only. Vehicle ride heights will vary depending on load and accessories fitted.		
TL-11	0 to 100kg Constant Load	Suits Steel Bull Bar
TL-11HD	100 to 150kg Constant Load	Suits Steel Bull Bar, Winch, Underbody Protection etc.
TL-14	0 to 100kg Constant Load	
TL-14HD	150 to 250kg Constant Load	

TOYOTA- Landcruiser 55 Series
FJ55 Wagon
11/72-7/80
Leaf/Leaf

KIT COMPONENTS

Item	Part No.	Qty. per vehicle	Description	List Price EACH
1	TL-3	2	Front Leaf Springs- Raised (B)	\$ 501.77
2	TL-3HD	2	Front Leaf Springs- Raised Heavy Duty (C)	\$ 501.77
3	TL-4	2	Rear Leaf Springs- Raised (B)	\$ 708.56
4	TL-4HD	2	Rear Leaf Springs- Raised Heavy Duty (C)	\$ 875.59
5	N71074	1	Front Urethane Kit- Spring Front/Rear eyes/Shackle	\$ 129.25
6	N71074	1	Rear Urethane Kit- Spring Front/Rear eyes/Shackle	\$ 129.25
7	UBL-04	4	Front U-Bolts	\$ 24.61
8	UBL-09	4	Rear U-Bolts	\$ 24.61
9	LGSK344-1	2	Front Greasable Shackle	\$ 53.93
10	LGPK653	2	Front Greasable Pin	\$ 47.08
11	LGSK345-1	2	Rear Greasable Shackle	\$ 53.93
12	LGPK653	2	Rear Greasable Pin	\$ 47.08
13	64612639S	2	Front Gas Legend Shock Absorber	\$ 227.70
14	64612636	2	Rear Gas Legend Shock Absorber	\$ 244.03

SUSPENSION KITS

Kit Type	Part No.	Qty. per vehicle	Kit Description	List Price EACH
B	TOYKIT020-B	1	RAISED	\$ 4,223.53
C	TOYKIT020-C	1	RAISED HEAVY DUTY	\$ 4,557.59

Part No.	Load Rating	Description
All spring load ratings are an approximate only. Vehicle ride heights will vary depending on load and accessories fitted.		
TL-3	0 to 100kg Constant Load	Suits Steel Bull Bar
TL-3HD	150 to 250kg Constant Load	Suits Steel Bull Bar, Winch, Underbody Protection etc.
TL-4	0 to 100kg Constant Load	
TL-4HD	150 to 250kg Constant Load	

TOYOTA- Landcruiser 60 Series
HJ60 Wagon (Diesel)- 2H Engine non-turbo
8/80-6/87
Leaf/Leaf



KIT COMPONENTS

Item	Part No.	Qty. per vehicle	Description	List Price EACH
1	TL-22SH	2	Front Leaf Springs- Standard Height (A)	\$ 520.09
2	TL-22	2	Front Leaf Springs- Raised (B)	\$ 520.09
3	TL-22HD	2	Front Leaf Springs- Raised Heavy Duty (C)	\$ 600.26
4	TL-31	2	Rear Leaf Springs- Standard Height (A)	\$ 597.82
5	TL-21	2	Rear Leaf Springs- Raised (B)	\$ 601.55
6	TL-27	2	Rear Leaf Springs- Raised Heavy Duty (C)	\$ 873.12
7	N71042	1	Front Urethane Kit- Spring Front/Rear eyes/Shackle	\$ 129.88
8	N71042	1	Rear Urethane Kit- Spring Front/Rear eyes/Shackle	\$ 129.88
9	UBL-08	4	Front U-Bolts	\$ 24.61
10	UBL-04	4	Rear U-Bolts	\$ 24.61
11	LGSK348	2	Front Greasable Shackle	\$ 53.93
12	LGPK351	2	Front Greasable Pin	\$ 40.13
13	LGSK352	2	Rear Greasable Shackle	\$ 53.93
14	LGPK351	2	Rear Greasable Pin	\$ 40.13
15	64612572	2	Front Gas Legend Shock Absorber	\$ 244.03
16	6462258B	2	Rear Gas Legend Shock Absorber	\$ 269.38
	(8/80-10/85 build date)			
17	64612525	2	Rear Gas Legend Shock Absorber	\$ 269.66
	(10/85-6/87 build date)			

SUSPENSION KITS

Kit Type	Part No.	Qty. per vehicle	Kit Description	List Price EACH
A	TOYKIT021-A	1	STANDARD HEIGHT	\$ 4,095.49
B	TOYKIT021-B	1	RAISED	\$ 4,102.95
C	TOYKIT021-C	1	RAISED HEAVY DUTY	\$ 4,806.43

ACCESSORIES (Not included in Kit)

Item	Part No.	Qty. per vehicle	Accessory Description	List Price EACH
1A	LGSKGASP-002L/H	1	Front P/Side- Anti Inversion Greasable Shackle	\$ 96.30
2A	LGSKGASP-002R/H	1	Front D/Side- Anti Inversion Greasable Shackle	\$ 96.30
3A	LGSKGASP-001L/H	1	Rear P/Side- Anti Inversion Greasable Shackle	\$ 77.04
4A	LGSKGASP-001R/H	1	Rear D/Side- Anti Inversion Greasable Shackle	\$ 77.04

Part No.	Load Rating	Description
All spring load ratings are an approximate only. Vehicle ride heights will vary depending on load and accessories fitted.		
TL-22SH	0 to 100kg Constant Load	Suits Steel Bull Bar
TL-22	0 to 100kg Constant Load	Suits Steel Bull Bar
TL-22HD	100 to 150kg Constant Load	Suits Steel Bull Bar, Winch, Underbody Protection etc.
TL-31	0 to 100kg Constant Load	
TL-21	0 to 100kg Constant Load	
TL-27	150 to 250kg Constant Load	

TOYOTA- Landcruiser 60 Series
HJ60 Wagon (Diesel)- 12H Engine Turbo
7/87-2/89
Leaf/Leaf

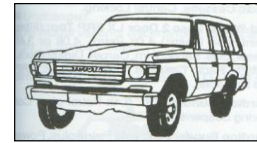

KIT COMPONENTS

Item	Part No.	Qty. per vehicle	Description	List Price EACH
1	TL-40	2	Front Leaf Springs- Raised (B)	\$ 534.96
2	TL-40HD	2	Front Leaf Springs- Raised Heavy Duty (C)	\$ 614.37
3	TL-41	2	Rear Leaf Springs- Raised (B)	\$ 865.01
4	TL-41HD	2	Rear Leaf Springs- Raised Heavy Duty (C)	\$ 966.85
5	N71042	1	Front Urethane Kit- Spring Front/Rear eyes/Shackle	\$ 129.88
6	N71042	1	Rear Urethane Kit- Spring Front/Rear eyes/Shackle	\$ 129.88
7	UBL-08	4	Front U-Bolts	\$ 24.61
8	UBL-04	4	Rear U-Bolts	\$ 24.61
9	LGSK348	2	Front Greasable Shackle	\$ 53.93
10	LGPK351	2	Front Greasable Pin	\$ 40.13
11	LGSK352	2	Rear Greasable Shackle	\$ 53.93
12	LGPK351	2	Rear Greasable Pin	\$ 40.13
13	64612572	2	Front Gas Legend Shock Absorber	\$ 244.03
14	64612525	2	Rear Gas Legend Shock Absorber	\$ 269.66

SUSPENSION KITS

Kit Type	Part No.	Qty. per vehicle	Kit Description	List Price EACH
B	TOYKIT022-B	1	RAISED	\$ 4,660.16
C	TOYKIT022-C	1	RAISED HEAVY DUTY	\$ 5,022.66

ACCESSORIES (Not included in Kit)

Item	Part No.	Qty. per vehicle	Accessory Description	List Price EACH
1A	LGSKGASP-002L/H	1	Front P/Side- Anti Inversion Greasable Shackle	\$ 96.30
2A	LGSKGASP-002R/H	1	Front D/Side- Anti Inversion Greasable Shackle	\$ 96.30
3A	LGSKGASP-001L/H	1	Rear P/Side- Anti Inversion Greasable Shackle	\$ 77.04
4A	LGSKGASP-001R/H	1	Rear D/Side- Anti Inversion Greasable Shackle	\$ 77.04

STEERING DAMPERS (Not included in Kit)

Item	Part No.	Qty. per vehicle	Description	List Price EACH
1B	5450011	1	Steering Damper Assembly- Heavy Duty	\$ 143.75
2B	5450011-RTC	1	Steering Damper Assembly- Return to Centre	\$ 201.67

Part No.	Load Rating	Description
All spring load ratings are an approximate only. Vehicle ride heights will vary depending on load and accessories fitted.		
TL-40	0 to 100kg Constant Load	Suits Steel Bull Bar
TL-40HD	150 to 250kg Constant Load	Suits Steel Bull Bar, Winch, Underbody Protection etc.
TL-41	0 to 100kg Constant Load	
TL-41HD	150 to 250kg Constant Load	

TOYOTA- Landcruiser 60 Series
FJ60 Wagon (Petrol)- 2F Engine
8/80-6/87
Leaf/Leaf

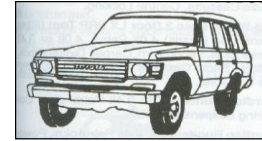

KIT COMPONENTS

Item	Part No.	Qty. per vehicle	Description	List Price EACH
1	TL-9SH	2	Front Leaf Springs- Standard Height (A)	\$ 418.37
2	TL-9	2	Front Leaf Springs- Raised (B)	\$ 417.69
3	TL-9HD	2	Front Leaf Springs- Raised Heavy Duty (C)	\$ 442.98
4	TL-31	2	Rear Leaf Springs- Standard Height (A)	\$ 597.82
5	TL-21	2	Rear Leaf Springs- Raised (B)	\$ 601.55
6	TL-27	2	Rear Leaf Springs- Raised Heavy Duty (C)	\$ 873.12
7	N71042	1	Front Urethane Kit- Spring Front/Rear eyes/Shackle	\$ 129.88
8	N71042	1	Rear Urethane Kit- Spring Front/Rear eyes/Shackle	\$ 129.88
9	UBL-08	4	Front U-Bolts	\$ 24.61
10	UBL-04	4	Rear U-Bolts	\$ 24.61
11	LGSK348	2	Front Greasable Shackle	\$ 53.93
12	LGPK351	2	Front Greasable Pin	\$ 40.13
13	LGSK352	2	Rear Greasable Shackle	\$ 53.93
14	LGPK351	2	Rear Greasable Pin	\$ 40.13
15	64612572	2	Front Gas Legend Shock Absorber	\$ 244.03
16	6462258B (8/80-10/85 build date)	2	Rear Gas Legend Shock Absorber	\$ 269.38
17	64612525 (10/85-6/87 build date)	2	Rear Gas Legend Shock Absorber	\$ 269.66

SUSPENSION KITS

Kit Type	Part No.	Qty. per vehicle	Kit Description	List Price EACH
A	TOYKIT023-A	1	STANDARD HEIGHT	\$ 3,892.05
B	TOYKIT023-B	1	RAISED	\$ 3,898.15
C	TOYKIT023-C	1	RAISED HEAVY DUTY	\$ 4,491.87

ACCESSORIES (Not included in Kit)

Item	Part No.	Qty. per vehicle	Accessory Description	List Price EACH
1A	LSGKGASP-002L/H	1	Front P/Side- Anti Inversion Greasable Shackle	\$ 96.30
2A	LSGKGASP-002R/H	1	Front D/Side- Anti Inversion Greasable Shackle	\$ 96.30
3A	LSGKGASP-001L/H	1	Rear P/Side- Anti Inversion Greasable Shackle	\$ 77.04
4A	LSGKGASP-001R/H	1	Rear D/Side- Anti Inversion Greasable Shackle	\$ 77.04

Part No.	Load Rating	Description
All spring load ratings are an approximate only. Vehicle ride heights will vary depending on load and accessories fitted.		
TL-9SH	0 to 100kg Constant Load	Suits Steel Bull Bar
TL-9	0 to 100kg Constant Load	Suits Steel Bull Bar
TL-9HD	150 to 250kg Constant Load	Suits Steel Bull Bar, Winch, Underbody Protection etc.
TL-31	0 to 100kg Constant Load	
TL-21	0 to 100kg Constant Load	
TL-27	150 to 250kg Constant Load	

TOYOTA- Landcruiser 60 Series
FJ60 Wagon (Petrol)- 3F Engine
7/87-2/89
Leaf/Leaf

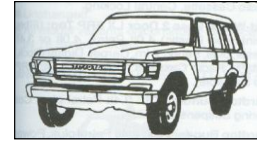

KIT COMPONENTS

Item	Part No.	Qty. per vehicle	Description	List Price EACH
1	TL-9	2	Front Leaf Springs- Raised (B)	\$ 417.69
2	TL-9HD	2	Front Leaf Springs- Raised Heavy Duty (C)	\$ 442.98
3	TL-41	2	Rear Leaf Springs- Raised (B)	\$ 865.01
4	TL-41HD	2	Rear Leaf Springs- Raised Heavy Duty (C)	\$ 966.85
5	N71042	1	Front Urethane Kit- Spring Front/Rear eyes/Shackle	\$ 129.88
6	N71042	1	Rear Urethane Kit- Spring Front/Rear eyes/Shackle	\$ 129.88
7	UBL-08	4	Front U-Bolts	\$ 24.61
8	UBL-04	4	Rear U-Bolts	\$ 24.61
9	LGSK348	2	Front Greasable Shackle	\$ 53.93
10	LGPK351	2	Front Greasable Pin	\$ 40.13
11	LGSK352	2	Rear Greasable Shackle	\$ 53.93
12	LGPK351	2	Rear Greasable Pin	\$ 40.13
13	64612572	2	Front Gas Legend Shock Absorber	\$ 244.03
14	64612525	2	Rear Gas Legend Shock Absorber	\$ 269.66

SUSPENSION KITS

Kit Type	Part No.	Qty. per vehicle	Kit Description	List Price EACH
B	TOYKIT024-B	1	RAISED	\$ 4,425.62
C	TOYKIT024-C	1	RAISED HEAVY DUTY	\$ 4,679.88

ACCESSORIES (Not included in Kit)

Item	Part No.	Qty. per vehicle	Accessory Description	List Price EACH
1A	LGSKGASP-002L/H	1	Front P/Side- Anti Inversion Greasable Shackle	\$ 96.30
2A	LGSKGASP-002R/H	1	Front D/Side- Anti Inversion Greasable Shackle	\$ 96.30
3A	LGSKGASP-001L/H	1	Rear P/Side- Anti Inversion Greasable Shackle	\$ 77.04
4A	LGSKGASP-001R/H	1	Rear D/Side- Anti Inversion Greasable Shackle	\$ 77.04

STEERING DAMPERS (Not included in Kit)

Item	Part No.	Qty. per vehicle	Description	List Price EACH
1B	5450011	1	Steering Damper Assembly- Heavy Duty	\$ 143.75
2B	5450011-RTC	1	Steering Damper Assembly- Return to Centre	\$ 201.67

Part No.	Load Rating	Description
All spring load ratings are an approximate only. Vehicle ride heights will vary depending on load and accessories fitted.		
TL-9	0 to 100kg Constant Load	Suits Steel Bull Bar
TL-9HD	150 to 250kg Constant Load	Suits Steel Bull Bar, Winch, Underbody Protection etc.
TL-41	0 to 100kg Constant Load	
TL-41HD	150 to 250kg Constant Load	

TOYOTA- Landcruiser 70, 73, 74 Series
BJ, FJ70,73,74 (Petrol and Diesel)
11/84-12/89
Leaf/Leaf

KIT COMPONENTS

Item	Part No.	Qty. per vehicle	Description	List Price EACH
1	TL-19	2	Front Leaf Springs- Raised (B)	\$ 464.14
2	TL-19MS	2	Front Leaf Springs- Raised Heavy Duty (C)	\$ 589.21
3	TL-21	2	Rear Leaf Springs- Raised (B)	\$ 601.55
4	TL-27	2	Rear Leaf Springs- Raised Heavy Duty (C)	\$ 873.12
5	N71042	1	Front Urethane Kit- Spring Front/Rear eyes/Shackle	\$ 129.88
6	N71042	1	Rear Urethane Kit- Spring Front/Rear eyes/Shackle	\$ 129.88
7	UBL-08	4	Front U-Bolts	\$ 24.61
8	UBL-04	4	Rear U-Bolts	\$ 24.61
9	LGSK348	2	Front Greasable Shackle	\$ 53.93
10	LGPK351	2	Front Greasable Pin	\$ 40.13
11	LGSK352	2	Rear Greasable Shackle	\$ 53.93
12	LGPK354	2	Rear Greasable Pin	\$ 40.13
13	64612572	2	Front Gas Legend Shock Absorber	\$ 244.03
14	64612576	2	Rear Gas Legend Shock Absorber	\$ 244.03

SUSPENSION KITS

Kit Type	Part No.	Qty. per vehicle	Kit Description	List Price EACH
B	TOYKIT026-B	1	RAISED	\$ 3,940.33
C	TOYKIT026-C	1	RAISED HEAVY DUTY	\$ 4,733.61

ACCESSORIES (Not included in Kit)

Item	Part No.	Qty. per vehicle	Accessory Description	List Price EACH
1A	LGSKGASP-002L/H	1	Front P/Side- Anti Inversion Greasable Shackle	\$ 96.30
2A	LGSKGASP-002R/H	1	Front D/Side- Anti Inversion Greasable Shackle	\$ 96.30
3A	LGSKGASP-001L/H	1	Rear P/Side- Anti Inversion Greasable Shackle	\$ 77.04
4A	LGSKGASP-001R/H	1	Rear D/Side- Anti Inversion Greasable Shackle	\$ 77.04

STEERING DAMPERS (Not included in Kit)

Item	Part No.	Qty. per vehicle	Description	List Price EACH
1B	5450011	1	Steering Damper Assembly- Heavy Duty	\$ 143.75
2B	5450011-RTC	1	Steering Damper Assembly- Return to Centre	\$ 201.67

Part No.	Load Rating	Description
All spring load ratings are an approximate only. Vehicle ride heights will vary depending on load and accessories fitted.		
TL-19	0 to 100kg Constant Load	Suits Steel Bull Bar
TL-19MS	150 to 250kg Constant Load	Suits Steel Bull Bar, Winch, Underbody Protection etc.
TL-21	0 to 100kg Constant Load	
TL-27	150 to 250kg Constant Load	

TOYOTA- Landcruiser 75 Series
BJ, FJ, HJ75 Pick Up, Tray Back and Troop Carrier
11/84-12/89
Leaf/Leaf

KIT COMPONENTS

Item	Part No.	Qty. per vehicle	Description	List Price EACH
1	TL-19	2	Front Leaf Springs- Raised (B)	\$ 464.14
2	TL-19MS	2	Front Leaf Springs- Raised Heavy Duty (C)	\$ 589.21
3	TL-20	2	Rear Leaf Springs- Raised (B)	\$ 946.47
4	TL-20MS	2	Rear Leaf Springs- Raised Heavy Duty (C)	\$ 1,140.43
5	N71042	1	Front Urethane Kit- Spring Front/Rear eyes/Shackle	\$ 129.88
6	N71084	1	Rear Urethane Kit- Spring Front/Rear eyes/Shackle	\$ 176.93
7	UBL-08	4	Front U-Bolts	\$ 24.61
8	UBL-09	4	Rear U-Bolts	\$ 24.61
9	LGSK348	2	Front Greasable Shackle	\$ 53.93
10	LGPK351	2	Front Greasable Pin	\$ 40.13
11	LGSK353	2	Rear Greasable Shackle	\$ 53.93
12	LGPK354	2	Rear Greasable Pin	\$ 40.13
13	64612572	2	Front Gas Legend Shock Absorber	\$ 244.03
14	64612525	2	Rear Gas Legend Shock Absorber	\$ 269.66

SUSPENSION KITS

Kit Type	Part No.	Qty. per vehicle	Kit Description	List Price EACH
B	TOYKIT028-B	1	RAISED	\$ 4,728.49
C	TOYKIT028-C	1	RAISED HEAVY DUTY	\$ 5,366.53

ACCESSORIES (Not included in Kit)

Item	Part No.	Qty. per vehicle	Accessory Description	List Price EACH
1A	LGSKGASP-002L/H	1	Front P/Side- Anti Inversion Greasable Shackle	\$ 96.30
2A	LGSKGASP-002R/H	1	Front D/Side- Anti Inversion Greasable Shackle	\$ 96.30
3A	LGSKGASP-001L/H	1	Rear P/Side- Anti Inversion Greasable Shackle	\$ 77.04
4A	LGSKGASP-001R/H	1	Rear D/Side- Anti Inversion Greasable Shackle	\$ 77.04

TOYOTA- Landcruiser 75 Series
BJ, FJ, HJ75 Pick Up and Tray Back (Petrol and Diesel)
11/84-12/89
Leaf/Leaf

SPRAY RIG KIT

KIT COMPONENTS

Item	Part No.	Qty. per vehicle	Description	List Price EACH
1	TL-19MS	2	Front Leaf Springs- SPRAY RIG (S)	\$ 589.21
2	TL-20SR	2	Rear Leaf Springs- SPRAY RIG (S)	\$ 1,349.11
3	N71042	1	Front Urethane Kit- Spring Front/Rear eyes/Shackle	\$ 129.88
4	N71084	1	Rear Urethane Kit- Spring Front/Rear eyes/Shackle	\$ 176.93
5	UBL-08	4	Front U-Bolts	\$ 24.61
6	UBL-37	4	Rear U-Bolts	\$ 24.61
7	LGSK348	2	Front Greasable Shackle	\$ 53.93
8	LGPK351	2	Front Greasable Pin	\$ 40.13
9	LGSK353	2	Rear Greasable Shackle	\$ 53.93
10	LGPK354	2	Rear Greasable Pin	\$ 40.13
11	64612572	2	Front Gas Legend Shock Absorber	\$ 244.03
12	64612525	2	Rear Gas Legend Shock Absorber	\$ 269.66

SUSPENSION KITS

Kit Type	Part No.	Qty. per vehicle	Kit Description	List Price EACH
S	TOYKIT029-S	1	SPRAY RIG	\$ 5,783.90

Part No.	Load Rating	Description
All spring load ratings are an approximate only. Vehicle ride heights will vary depending on load and accessories fitted.		
TL-19	0 to 100kg Constant Load	Suits Steel Bull Bar
TL-19MS	150 to 250kg Constant Load	Suits Steel Bull Bar, Winch, Underbody Protection etc.
TL-20	0 to 100kg Constant Load	
TL-20MS	150 to 250kg Constant Load	
TL-20SR	250 to 350kg Constant Load	

TOYOTA- Landcruiser 75 Series
BJ, FJ, HJ75 Pick Up and Tray Back (Petrol and Diesel)
11/84-12/89
Leaf/Leaf

MINING VEHICLE KIT

KIT COMPONENTS

Item	Part No.	Qty. per vehicle	Description	List Price EACH
1	TL-19MS	2	Front Leaf Springs- MINING VEHICLE (M)	\$ 589.21
2	TL-20MS	2	Rear Leaf Springs- MINING VEHICLE (M)	\$ 1,140.43
3	N71042	1	Front Urethane Kit- Spring Front/Rear eyes/Shackle	\$ 129.88
4	N71084	1	Rear Urethane Kit- Spring Front/Rear eyes/Shackle	\$ 176.93
5	UBL-08	4	Front U-Bolts	\$ 24.61
6	UBL-37	4	Rear U-Bolts	\$ 24.61
7	LGSK348	2	Front Greasable Shackle	\$ 53.93
8	LGPK351	2	Front Greasable Pin	\$ 40.13
9	LGSK353	2	Rear Greasable Shackle	\$ 53.93
10	LGPK354	2	Rear Greasable Pin	\$ 40.13
11	64612572	2	Front Gas Legend Shock Absorber	\$ 244.03
12	64612525	2	Rear Gas Legend Shock Absorber	\$ 269.66

SUSPENSION KITS

Kit Type	Part No.	Qty. per vehicle	Kit Description	List Price EACH
M	TOYKIT030-M	1	MINING VEHICLE	\$ 5,366.53

TOYOTA- Landcruiser 75 Series
BJ, FJ, HJ75 Troop Carrier (Petrol and Diesel)
11/84-12/89
Leaf/Leaf

MINING VEHICLE KIT- Personnel Carrier

KIT COMPONENTS

Item	Part No.	Qty. per vehicle	Description	List Price EACH
1	TL-19MS	2	Front Leaf Springs- MINING VEHICLE (M)	\$ 589.21
2	TL-28MH	2	Rear Leaf Springs- MINING VEHICLE (M)	\$ 981.87
3	N71042	1	Front Urethane Kit- Spring Front/Rear eyes/Shackle	\$ 129.88
4	N71084	1	Rear Urethane Kit- Spring Front/Rear eyes/Shackle	\$ 176.93
5	UBL-08	4	Front U-Bolts	\$ 24.61
6	UBL-37	4	Rear U-Bolts	\$ 24.61
7	LGSK348	2	Front Greasable Shackle	\$ 53.93
8	LGPK351	2	Front Greasable Pin	\$ 40.13
9	LGSK353	2	Rear Greasable Shackle	\$ 53.93
10	LGPK354	2	Rear Greasable Pin	\$ 40.13
11	64612572	2	Front Gas Legend Shock Absorber	\$ 244.03
12	64612525	2	Rear Gas Legend Shock Absorber	\$ 269.66

SUSPENSION KITS

Kit Type	Part No.	Qty. per vehicle	Kit Description	List Price EACH
M	TOYKIT031-M	1	MINING VEHICLE	\$ 5,049.42

Part No.	Load Rating	Description
All spring load ratings are an approximate only. Vehicle ride heights will vary depending on load and accessories fitted.		
TL-19	0 to 100kg Constant Load	Suits Steel Bull Bar
TL-19MS	150 to 250kg Constant Load	Suits Steel Bull Bar, Winch, Underbody Protection etc.
TL-28MH	0 to 100kg Constant Load	
TL-20MS	150 to 250kg Constant Load	

TOYOTA- Landcruiser 75 Series
FZJ, HZJ75 Tray Back (Petrol and Diesel)
1/90-9/99
Leaf/Leaf

KIT COMPONENTS

Item	Part No.	Qty. per vehicle	Description	List Price EACH
1	TL-25	2	Front Leaf Springs- Raised (B)	\$ 651.74
2	TL-25MS	2	Front Leaf Springs- Raised Heavy Duty (C)	\$ 648.33
3	TL-26	2	Rear Leaf Springs- Raised (B)	\$ 1,071.39
4	TL-26MS	2	Rear Leaf Springs- Raised Heavy Duty (C)	\$ 1,204.96
5	N71042	1	Front Urethane Kit- Spring Front/Rear eyes/Shackle	\$ 129.88
6	N71084	1	Rear Urethane Kit- Spring Front/Rear eyes/Shackle	\$ 176.93
7	UBL-08	4	Front U-Bolts	\$ 24.61
8	UBL-09	4	Rear U-Bolts	\$ 24.61
9	LGSK356	2	Front Greasable Shackle	\$ 53.93
10	LGPK351	2	Front Greasable Pin	\$ 40.13
11	LGSK357	2	Rear Greasable Shackle	\$ 53.93
12	LGPK354	2	Rear Greasable Pin	\$ 40.13
13	64612572	2	Front Gas Legend Shock Absorber	\$ 244.03
14	64612492	2	Rear Gas Legend Shock Absorber	\$ 270.69

SUSPENSION KITS

Kit Type	Part No.	Qty. per vehicle	Kit Description	List Price EACH
B	TOYKIT032-B	1	RAISED	\$ 5,355.59
C	TOYKIT032-C	1	RAISED HEAVY DUTY	\$ 5,615.90

ACCESSORIES (Not included in Kit)

Item	Part No.	Qty. per vehicle	Accessory Description	List Price EACH
1A	LGSKGASP-002L/H	1	Front P/Side- Anti Inversion Greasable Shackle	\$ 96.30
2A	LGSKGASP-002R/H	1	Front D/Side- Anti Inversion Greasable Shackle	\$ 96.30
3A	LGSKGASP-001L/H	1	Rear P/Side- Anti Inversion Greasable Shackle	\$ 77.04
4A	LGSKGASP-001R/H	1	Rear D/Side- Anti Inversion Greasable Shackle	\$ 77.04

STEERING DAMPERS (Not included in Kit)

Item	Part No.	Qty. per vehicle	Description	List Price EACH
1B	5450011	1	Steering Damper Assembly- Heavy Duty	\$ 143.75
2B	5450011-RTC	1	Steering Damper Assembly- Return to Centre	\$ 201.67

Part No.	Load Rating	Description
All spring load ratings are an approximate only. Vehicle ride heights will vary depending on load and accessories fitted.		
TL-25	0 to 100kg Constant Load	Suits Steel Bull Bar
TL-25MS	150 to 250kg Constant Load	Suits Steel Bull Bar, Winch, Underbody Protection etc.
TL-26	0 to 100kg Constant Load	
TL-26MS	150 to 250kg Constant Load	

TOYOTA- Landcruiser 75 Series
FZJ, HZJ75 Tray Back (Petrol and Diesel)
1/90-9/99

Leaf/Leaf

SPRAY RIG KIT

KIT COMPONENTS

Item	Part No.	Qty. per vehicle	Description	List Price EACH
1	TL-25MS	2	Front Leaf Springs- SPRAY RIG (S)	\$ 648.33
2	TL-20SR	2	Rear Leaf Springs- SPRAY RIG (S)	\$ 1,349.11
3	N71042	1	Front Urethane Kit- Spring Front/Rear eyes/Shackle	\$ 129.88
4	N71084	1	Rear Urethane Kit- Spring Front/Rear eyes/Shackle	\$ 176.93
5	UBL-08	4	Front U-Bolts	\$ 24.61
6	UBL-37	4	Rear U-Bolts	\$ 24.61
7	LGSK356	2	Front Greasable Shackle	\$ 53.93
8	LGPK351	2	Front Greasable Pin	\$ 40.13
9	LGSK357	2	Rear Greasable Shackle	\$ 53.93
10	LGPK354	2	Rear Greasable Pin	\$ 40.13
11	64612572	2	Front Gas Legend Shock Absorber	\$ 244.03
12	64612492	2	Rear Gas Legend Shock Absorber	\$ 270.69

SUSPENSION KITS

Kit Type	Part No.	Qty. per vehicle	Kit Description	List Price EACH
S	TOYKIT034-S	1	SPRAY RIG	\$ 5,904.20

STEERING DAMPERS (Not included in Kit)

Item	Part No.	Qty. per vehicle	Description	List Price EACH
1B	5450011	1	Steering Damper Assembly- Heavy Duty	\$ 143.75
2B	5450011-RTC	1	Steering Damper Assembly- Return to Centre	\$ 201.67

TOYOTA- Landcruiser 75 Series
FZJ, HZJ75 Tray Back (Petrol and Diesel)
1/90-9/99

Leaf/Leaf

MINING VEHICLE KIT

KIT COMPONENTS

Item	Part No.	Qty. per vehicle	Description	List Price EACH
1	TL-25MS	2	Front Leaf Springs- MINING VEHICLE (M)	\$ 648.33
2	TL-26MS	2	Rear Leaf Springs- MINING VEHICLE (M)	\$ 1,204.96
3	N71042	1	Front Urethane Kit- Spring Front/Rear eyes/Shackle	\$ 129.88
4	N71084	1	Rear Urethane Kit- Spring Front/Rear eyes/Shackle	\$ 176.93
5	UBL-08	4	Front U-Bolts	\$ 24.61
6	UBL-37	4	Rear U-Bolts	\$ 24.61
7	LGSK356	2	Front Greasable Shackle	\$ 53.93
8	LGPK351	2	Front Greasable Pin	\$ 40.13
9	LGSK357	2	Rear Greasable Shackle	\$ 53.93
10	LGPK354	2	Rear Greasable Pin	\$ 40.13
11	64612572	2	Front Gas Legend Shock Absorber	\$ 244.03
12	64612492	2	Rear Gas Legend Shock Absorber	\$ 270.69

SUSPENSION KITS

Kit Type	Part No.	Qty. per vehicle	Kit Description	List Price EACH
M	TOYKIT035-M	1	MINING VEHICLE	\$ 5,615.90

STEERING DAMPERS (Not included in Kit)

Item	Part No.	Qty. per vehicle	Description	List Price EACH
1B	5450011	1	Steering Damper Assembly- Heavy Duty	\$ 143.75
2B	5450011-RTC	1	Steering Damper Assembly- Return to Centre	\$ 201.67

Part No.	Load Rating	Description
All spring load ratings are an approximate only. Vehicle ride heights will vary depending on load and accessories fitted.		
TL-25MS	0 to 100kg Constant Load	Suits Steel Bull Bar
TL-20SR	250 to 350kg Constant Load	
TL-26MS	150 to 250kg Constant Load	

TOYOTA- Landcruiser 75 Series
FZJ, HZJ75 Troop Carrier (Diesel)
1/90-9/99
Leaf/Leaf



MINING VEHICLE KIT- Personnel Carrier

KIT COMPONENTS

Item	Part No.	Qty. per vehicle	Description	List Price EACH
1	TL-25	2	Front Leaf Springs- MINING VEHICLE (M)	\$ 651.74
2	TL-26MS	2	Rear Leaf Springs- MINING VEHICLE (M)	\$ 1,204.96
3	N71042	1	Front Urethane Kit- Spring Front/Rear eyes/Shackle	\$ 129.88
4	N71084	1	Rear Urethane Kit- Spring Front/Rear eyes/Shackle	\$ 176.93
5	UBL-08	4	Front U-Bolts	\$ 24.61
6	UBL-09	4	Rear U-Bolts	\$ 24.61
7	LGSK356	2	Front Greasable Shackle	\$ 53.93
8	LGPK351	2	Front Greasable Pin	\$ 40.13
9	LGSK357	2	Rear Greasable Shackle	\$ 53.93
10	LGPK354	2	Rear Greasable Pin	\$ 40.13
11	64612572	2	Front Gas Legend Shock Absorber	\$ 244.03
12	64612492	2	Rear Gas Legend Shock Absorber	\$ 270.69

SUSPENSION KITS

Kit Type	Part No.	Qty. per vehicle	Kit Description	List Price EACH
M	TOYKIT036-M	1	MINING VEHICLE	\$ 5,622.72

STEERING DAMPERS (Not included in Kit)

Item	Part No.	Qty. per vehicle	Description	List Price EACH
1B	5450011	1	Steering Damper Assembly- Heavy Duty	\$ 143.75
2B	5450011-RTC	1	Steering Damper Assembly- Return to Centre	\$ 201.67

Part No.	Load Rating	Description
All spring load ratings are an approximate only. Vehicle ride heights will vary depending on load and accessories fitted.		
TL-25	0 to 100kg Constant Load	Suits Steel Bull Bar
TL-26MS	150 to 250kg Constant Load	

TOYOTA- Landcruiser 78/79 Series
FZJ, HZJ79 Tray Back (Petrol and Diesel)
10/99-2/07
Coil/Leaf



KIT COMPONENTS

Item	Part No.	Qty. per vehicle	Description	List Price EACH
1	TFS-79	2	Front Coil Springs- Raised (B)	\$ 126.26
2	TFR-79	2	Front Coil Springs- Raised Heavy Duty (C)	\$ 150.59
3	TL-79	2	Rear Leaf Springs- Raised (B)	\$ 1,142.84
4	TL-79MS	2	Rear Leaf Springs- Raised Heavy Duty (C)	\$ 1,279.98
5	N72336	1	Rear Urethane Kit- Spring Front Eyes (Non Shell bush)	\$ 59.57
This P/N only suits Lovells Greasable Shackles/Pins. Does not fit Original Equipment parts.				
6	N72336	1	Rear Urethane Kit- Spring Rear Eyes (Non Shell bush)	\$ 59.57
This P/N only suits Lovells Greasable Shackles/Pins. Does not fit Original Equipment parts.				
7	N72337	1	Rear Urethane Kit- Spring Shackle	\$ 58.54
This P/N only suits Lovells Greasable Shackles/Pins. Does not fit Original Equipment parts.				
8	UBL-37	4	Rear U-Bolts	\$ 24.61
9	LGSK388	2	Rear Greasable Shackle Kit	\$ 96.30
10	LGPK388	2	Rear Greasable Pin Kit	\$ 47.08
11	64612491	2	Front Gas Legend Shock Absorber	\$ 272.97
12	64612492	2	Rear Gas Legend Shock Absorber	\$ 270.69
Note: Extra Long Travel Front Gas Legend Shock Absorber option available P/N 64612541 (\$244.02 each)				
Suits C Kit as alternative P/N or Hi Lift Applications where lift exceeds 75mm-100mm (3" - 4")				
Note: Extra Long Travel Rear Gas Legend Shock Absorber option available P/N 64612848 (\$273.00 each)				
Suits C Kit as alternative P/N or Hi Lift Applications where lift exceeds 75mm-100mm (3" - 4")				

SUSPENSION KITS

Kit Type	Part No.	Qty. per vehicle	Kit Description	List Price EACH
B	TOYKIT037-B	1		\$ 4,188.39
C	TOYKIT037-C	1	RAISED HEAVY DUTY	\$ 4,511.33

ACCESSORIES (Not included in Kit)

Item	Part No.	Qty. per vehicle	Accessory Description	List Price EACH
1A	N81730	1	Front Urethane Bush Kit- Adjust. Caster Bush	\$ 297.55
2A	N72336-NG	1	Rear Urethane Kit- Spring Front Eyes (SUITS OE Pin)	\$ 250.44
3A	N72336-NG	1	Rear Urethane Kit- Spring Rear Eyes (SUITS OE Shackle)	\$ 250.44
4A	N72337-NG	1	Rear Urethane Kit- Spring Shackle (SUITS OE Shackle)	\$ 126.88
5A	GVM79-Spacer	1	Brake Proportioning Link Spacer	\$ 57.22
6A	HCEB001	1	Rear Handbrake Cable Extension Bracket	\$ 72.39

Highlighted Accessories: Lovells strongly recommend fitting these Part Numbers for all applications.

STEERING DAMPERS (Not included in Kit)

Item	Part No.	Qty. per vehicle	Description	List Price EACH
1B	5450011	1	Steering Damper Assembly- Heavy Duty	\$ 143.75
2B	5450011-RTC	1	Steering Damper Assembly- Return to Centre	\$ 201.67

Part No.	Load Rating	Description
All spring load ratings are an approximate only. Vehicle ride heights will vary depending on load and accessories fitted.		
TFS-79	0 to 100kg Constant Load	Suits Steel Bull Bar
TFR-79	100 to 150kg Constant Load	Suits Steel Bull Bar, Winch, Underbody Protection etc.
TL-79	0 to 100kg Constant Load	
TL-79MS	150 to 250kg Constant Load	

TOYOTA- Landcruiser 78/79 Series
FZJ, HZJ78 Troop Carrier (Petrol and Diesel)
10/99-2/07
Coil/Leaf

KIT COMPONENTS

Item	Part No.	Qty. per vehicle	Description	List Price EACH
1	TFS-79	2	Front Coil Springs- Raised (B)	\$ 126.26
2	TFR-79	2	Front Coil Springs- Raised Heavy Duty (C)	\$ 150.59
3	TL-79MS	2	Rear Leaf Springs- Raised (B)	\$ 1,279.98
4	TL-79XHD	2	Rear Leaf Springs- Raised Heavy Duty (C)	\$ 1,417.12
5	N72336	1	Rear Urethane Kit- Spring Front Eyes (Non Shell bush)	\$ 59.57
This P/N only suits Lovells Greasable Shackles/Pins. Does not fit Original Equipment parts.				
6	N72336	1	Rear Urethane Kit- Spring Rear Eyes (Non Shell bush)	\$ 59.57
This P/N only suits Lovells Greasable Shackles/Pins. Does not fit Original Equipment parts.				
7	N72337	1	Rear Urethane Kit- Spring Shackle	\$ 58.54
This P/N only suits Lovells Greasable Shackles/Pins. Does not fit Original Equipment parts.				
8	UBL-37	4	Rear U-Bolts	\$ 24.61
9	LGSK388	2	Rear Greasable Shackle Kit	\$ 96.30
10	LGPK388	2	Rear Greasable Pin Kit	\$ 47.08
11	64612491	2	Front Gas Legend Shock Absorber	\$ 272.97
12	64612492	2	Rear Gas Legend Shock Absorber	\$ 270.69
Note: Extra Long Travel Front Gas Legend Shock Absorber option available P/N 64612541 (\$244.02 each)				
Suits C Kit as alternative P/N or Hi Lift Applications where lift exceeds 75mm-100mm (3" - 4")				
Note: Extra Long Travel Rear Gas Legend Shock Absorber option available P/N 64612848 (\$273.30 each)				
Suits C Kit as alternative P/N or Hi Lift Applications where lift exceeds 75mm-100mm (3" - 4")				

SUSPENSION KITS

Kit Type	Part No.	Qty. per vehicle	Kit Description	List Price EACH
B	TOYKIT038-B	1	RAISED	\$ 4,462.67
C	TOYKIT038-C	1	RAISED HEAVY DUTY	\$ 4,785.61

ACCESSORIES (Not included in Kit)

Item	Part No.	Qty. per vehicle	Accessory Description	List Price EACH
1A	N81730	1	Front Urethane Bush Kit- Adjust. Caster Bush	\$ 297.55
2A	N72336-NG	1	Rear Urethane Kit- Spring Front Eyes (SUITS OE Pin)	\$ 250.44
3A	N73098-NG	1	Rear Urethane Kit- Spring Rear Eyes (SUITS OE Shackle)	\$ 250.44
4A	N72337-NG	1	Rear Urethane Kit- Spring Shackle (SUITS OE Shackle)	\$ 126.88
5A	GVM79-Spacer	1	Brake Proportioning Link Spacer	\$ 57.22
6A	HCEB001	1	Rear Handbrake Cable Extension Bracket	\$ 72.39

Highlighted Accessories: Lovells strongly recommend fitting these Part Numbers for all applications.

STEERING DAMPERS (Not included in Kit)

Item	Part No.	Qty. per vehicle	Description	List Price EACH
1B	5450011	1	Steering Damper Assembly- Heavy Duty	\$ 143.75
2B	5450011-RTC	1	Steering Damper Assembly- Return to Centre	\$ 201.67

Part No.	Load Rating	Description
All spring load ratings are an approximate only. Vehicle ride heights will vary depending on load and accessories fitted.		
TFS-79	0 to 100kg Constant Load	Suits Steel Bull Bar
TFR-79	100 to 150kg Constant Load	Suits Steel Bull Bar, Winch, Underbody Protection etc.
TL-79MS	150 to 250kg Constant Load	
TL-79XHD	400 to 500kg Constant Load	

TOYOTA- Landcruiser 78/79 Series
FZJ, HZJ79 Tray Back (Petrol and Diesel)
10/99-2/07
Coil/Leaf



SPRAY RIG KIT

KIT COMPONENTS

Item	Part No.	Qty. per vehicle	Description	List Price EACH
1	TFR-79	2	Front Coil Springs- SPRAY RIG (S)	\$ 150.59
2	TL-79SR	2	Rear Leaf Springs- SPRAY RIG (S)	\$ 1,554.26
3	N81730	1	Front Urethane Bush Kit- Adjust. Caster Bush	\$ 297.55
4	N72336	1	Rear Urethane Kit- Spring Front Eyes (Non Shell bush)	\$ 59.57
	This P/N only suits Lovells Greasable Shackles/Pins. Does not fit Original Equipment parts.			
5	N72336	1	Rear Urethane Kit- Spring Rear Eyes (Non Shell bush)	\$ 59.57
	This P/N only suits Lovells Greasable Shackles/Pins. Does not fit Original Equipment parts.			
6	N72337	1	Rear Urethane Kit- Spring Shackle	\$ 58.54
	This P/N only suits Lovells Greasable Shackles/Pins. Does not fit Original Equipment parts.			
7	UBL-37	4	Rear U-Bolts	\$ 24.61
8	LGSK388	2	Rear Greasable Shackle Kit	\$ 96.30
9	LGPk388	2	Rear Greasable Pin Kit	\$ 47.08
10	64612491	2	Front Gas Legend Shock Absorber	\$ 272.97
11	64612492	2	Rear Gas Legend Shock Absorber	\$ 270.69
12	GVM79-Spacer	1	Brake Proportioning Link Spacer	\$ 57.22
13	HCEB001	1	Rear Handbrake Cable Extension Bracket	\$ 72.39
Note: Extra Long Travel Front Gas Legend Shock Absorber option available P/N 64612541 (\$244.02 each) Suits C Kit as alternative P/N or Hi Lift Applications where lift exceeds 75mm-100mm (3" - 4")				
Note: Extra Long Travel Rear Gas Legend Shock Absorber option available P/N 64612848 (\$273.30 each) Suits C Kit as alternative P/N or Hi Lift Applications where lift exceeds 75mm-100mm (3" - 4")				

SUSPENSION KITS

Kit Type	Part No.	Qty. per vehicle	Kit Description	List Price EACH
S	TOYKIT039-S	1	SPRAY RIG	\$ 5,487.06

Note: Above spring Part Numbers suit alloy tray fitment only. For steel tray Part Numbers please contact Lovells Springs.

STEERING DAMPERS (Not included in Kit)

Item	Part No.	Qty. per vehicle	Description	List Price EACH
1B	5450011	1	Steering Damper Assembly- Heavy Duty	\$ 143.75
2B	5450011-RTC	1	Steering Damper Assembly- Return to Centre	\$ 201.67

Part No.	Load Rating	Description
All spring load ratings are an approximate only. Vehicle ride heights will vary depending on load and accessories fitted.		
TFR-79	100 to 150kg Constant Load	Suits Steel Bull Bar, Winch, Underbody Protection etc.
TL-79SR	500 to 600kg Constant Load	

TOYOTA- Landcruiser 78/79 Series
FZJ, HZJ79 Tray Back (Petrol and Diesel)
10/99-2/07
Coil/Leaf



MINING VEHICLE KIT

KIT COMPONENTS

Item	Part No.	Qty. per vehicle	Description	List Price EACH
1	TFR-79	2	Front Coil Springs- MINING VEHICLE (M)	\$ 150.59
2	TL-79XHD	2	Rear Leaf Springs- MINING VEHICLE (M)	\$ 1,417.12
3	N81730	1	Front Urethane Bush Kit- Adjust. Caster Bush	\$ 297.55
4	N72336	1	Rear Urethane Kit- Spring Front Eyes (Non Shell bush)	\$ 59.57
	This P/N only suits Lovells Greasable Shackles/Pins. Does not fit Original Equipment parts.			
5	N72336	1	Rear Urethane Kit- Spring Rear Eyes (Non Shell bush)	\$ 59.57
	This P/N only suits Lovells Greasable Shackles/Pins. Does not fit Original Equipment parts.			
6	N72337	1	Rear Urethane Kit- Spring Shackle	\$ 58.54
	This P/N only suits Lovells Greasable Shackles/Pins. Does not fit Original Equipment parts.			
7	UBL-37	4	Rear U-Bolts	\$ 24.61
8	LGSK388	2	Rear Greasable Shackle Kit	\$ 96.30
9	LGPK388	2	Rear Greasable Pin Kit	\$ 47.08
10	64612491	2	Front Gas Legend Shock Absorber	\$ 272.97
11	64612492	2	Rear Gas Legend Shock Absorber	\$ 270.69
12	GVM79-Spacer	1	Brake Proportioning Link Spacer	\$ 57.22
13	HCEB001	1	Rear Handbrake Cable Extension Bracket	\$ 72.39
Note: Extra Long Travel Front Gas Legend Shock Absorber option available P/N 64612541 (\$244.02 each) Suits C Kit as alternative P/N or Hi Lift Applications where lift exceeds 75mm-100mm (3" - 4") Note: Extra Long Travel Rear Gas Legend Shock Absorber option available P/N 64612848 (\$273.30 each) Suits C Kit as alternative P/N or Hi Lift Applications where lift exceeds 75mm-100mm (3" - 4")				

SUSPENSION KITS

Kit Type	Part No.	Qty. per vehicle	Kit Description	List Price EACH
M	TOYKIT040-M	1	MINING VEHICLE	\$ 5,212.77

Note: Above spring Part Numbers suit alloy tray fitment only. For steel tray Part Numbers please contact Lovells Springs.

STEERING DAMPERS (Not included in Kit)

Item	Part No.	Qty. per vehicle	Description	List Price EACH
1B	5450011	1	Steering Damper Assembly- Heavy Duty	\$ 143.75
2B	5450011-RTC	1	Steering Damper Assembly- Return to Centre	\$ 201.67

Part No.	Load Rating	Description
All spring load ratings are an approximate only. Vehicle ride heights will vary depending on load and accessories fitted.		
TFR-79	100 to 150kg Constant Load	Suits Steel Bull Bar, Winch, Underbody Protection etc.
TL-79XHD	400 to 500kg Constant Load	

TOYOTA- Landcruiser 78/79 Series
FZJ, HZJ78 Troop Carrier (Petrol and Diesel)
10/99-2/07
Coil/Leaf

	MINING VEHICLE KIT- Personnel Carrier	
--	--	--

KIT COMPONENTS

Item	Part No.	Qty. per vehicle	Description	List Price EACH
1	TFR-79	2	Front Coil Springs- MINING VEHICLE (M)	\$ 150.59
2	TL-79XHD	2	Rear Leaf Springs- MINING VEHICLE (M)	\$ 1,417.12
3	N81730	1	Front Urethane Bush Kit- Adjust. Caster Bush	\$ 297.55
4	N72336	1	Rear Urethane Kit- Spring Front Eyes (Non Shell bush)	\$ 59.57
This P/N only suits Lovells Greasable Shackles/Pins. Does not fit Original Equipment parts.				
5	N72336	1	Rear Urethane Kit- Spring Rear Eyes (Non Shell bush)	\$ 59.57
This P/N only suits Lovells Greasable Shackles/Pins. Does not fit Original Equipment parts.				
6	N72337	1	Rear Urethane Kit- Spring Shackle	\$ 58.54
This P/N only suits Lovells Greasable Shackles/Pins. Does not fit Original Equipment parts.				
7	UBL-37	4	Rear U-Bolts	\$ 24.61
8	LGSK388	2	Rear Greasable Shackle Kit	\$ 96.30
9	LGPK388	2	Rear Greasable Pin Kit	\$ 47.08
10	64612491	2	Front Gas Legend Shock Absorber	\$ 272.97
11	64612492	2	Rear Gas Legend Shock Absorber	\$ 270.69
12	GVM79-Spacer	1	Brake Proportioning Link Spacer	\$ 57.22
13	HCEB001	1	Rear Handbrake Cable Extension Bracket	\$ 72.39
Note: Extra Long Travel Front Gas Legend Shock Absorber option available P/N 64612541 (\$244.02 each) Suits C Kit as alternative P/N or Hi Lift Applications where lift exceeds 75mm-100mm (3" - 4") Note: Extra Long Travel Rear Gas Legend Shock Absorber option available P/N 64612848 (\$273.30 each) Suits C Kit as alternative P/N or Hi Lift Applications where lift exceeds 75mm-100mm (3" - 4")				

SUSPENSION KITS

Kit Type	Part No.	Qty. per vehicle	Kit Description	List Price EACH
M	TOYKIT041-M	1	MINING VEHICLE	\$ 5,212.77

STEERING DAMPERS (Not included in Kit)

Item	Part No.	Qty. per vehicle	Description	List Price EACH
1B	5450011	1	Steering Damper Assembly- Heavy Duty	\$ 143.75
2B	5450011-RTC	1	Steering Damper Assembly- Return to Centre	\$ 201.67

Part No.	Load Rating	Description
All spring load ratings are an approximate only. Vehicle ride heights will vary depending on load and accessories fitted.		
TFR-79	100 to 150kg Constant Load	Suits Steel Bull Bar, Winch, Underbody Protection etc.
TL-79XHD	400 to 500kg Constant Load	

TOYOTA- Landcruiser 78/79 Series
FZJ, HZJ79 Tray Back (Petrol and Diesel)
10/99-2/07
Coil/Leaf



3700KG GVM Upgrade Kit (Fitted Price)- State Compliance

KIT COMPONENTS

Item	Part No.	Qty. per vehicle	Description	SOLD AS KIT ONLY
1	TFS-79	2	Front Coil Springs- GVM UPGRADE (GVM)	
2	TL-79XHD	2	Rear Leaf Springs- GVM UPGRADE (GVM)	
3	N81730	1	Front Urethane Bush Kit- Adjust. Caster Bush	
4	N72336	1	Rear Urethane Kit- Spring Front Eyes (Non Shell bush)	
5	N72336	1	Rear Urethane Kit- Spring Rear Eyes (Non Shell bush)	
6	N72337	1	Rear Urethane Kit- Spring Shackle	
7	UBL-37	4	Rear U-Bolts	
8	LGSK388	2	Rear Greasable Shackle Kit	
9	LGPK388	2	Rear Greasable Pin Kit	
10	64612491	2	Front Gas Legend Shock Absorber	
11	64612492	2	Rear Gas Legend Shock Absorber	
12	GVM79-Spacer	1	Brake Proportioning Link Spacer	
13	HCEB001	1	Rear Handbrake Cable Extension Bracket	
14	77ACMB-LCRUISER70-GVM-IND	2	Category 6 Indicators ADR 13/00	
15		1	Proportioning Valve Adjustment Warning Decal	
16		1	3700kg Tyre Loading Placard (Decal)	
17		1	GVM Upgrade Fitting Instructions	

SUSPENSION KITS

Kit Type	Part No.	Qty. per vehicle	Kit Description	Retail Price
GVM	TOYKIT042-GVM-ST	1	GVM Upgrade Kit (Fitted Price)	\$ 5,109.00

NOTE: Fitted Price plus GST

Part No.	Load Rating	Description
All spring load ratings are an approximate only. Vehicle ride heights will vary depending on load and accessories fitted.		
TFR-79	100 to 150kg Constant Load	Suits Steel Bull Bar, Winch, Underbody Protection etc.
TL-79XHD	400 to 500kg Constant Load	To GVM

***NOTE: The above GVM Upgrade Kit for Federal Compliance under Second Stage Manufacturer Approval, with a Federal compliance plate, is no longer available
 The above kit can still be supplied under State Compliance and will require inspection, by a Lovells endorsed signatory and /or Production Facility.
 Consult your nearest Lovells Production facility for Individual State requirements.

TOYOTA- Landcruiser 78/79 Series
FZJ, HZJ78 Troop Carrier (Petrol and Diesel)
10/99-2/07
Coil/Leaf

3700KG GVM Upgrade Kit (Fitted Price)- State Compliance

KIT COMPONENTS

Item	Part No.	Qty. per vehicle	Description	SOLD AS KIT ONLY
1	TFS-79	2	Front Coil Springs- GVM UPGRADE (GVM)	
2	TL-79XHD	2	Rear Leaf Springs- GVM UPGRADE (GVM)	
3	N81730	1	Front Urethane Bush Kit- Adjust. Caster Bush	
4	N72336	1	Rear Urethane Kit- Spring Front Eyes (Non Shell bush)	
5	N72336	1	Rear Urethane Kit- Spring Rear Eyes (Non Shell bush)	
6	N72337	1	Rear Urethane Kit- Spring Shackle	
7	UBL-37	4	Rear U-Bolts	
8	LGSK388	2	Rear Greasable Shackle Kit	
9	LGPK388	2	Rear Greasable Pin Kit	
10	64612491	2	Front Gas Legend Shock Absorber	
11	64612492	2	Rear Gas Legend Shock Absorber	
12	GVM79-Spacer	1	Brake Proportioning Link Spacer	
13	HCEB001	1	Rear Handbrake Cable Extension Bracket	
14	77ACMB-LCRUISER70-GVM-IND	2	Category 6 Indicators ADR 13/00	
15		1	Proportioning Valve Adjustment Warning Decal	
16		1	3700kg Tyre Loading Placard (Decal)	
17		1	GVM Upgrade Fitting Instructions	

SUSPENSION KITS

Kit Type	Part No.	Qty. per vehicle	Kit Description	Retail Price
GVM	TOYKIT042-GVM-ST	1	GVM Upgrade Kit (Fitted Price)	\$ 5,109.00

NOTE: Fitted Price plus GST

Part No.	Load Rating	Description
All spring load ratings are an approximate only. Vehicle ride heights will vary depending on load and accessories fitted.		
TFR-79	100 to 150kg Constant Load	Suits Steel Bull Bar, Winch, Underbody Protection etc.
TL-79XHD	400 to 500kg Constant Load	To GVM

***NOTE: The above GVM Upgrade Kit for Federal Compliance under Second Stage Manufacturer Approval, with a Federal compliance plate, is no longer available
 The above kit can still be supplied under State Compliance and will require inspection, by a Lovells endorsed signatory and /or Production Facility.
 Consult your nearest Lovells Production facility for Individual State requirements.

TOYOTA- Landcruiser 78 Series
HZJ78 Troop Carrier (Diesel)
9/22 On
Coil/Leaf

	4200KG GVM Upgrade Kit (Fitted Price)
--	--

KIT COMPONENTS

Item	Part No.	Qty. per vehicle	Description	SOLD AS KIT ONLY
1	TFS-79	2	Front Coil Springs- GVM UPGRADE (GVM)	
2	TL-79XHD	2	Rear Leaf Springs- GVM UPGRADE (GVM)	
3	N81730	1	Front Urethane Bush Kit- Adjust. Caster Bush	
4	N72336	2	Rear Urethane Kit- Spring Front Eyes (Non Shell bush)	
5	N72337	1	Rear Urethane Kit- Spring Shackle	
6	UBL-37	4	Rear U-Bolts	
7	LGSK388	2	Rear Greasable Shackle Kit	
8	HCEB001	1	Rear Handbrake Cable Extension Bracket	
9	LGPK388	2	Rear Greasable Pin Kit	
10	64612491	2	Front Gas Legend Shock Absorber	
11	64612492	2	Rear Gas Legend Shock Absorber	
	or			
12	64612491-2.0ADJMONO	2	Front 20mm Tube Shock With Remote Reservoir (Platinum Only)	
13	64612492SL-2.0ADJMONO	1	Rear 20mm Tube Shock With Remote Reservoir (Platinum Only)	
14	64612492SR-2.0ADJMONO	1	Rear 20mm Tube Shock With Remote Reservoir (Platinum Only)	
15		1	4200kg Compliance Plate	
16		1	Proportioning Valve Adjustment Warning Decal	
17		1	4200kg Tyre Loading Placard (Decal)	
18		1	GVM Upgrade Fitting Instructions	

SUSPENSION KITS

Kit Type	Part No.	Qty. per vehicle	Kit Description	Retail Price
GVM	TOYKIT080-GVM-J7	1	GVM Upgrade Kit (Fitted Price)	\$ 4,809.00
	TOYKIT080-GVM-PLAT-J7		GVM Upgrade Kit (Fitted Price)	\$ 5,909.00

Part No.	Load Rating	Description
All spring load ratings are an approximate only. Vehicle ride heights will vary depending on load and accessories fitted.		
TFS-79	100 to 150kg Constant Load	Suits Steel Bull Bar, Winch, Underbody Protection etc.
TL-79XHD	400 to 500kg Constant Load	To GVM

*The solution for owners/managers of Toyota Landcruiser 70 Series Troop carrier vehicles who have a need to carry loads to a GVM of 4200kg (up from 3510kg standard GVM), while at the same time meeting the practical and documentary compliance requirements of Work Safety, Police Licensing, Insurance, Lessors and Fleet Managers. This kit is complied by Department of Infrastructure, Transport, Regional Development and Local Government and comes complete with a Second Stage Manufacturer compliance plate. (Australian Compliance ONLY). Federal Compliance GVM Upgrades can only be fitted to vehicles prior to registration. **Lovells Compliance Plate Approval Number (VTA) 061197***

Note: Above price is net and no discounts apply. Lovells Authorised Fitters (holding Production Facility ID) are entitled to a Fitters Price. (Available upon application)

Above price includes fitting by a Lovells Authorised Fitter and does not include GST

*****NOTE: The above GVM Upgrade can be supplied under State Compliance (for already registered vehicles) and the vehicle individually engineered for the State of registration. Includes State engineering certificate or certification plate. Kit part numbers, order forms, details and pricing are available upon application**

TOYOTA- Landcruiser 70 Series

LC79 Tray Back (V8 Diesel)- Single Cab and Dual Cab

3/07 on

Coil/Leaf

KIT COMPONENTS

Item	Part No.	Qty. per vehicle	Description	List Price EACH
1	TFS-79	2	Front Coil Springs- Raised (B)	\$ 126.26
2	TFR-79	2	Front Coil Springs- Raised Heavy Duty (C)	\$ 150.59
3	TL-79	2	Rear Leaf Springs- Raised (B)	\$ 1,142.84
4	TL-79MS	2	Rear Leaf Springs- Raised Heavy Duty (C)	\$ 1,279.98
5	N72336	1	Rear Urethane Kit- Spring Front Eyes (Non Shell bush)	\$ 59.57
	This P/N only suits Lovells Greasable Shackles/Pins. Does not fit Original Equipment parts.			
6	N72336	1	Rear Urethane Kit- Spring Rear Eyes (Non Shell bush)	\$ 59.57
	This P/N only suits Lovells Greasable Shackles/Pins. Does not fit Original Equipment parts.			
7	N72337	1	Rear Urethane Kit- Spring Shackle	\$ 58.54
	This P/N only suits Lovells Greasable Shackles/Pins. Does not fit Original Equipment parts.			
8	UBL-37	4	Rear U-Bolts	\$ 24.61
9	LGSK388	2	Rear Greasable Shackle Kit	\$ 96.30
10	LGPK388	2	Rear Greasable Pin Kit	\$ 47.08
11	64612491	2	Front Gas Legend Shock Absorber	\$ 272.97
12	64612492	2	Rear Gas Legend Shock Absorber	\$ 270.69

Note: Extra Long Travel Front Gas Legend Shock Absorber option available P/N 64612541 (\$244.02 each)

Suits C Kit as alternative P/N or Hi Lift Applications where lift exceeds 75mm-100mm (3" - 4")

Note: Extra Long Travel Rear Gas Legend Shock Absorber option available P/N 64612848 (\$273.30 each)

Suits C Kit as alternative P/N or Hi Lift Applications where lift exceeds 75mm-100mm (3" - 4")

SUSPENSION KITS

Kit Type	Part No.	Qty. per vehicle	Kit Description	List Price EACH
B	TOYKIT055-B	1	RAISED	\$ 4,188.39
C	TOYKIT055-C	1	RAISED HEAVY DUTY	\$ 4,511.33

ACCESSORIES (Not included in Kit)

Item	Part No.	Qty. per vehicle	Accessory Description	List Price EACH
1A	N81730	1	Front Urethane Bush Kit- Adjust. Caster Bush	\$ 297.55
2A	N72336-NG	1	Rear Urethane Kit- Spring Front Eyes (SUITS OE Pin)	\$ 250.44
3A	N72336-NG	1	Rear Urethane Kit- Spring Rear Eyes (SUITS OE Shackle)	\$ 250.44
4A	N72337-NG	1	Rear Urethane Kit- Spring Shackle (SUITS OE Shackle)	\$ 126.88
5A	GVM79-Spacer	1	Brake Proportioning Link Spacer	\$ 57.22
6A	HCEB001	1	Rear Handbrake Cable Extension Bracket	\$ 72.39
7A	CH003	1	Rear Brake Line Extension Plate	\$ 29.41

Highlighted Accessories: Lovells strongly recommend fitting these Part Numbers for all applications.

STEERING DAMPERS (Not included in Kit)

Item	Part No.	Qty. per vehicle	Description	List Price EACH
1B	5450012	1	Steering Damper Assembly- Heavy Duty	\$ 172.53
2B	5450012-RTC	1	Steering Damper Assembly- Return to Centre	\$ 189.75

Part No.	Load Rating	Description
All spring load ratings are an approximate only. Vehicle ride heights will vary depending on load and accessories fitted.		
TFS-79	0 to 100kg Constant Load	Suits Steel Bull Bar
TFR-79	100 to 150kg Constant Load	Suits Steel Bull Bar, Winch, Underbody Protection etc.
TL-79	0 to 100kg Constant Load	
TL-79MS	150 to 250kg Constant Load	

TOYOTA- Landcruiser 70 Series
LC78 Troop Carrier (V8 Diesel)
3/07 on
Coil/Leaf



KIT COMPONENTS

Item	Part No.	Qty. per vehicle	Description	List Price EACH
1	TFS-79	2	Front Coil Springs- Raised (B)	\$ 126.26
2	TFR-79	2	Front Coil Springs- Raised Heavy Duty (C)	\$ 150.59
3	TL-79MS	2	Rear Leaf Springs- Raised (B)	\$ 1,279.98
4	TL-79XHD	2	Rear Leaf Springs- Raised Heavy Duty (C)	\$ 1,417.12
5	N72336	1	Rear Urethane Kit- Spring Front Eyes (Non Shell bush)	\$ 59.57
This P/N only suits Lovells Greasable Shackles/Pins. Does not fit Original Equipment parts.				
6	N72336	1	Rear Urethane Kit- Spring Rear Eyes (Non Shell bush)	\$ 59.57
This P/N only suits Lovells Greasable Shackles/Pins. Does not fit Original Equipment parts.				
7	N72337	1	Rear Urethane Kit- Spring Shackle	\$ 58.54
This P/N only suits Lovells Greasable Shackles/Pins. Does not fit Original Equipment parts.				
8	UBL-37	4	Rear U-Bolts	\$ 24.61
9	LGSK388	2	Rear Greasable Shackle Kit	\$ 96.30
10	LGPK388	2	Rear Greasable Pin Kit	\$ 47.08
11	64612491	2	Front Gas Legend Shock Absorber	\$ 272.97
12	64612492	2	Rear Gas Legend Shock Absorber	\$ 270.69
Note: Extra Long Travel Front Gas Legend Shock Absorber option available P/N 64612541 (\$244.02 each)				
Suits C Kit as alternative P/N or Hi Lift Applications where lift exceeds 75mm-100mm (3" - 4")				
Note: Extra Long Travel Rear Gas Legend Shock Absorber option available P/N 64612848 (\$273.30 each)				
Suits C Kit as alternative P/N or Hi Lift Applications where lift exceeds 75mm-100mm (3" - 4")				

SUSPENSION KITS

Kit Type	Part No.	Qty. per vehicle	Kit Description	List Price EACH
B	TOYKIT056-B	1	RAISED	\$ 4,462.67
C	TOYKIT056-C	1	RAISED HEAVY DUTY	\$ 4,785.61

ACCESSORIES (Not included in Kit)

Item	Part No.	Qty. per vehicle	Accessory Description	List Price EACH
1A	N81730	1	Front Urethane Bush Kit- Adjust. Caster Bush	\$ 297.55
2A	N72336-NG	1	Rear Urethane Kit- Spring Front Eyes (SUITS OE Pin)	\$ 250.44
3A	N72336-NG	1	Rear Urethane Kit- Spring Rear Eyes (SUITS OE Shackle)	\$ 250.44
4A	N72337-NG	1	Rear Urethane Kit- Spring Shackle (SUITS OE Shackle)	\$ 126.88
5A	GVM79-Spacer	1	Brake Proportioning Link Spacer	\$ 57.22
6A	HCEB001	1	Rear Handbrake Cable Extension Bracket	\$ 72.39

Highlighted Accessories: Lovells strongly recommend fitting these Part Numbers for all applications.

STEERING DAMPERS (Not included in Kit)

Item	Part No.	Qty. per vehicle	Description	List Price EACH
1B	5450012	1	Steering Damper Assembly- Heavy Duty	\$ 172.53
2B	5450012-RTC	1	Steering Damper Assembly- Return to Centre	\$ 189.75

Part No.	Load Rating	Description
All spring load ratings are an approximate only. Vehicle ride heights will vary depending on load and accessories fitted.		
TFS-79	0 to 100kg Constant Load	Suits Steel Bull Bar
TFR-79	100 to 150kg Constant Load	Suits Steel Bull Bar, Winch, Underbody Protection etc.
TL-79MS	150 to 250kg Constant Load	
TL-79XHD	400 to 500kg Constant Load	

TOYOTA- Landcruiser 70 Series
LC76 Wagon- 4 Door (V8 Diesel)
3/07 on
Coil/Leaf

KIT COMPONENTS

Item	Part No.	Qty. per vehicle	Description	List Price EACH
1	TFS-127	2	Front Coil Springs- Standard Height (A)	\$ 126.26
2	TFS-79	2	Front Coil Springs- Raised (B)	\$ 126.26
3	TFR-79	2	Front Coil Springs- Raised Heavy Duty (C)	\$ 150.59
4	TL-80	2	Rear Leaf Springs- Standard Height (A)	\$ 1,142.84
5	TL-80HD	2	Rear Leaf Springs- Raised (B)	\$ 1,279.98
6	TL-80XHD	2	Rear Leaf Springs- Raised Heavy Duty (C)	\$ 1,325.69
7	N72336	1	Rear Urethane Kit- Spring Front Eyes (Non Shell bush)	\$ 59.57
	This P/N only suits Lovells Greasable Shackles/Pins. Does not fit Original Equipment parts.			
8	N72336	1	Rear Urethane Kit- Spring Rear Eyes (Non Shell bush)	\$ 59.57
	This P/N only suits Lovells Greasable Shackles/Pins. Does not fit Original Equipment parts.			
9	N72337	1	Rear Urethane Kit- Spring Shackle	\$ 58.54
	This P/N only suits Lovells Greasable Shackles/Pins. Does not fit Original Equipment parts.			
10	UBL-37	4	Rear U-Bolts	\$ 24.61
11	LGSK388	2	Rear Greasable Shackle Kit	\$ 96.30
12	LGPK388	2	Rear Greasable Pin Kit	\$ 47.08
13	64612491	2	Front Gas Legend Shock Absorber	\$ 272.97
14	64612492	2	Rear Gas Legend Shock Absorber	\$ 270.69
Note: Extra Long Travel Front Gas Legend Shock Absorber option available P/N 64612541 (\$244.02 each)				
Suits C Kit as alternative P/N or Hi Lift Applications where lift exceeds 75mm-100mm (3" - 4")				
Note: Extra Long Travel Rear Gas Legend Shock Absorber option available P/N 64612848 (\$273.30 each)				
Suits C Kit as alternative P/N or Hi Lift Applications where lift exceeds 75mm-100mm (3" - 4")				

SUSPENSION KITS

Kit Type	Part No.	Qty. per vehicle	Kit Description	List Price EACH
A	TOYKIT057-A	1	STANDARD HEIGHT	\$ 4,188.39
B	TOYKIT057-B	1	RAISED	\$ 4,462.67
C	TOYKIT057-C	1	RAISED HEAVY DUTY	\$ 4,602.76

ACCESSORIES (Not included in Kit)

Item	Part No.	Qty. per vehicle	Accessory Description	List Price EACH
1A	N81730	1	Front Urethane Bush Kit- Adjust. Caster Bush	\$ 297.55
2A	N72336-NG	1	Rear Urethane Kit- Spring Front Eyes (SUITS OE Pin)	\$ 250.44
3A	N72336-NG	1	Rear Urethane Kit- Spring Rear Eyes (SUITS OE Shackle)	\$ 250.44
4A	N72337-NG	1	Rear Urethane Kit- Spring Shackle (SUITS OE Shackle)	\$ 126.88
5A	GVM79-Spacer	1	Brake Proportioning Link Spacer	\$ 57.22
6A	HCEB001	1	Rear Handbrake Cable Extension Bracket	\$ 72.39

Highlighted Accessories: Lovells strongly recommend fitting these Part Numbers for all applications.

STEERING DAMPERS (Not included in Kit)

Item	Part No.	Qty. per vehicle	Description	List Price EACH
1B	5450012	1	Steering Damper Assembly- Heavy Duty	\$ 172.53
2B	5450012-RTC	1	Steering Damper Assembly- Return to Centre	\$ 189.75

Part No.	Load Rating	Description
All spring load ratings are an approximate only. Vehicle ride heights will vary depending on load and accessories fitted.		
TFS-127	0 to 100kg Constant Load	Suits Steel Bull Bar
TFS-79	0 to 100kg Constant Load	Suits Steel Bull Bar
TFR-79	100 to 150kg Constant Load	Suits Steel Bull Bar, Winch, Underbody Protection etc.
TL-80	0 to 100kg Constant Load	
TL-80HD	150 to 250kg Constant Load	
TL-80XHD	400 to 500kg Constant Load	

TOYOTA- Landcruiser 70 Series
LC79 Tray Back (V8 Diesel)
3/07 on
Coil/Leaf

SPRAY RIG KIT

KIT COMPONENTS

Item	Part No.	Qty. per vehicle	Description	List Price EACH
1	TFR-79	2	Front Coil Springs- SPRAY RIG (S)	\$ 150.59
2	TL-79SR	2	Rear Leaf Springs- SPRAY RIG (S)	\$ 1,554.26
3	N81730	1	Front Urethane Bush Kit- Adjust. Caster Bush	\$ 297.55
4	N72336	1	Rear Urethane Kit- Spring Front Eyes (Non Shell bush)	\$ 59.57
	This P/N only suits Lovells Greasable Shackles/Pins. Does not fit Original Equipment parts.			
5	N72336	1	Rear Urethane Kit- Spring Rear Eyes (Non Shell bush)	\$ 59.57
	This P/N only suits Lovells Greasable Shackles/Pins. Does not fit Original Equipment parts.			
6	N72337	1	Rear Urethane Kit- Spring Shackle	\$ 58.54
	This P/N only suits Lovells Greasable Shackles/Pins. Does not fit Original Equipment parts.			
7	UBL-37	4	Rear U-Bolts	\$ 24.61
8	LGSK388	2	Rear Greasable Shackle Kit	\$ 96.30
9	LGPk388	2	Rear Greasable Pin Kit	\$ 47.08
10	64612491	2	Front Gas Legend Shock Absorber	\$ 272.97
11	64612492	2	Rear Gas Legend Shock Absorber	\$ 270.69
12	GVM79-Spacer	1	Brake Proportioning Link Spacer	\$ 57.22
13	HCEB001	1	Rear Handbrake Cable Extension Bracket	\$ 72.39
Note: Extra Long Travel Front Gas Legend Shock Absorber option available P/N 64612541 (\$244.02 each)				
Suits above Kit as alternative P/N or Hi Lift Applications where lift exceeds 75mm-100mm (3" - 4")				
Note: Extra Long Travel Rear Gas Legend Shock Absorber option available P/N 64612848 (\$273.30 each)				
Suits above Kit as alternative P/N or Hi Lift Applications where lift exceeds 75mm-100mm (3" - 4")				

SUSPENSION KITS

Kit Type	Part No.	Qty. per vehicle	Kit Description	List Price EACH
S	TOYKIT058-S	1	SPRAY RIG	\$ 5,487.05

Note: Above spring Part Numbers suit alloy tray fitment only. For steel tray Part Numbers please contact Lovells Springs.

STEERING DAMPERS (Not included in Kit)

Item	Part No.	Qty. per vehicle	Description	List Price EACH
1B	5450012	1	Steering Damper Assembly- Heavy Duty	\$ 172.53
2B	5450012-RTC	1	Steering Damper Assembly- Return to Centre	\$ 189.75

Part No.	Load Rating	Description
All spring load ratings are an approximate only. Vehicle ride heights will vary depending on load and accessories fitted.		
TFR-79	100 to 150kg Constant Load	Suits Steel Bull Bar, Winch, Underbody Protection etc.
TL-79SR	500 to 600kg Constant Load	

TOYOTA- Landcruiser 70 Series
LC79 Tray Back (V8 Diesel)
3/07 on
Coil/Leaf

MINING VEHICLE KIT

KIT COMPONENTS

Item	Part No.	Qty. per vehicle	Description	List Price EACH
1	TFR-79	2	Front Coil Springs- MINING VEHICLE (M)	\$ 150.59
2	TL-79XHD	2	Rear Leaf Springs- MINING VEHICLE (M)	\$ 1,417.12
3	N81730	1	Front Urethane Bush Kit- Adjust. Caster Bush	\$ 297.55
4	N72336	1	Rear Urethane Kit- Spring Front Eyes (Non Shell bush)	\$ 59.57
	This P/N only suits Lovells Greasable Shackles/Pins. Does not fit Original Equipment parts.			
5	N72336	1	Rear Urethane Kit- Spring Rear Eyes (Non Shell bush)	\$ 59.57
	This P/N only suits Lovells Greasable Shackles/Pins. Does not fit Original Equipment parts.			
6	N72337	1	Rear Urethane Kit- Spring Shackle	\$ 58.54
	This P/N only suits Lovells Greasable Shackles/Pins. Does not fit Original Equipment parts.			
7	UBL-37	4	Rear U-Bolts	\$ 24.61
8	LGSK388	2	Rear Greasable Shackle Kit	\$ 96.30
9	LGPk388	2	Rear Greasable Pin Kit	\$ 47.08
10	64612491	2	Front Gas Legend Shock Absorber	\$ 272.97
11	64612492	2	Rear Gas Legend Shock Absorber	\$ 270.69
12	GVM79-Spacer	1	Brake Proportioning Link Spacer	\$ 57.22
13	HCEB001	1	Rear Handbrake Cable Extension Bracket	\$ 72.39
Note: Extra Long Travel Front Gas Legend Shock Absorber option available P/N 64612541 (\$244.02 each)				
Suits above Kit as alternative P/N or Hi Lift Applications where lift exceeds 75mm-100mm (3" - 4")				
Note: Extra Long Travel Rear Gas Legend Shock Absorber option available P/N 64612848 (\$273.30 each)				
Suits above Kit as alternative P/N or Hi Lift Applications where lift exceeds 75mm-100mm (3" - 4")				

SUSPENSION KITS

Kit Type	Part No.	Qty. per vehicle	Kit Description	List Price EACH
M	TOYKIT059-M	1	MINING VEHICLE	\$ 5,212.77

Note: Above spring Part Numbers suit alloy tray fitment only. For steel tray Part Numbers please contact Lovells Springs.

STEERING DAMPERS (Not included in Kit)

Item	Part No.	Qty. per vehicle	Description	List Price EACH
1B	5450012	1	Steering Damper Assembly- Heavy Duty	\$ 172.53
2B	5450012-RTC	1	Steering Damper Assembly- Return to Centre	\$ 189.75

Part No.	Load Rating	Description
All spring load ratings are an approximate only. Vehicle ride heights will vary depending on load and accessories fitted.		
TFR-79	100 to 150kg Constant Load	Suits Steel Bull Bar, Winch, Underbody Protection etc.
TL-79XHD	400 to 500kg Constant Load	

TOYOTA- Landcruiser 70 Series
LC78 Troop Carrier (V8 Diesel)
3/07 on
Coil/Leaf



MINING VEHICLE KIT

KIT COMPONENTS

Item	Part No.	Qty. per vehicle	Description	List Price EACH
1	TFR-79	2	Front Coil Springs- MINING VEHICLE (M)	\$ 150.59
2	TL-79XHD	2	Rear Leaf Springs- MINING VEHICLE (M)	\$ 1,417.12
3	N81730	1	Front Urethane Bush Kit- Adjust. Caster Bush	\$ 297.55
4	N72336	1	Rear Urethane Kit- Spring Front Eyes (Non Shell bush)	\$ 59.57
	This P/N only suits Lovells Greasable Shackles/Pins. Does not fit Original Equipment parts.			
5	N72336	1	Rear Urethane Kit- Spring Rear Eyes (Non Shell bush)	\$ 59.57
	This P/N only suits Lovells Greasable Shackles/Pins. Does not fit Original Equipment parts.			
6	N72337	1	Rear Urethane Kit- Spring Shackle	\$ 58.54
	This P/N only suits Lovells Greasable Shackles/Pins. Does not fit Original Equipment parts.			
7	UBL-37	4	Rear U-Bolts	\$ 24.61
8	LGSK388	2	Rear Greasable Shackle Kit	\$ 96.30
9	LGPK388	2	Rear Greasable Pin Kit	\$ 47.08
10	64612491	2	Front Gas Legend Shock Absorber	\$ 272.97
11	64612492	2	Rear Gas Legend Shock Absorber	\$ 270.69
12	GVM79-Spacer	1	Brake Proportioning Link Spacer	\$ 57.22
13	HCEB001	1	Rear Handbrake Cable Extension Bracket	\$ 72.39
Note: Extra Long Travel Front Gas Legend Shock Absorber option available P/N 64612541 (\$244.02 each)				
Suits above Kit as alternative P/N or Hi Lift Applications where lift exceeds 75mm-100mm (3" - 4")				
Note: Extra Long Travel Rear Gas Legend Shock Absorber option available P/N 64612848 (\$273.30each)				
Suits above Kit as alternative P/N or Hi Lift Applications where lift exceeds 75mm-100mm (3" - 4")				

SUSPENSION KITS

Kit Type	Part No.	Qty. per vehicle	Kit Description	List Price EACH
M	TOYKIT060-M	1	MINING VEHICLE	\$ 5,212.77

STEERING DAMPERS (Not included in Kit)

Item	Part No.	Qty. per vehicle	Description	List Price EACH
1B	5450012	1	Steering Damper Assembly- Heavy Duty	\$ 172.53
2B	5450012-RTC	1	Steering Damper Assembly- Return to Centre	\$ 189.75

Part No.	Load Rating	Description
All spring load ratings are an approximate only. Vehicle ride heights will vary depending on load and accessories fitted.		
TFR-79	100 to 150kg Constant Load	Suits Steel Bull Bar, Winch, Underbody Protection etc.
TL-79XHD	400 to 500kg Constant Load	

TOYOTA- Landcruiser 70 Series
LC79 Tray Back (V8 Diesel)- SINGLE CAB
3/07 on
Coil/Leaf

3900KG GVM Upgrade Kit (Fitted Price)

KIT COMPONENTS

Item	Part No.	Qty. per vehicle	Description	SOLD AS KIT ONLY
1	TFS-79	2	Front Coil Springs- GVM UPGRADE (GVM)	
2	TL-79XHD	2	Rear Leaf Springs- GVM UPGRADE (GVM)	
3	N81730	1	Front Urethane Bush Kit- Adjust. Caster Bush	
4	N72336	1	Rear Urethane Kit- Spring Front Eyes (Non Shell bush)	
5	N72336	1	Rear Urethane Kit- Spring Rear Eyes (Non Shell bush)	
6	N72337	1	Rear Urethane Kit- Spring Shackle	
7	UBL-37	4	Rear U-Bolts	
8	LGSK388	2	Rear Greasable Shackle Kit	
9	LGPK388	2	Rear Greasable Pin Kit	
10	64612491	2	Front Gas Legend Shock Absorber	
11	64612492	2	Rear Gas Legend Shock Absorber	
12	GVM79-Spacer	1	Brake Proportioning Link Spacer	
13	HCEB001	1	Rear Handbrake Cable Extension Bracket	
14	77ACMB-LCRUISER70-GVM-IND	2	Category 6 Indicators ADR 13/00	
15		1	3900kg Compliance Plate	
16		1	Proportioning Valve Adjustment Warning Decal	
17		1	3900kg Tyre Loading Placard (Decal)	
18		1	GVM Upgrade Fitting Instructions	

SUSPENSION KITS

Kit Type	Part No.	Qty. per vehicle	Kit Description	Retail Price
GVM	TOYKIT061-GVM-ST	1	GVM Upgrade Kit (Fitted Price) State Compliance	\$ 4,809.00
GVM	TOYKIT061-GVM-J7	1	GVM Upgrade Kit (Fitted Price) Federal or State Compliance	\$ 4,809.00

Note: J7 GVM Kit Does Not Contain Cat 6 Indicators

NOTE: Fitted Price plus GST

Part No.	Load Rating	Description
All spring load ratings are an approximate only. Vehicle ride heights will vary depending on load and accessories fitted.		
TFS-79	100 to 150kg Constant Load	Suits Steel Bull Bar, Winch, Underbody Protection etc.
TL-79XHD	400 to 500kg Constant Load	To GVM

*****NOTE:** The above GVM Upgrade Kit for Federal Compliance under Second Stage Manufacturer Approval, with a Federal compliance plate, is no longer available
 The above kit can still be supplied under State Compliance and will require inspection, by a Lovells endorsed signatory and /or Production Facility.
 Consult your nearest Lovells Production facility for Individual State requirements.

TOYOTA- Landcruiser 70 Series
LC79 Tray Back (V8 Diesel)- DUAL CAB
3/07 on
Coil/Leaf

	3900KG GVM Upgrade Kit (Fitted Price)	
--	--	--

KIT COMPONENTS

Item	Part No.	Qty. per vehicle	Description	SOLD AS KIT ONLY
1	TFS-79	2	Front Coil Springs- GVM UPGRADE (GVM)	
2	TL-79XHD	2	Rear Leaf Springs- GVM UPGRADE (GVM)	
3	N81730	1	Front Urethane Bush Kit- Adjust. Caster Bush	
4	N72336	1	Rear Urethane Kit- Spring Front Eyes (Non Shell bush)	
5	N72336	1	Rear Urethane Kit- Spring Rear Eyes (Non Shell bush)	
6	N72337	1	Rear Urethane Kit- Spring Shackle	
7	UBL-37	4	Rear U-Bolts	
8	LGSK388	2	Rear Greasable Shackle Kit	
9	LGPK388	2	Rear Greasable Pin Kit	
10	64612491	2	Front Gas Legend Shock Absorber	
11	64612492	2	Rear Gas Legend Shock Absorber	
12	GVM79-Spacer	1	Brake Proportioning Link Spacer	
13	HCEB001	1	Rear Handbrake Cable Extension Bracket	
14		1	3900kg Compliance Plate	
15		1	Proportioning Valve Adjustment Warning Decal	
16		1	3900kg Tyre Loading Placard (Decal)	
17		1	GVM Upgrade Fitting Instructions	

SUSPENSION KITS

Kit Type	Part No.	Qty. per vehicle	Kit Description	Retail Price
GVM	TOYKIT079-GVM	1	GVM Upgrade Kit (Fitted Price)	\$ 4,609.00

Part No.	Load Rating	Description
All spring load ratings are an approximate only. Vehicle ride heights will vary depending on load and accessories fitted.		
TFS-79	100 to 150kg Constant Load	Suits Steel Bull Bar, Winch, Underbody Protection etc.
TL-79XHD	400 to 500kg Constant Load	To GVM

The solution for owners/managers of Toyota Landcruiser 70 Series Cab Chassis Dual Cab vehicles who have a need to carry loads to a GVM of 3900kg (up from 3300kg standard GVM), while at the same time meeting the practical and documentary compliance requirements of Work Safety, Police Licensing, Insurance, Lessors and Fleet Managers. This kit is complied by Department of Infrastructure, Transport, Regional Development and Local Government and comes complete with a Second Stage Manufacturer compliance plate. (Australian Compliance ONLY). Federal Compliance GVM Upgrades can only be fitted to vehicles prior to registration. **Lovells Compliance Plate Approval Number (CPA) 25742**

Note: Above price is net and no discounts apply. Lovells Authorised Fitters (holding Production Facility ID) are entitled to a Fitters Price. (Available upon application)

Above price includes fitting by a Lovells Authorised Fitter and does not include GST

*****NOTE: The above GVM Upgrade can be supplied under State Compliance (for already registered vehicles) and the vehicle individually engineered for the State of registration. Includes State engineering certificate or certification plate. Kit part numbers, order forms, details and pricing are available upon application**

TOYOTA- Landcruiser 70 Series

LC79 Tray Back (V8 Diesel)- SINGLE CAB/DUAL CAB

1/17 on (Single Cab) 1/18 on (Dual Cab)

Coil/Leaf

	3900KG GVM Upgrade Kit (Fitted Price)	
--	--	--

KIT COMPONENTS

Item	Part No.	Qty. per vehicle	Description	SOLD AS KIT ONLY
1	TFS-79	2	Front Coil Springs- GVM UPGRADE (GVM)	
2	TL-79PB	2	Rear Leaf Springs- GVM UPGRADE (GVM) Parabolic	
3	N81730	1	Front Urethane Bush Kit- Adjust. Caster Bush	
4	N72336	1	Rear Urethane Kit- Spring Front Eyes (Non Shell bush)	
5	N72336	1	Rear Urethane Kit- Spring Rear Eyes (Non Shell bush)	
6	N72337	1	Rear Urethane Kit- Spring Shackle	
7	UBL-30	4	Rear U-Bolts	
8	LGSK388	2	Rear Greasable Shackle Kit	
9	LGPK388	2	Rear Greasable Pin Kit	
10	64612491	2	Front Gas Legend Shock Absorber	
11	64612492	2	Rear Gas Legend Shock Absorber	
12	HCEB001	1	Rear Handbrake Cable Extension Bracket	
13	77ACMB-LCRUISER70-GVM-IND	2	Category 6 Indicators ADR 13/00	
14		1	Retention U-Bolts Warning (Decal)	
15		2	Lovells Mudflaps (to comply to ADR4204)	
16		1	3900kg Compliance Plate	
17		1	3900kg Tyre Loading Placard (Decal)	
18		1	GVM Upgrade Fitting Instructions	

SUSPENSION KITS

Kit Type	Part No.	Qty. per vehicle	Kit Description	Retail Price
GVM	TOYKIT061-GVM-PB-LC	1	GVM Upgrade Kit (Fitted Price)	\$ 4,500.00
GVM	TOYKIT061-GVM-PB-LC-J7	1	GVM Upgrade Kit (Fitted Price)	\$ 4,500.00

Note: J7 GVM Kit Does Not Contain Cat 6 Indicators

NOTE: Fitted Price plus GST

Part No.	Load Rating	Description
All spring load ratings are an approximate only. Vehicle ride heights will vary depending on load and accessories fitted.		
TFS-79	100 to 150kg Constant Load	Suits Steel Bull Bar, Winch, Underbody Protection etc.

TOYOTA- Landcruiser 70 Series
LC79 Tray Back (V8 Diesel)- SINGLE CAB/DUAL CAB
1/17 on (Single Cab) 1/18 on (Dual Cab)
Coil/Leaf

	4200KG GVM Upgrade Kit (Fitted Price)	
--	--	--

KIT COMPONENTS

Item	Part No.	Qty. per vehicle	Description	SOLD AS KIT ONLY
1	TFS-79	2	Front Coil Springs- GVM UPGRADE (GVM)	
2	TL-79XHD	2	Rear Leaf Springs- GVM UPGRADE (GVM)	
3	N81730	1	Front Urethane Bush Kit- Adjust. Caster Bush	
4	N72336	1	Rear Urethane Kit- Spring Front Eyes (Non Shell bush)	
5	N72336	1	Rear Urethane Kit- Spring Rear Eyes (Non Shell bush)	
6	N72337	1	Rear Urethane Kit- Spring Shackle	
7	UBL-37	4	Rear U-Bolts	
8	LGSK388	2	Rear Greasable Shackle Kit	
9	LGPK388	2	Rear Greasable Pin Kit	
10	64612491	2	Front Gas Legend Shock Absorber	
11	64612492	2	Rear Gas Legend Shock Absorber	
14	HCEB001	1	Rear Handbrake Cable Extension Bracket	
15	77ACMB-LCRUISER70-GVM-IND	2	Category 6 Indicators ADR 13/00	
16		1	4200kg Compliance Plate	
17		1	Proportioning Valve Adjustment Warning Decal	
18		1	4200kg Tyre Loading Placard (Decal)	
19		1	GVM Upgrade Fitting Instructions	

SUSPENSION KITS

Kit Type	Part No.	Qty. per vehicle	Kit Description	Retail Price
GVM	TOYKIT080-GVM	1	GVM Upgrade Kit (Fitted Price) State Compliance	\$ 4,809.00
GVM	TOYKIT080-GVM-J7	1	GVM Upgrade Kit (Fitted Price)	\$ 4,809.00

Note: J7 GVM Kit Does Not Contain Cat 6 Indicators

NOTE: Fitted Price plus GST

Part No.	Load Rating	Description
All spring load ratings are an approximate only. Vehicle ride heights will vary depending on load and accessories fitted.		
TFS-79	100 to 150kg Constant Load	Suits Steel Bull Bar, Winch, Underbody Protection etc.
TL-79XHD	400 to 500kg Constant Load	To GVM

*****NOTE:** The above GVM Upgrade Kit for Federal Compliance under Second Stage Manufacturer Approval, with a Federal compliance plate, is no longer available
 The above kit can still be supplied under State Compliance and will require inspection, by a Lovells endorsed signatory and /or Production Facility.
 Consult your nearest Lovells Production facility for Individual State requirements.

TOYOTA- Landcruiser 70 Series
LC79 Tray Back (V8 Diesel)- SINGLE CAB
1/17-8/22
Coil/Leaf



	4200KG GVM Upgrade Kit (Fitted Price)	
--	--	--

KIT COMPONENTS

Item	Part No.	Qty. per vehicle	Description	SOLD AS KIT ONLY
1	TFS-79	2	Front Coil Springs- GVM UPGRADE (GVM)	
2	TL-79XHD	2	Rear Leaf Springs- GVM UPGRADE (GVM)	
3	N81730	1	Front Urethane Bush Kit- Adjust. Caster Bush	
4	N72336	1	Rear Urethane Kit- Spring Front Eyes (Non Shell bush)	
5	N72336	1	Rear Urethane Kit- Spring Rear Eyes (Non Shell bush)	
6	N72337	1	Rear Urethane Kit- Spring Shackle	
7	UBL-37	4	Rear U-Bolts	
8	LGSK388	2	Rear Greasable Shackle Kit	
9	LGPK388	2	Rear Greasable Pin Kit	
10	64612491-2.0ADJMONO	2	Front 20mm Tube Shock With Remote Reservoir	
11	64612492SL-2.0ADJMONO	1	Rear 20mm Tube Shock With Remote Reservoir	
12	64612492SR-2.0ADJMONO	1	Rear 20mm Tube Shock With Remote Reservoir	
13	HCEB001	1	Rear Handbrake Cable Extension Bracket	
14	77ACMB-LCRUISER70-GVM-IND	2	Category 6 Indicators ADR 13/00	
15		1	4200kg Compliance Plate	
16		1	Proportioning Valve Adjustment Warning Decal	
17		1	4200kg Tyre Loading Placard (Decal)	
18		1	GVM Upgrade Fitting Instructions	

SUSPENSION KITS

Kit Type	Part No.	Qty. per vehicle	Kit Description	Retail Price
GVM	TOYKIT080-GVM-PLAT	1	PLATINUM SERIES GVM Upgrade Kit (Fitted Price)	\$ 5,909.00
GVM	TOYKIT080-GVM-PLAT-J7	1	PLATINUM SERIES GVM Upgrade Kit (Fitted Price)	\$ 5,909.00

Note: J7 GVM Kit Does Not Contain Cat 6 Indicators

NOTE: Fitted Price plus GST

Part No.	Load Rating	Description
All spring load ratings are an approximate only. Vehicle ride heights will vary depending on load and accessories fitted.		
TFS-79	100 to 150kg Constant Load	Suits Steel Bull Bar, Winch, Underbody Protection etc.
TL-79XHD	400 to 500kg Constant Load	To GVM

*****NOTE:** The above GVM Upgrade Kit for Federal Compliance under Second Stage Manufacturer Approval, with a Federal compliance plate, is no longer available
 The above kit can still be supplied under State Compliance and will require inspection, by a Lovells endorsed signatory and /or Production Facility.
 Consult your nearest Lovells Production facility for Individual State requirements.

TOYOTA- Landcruiser 70 Series
LC79 Tray Back (V8 Diesel)- SINGLE CAB
1/17-8/22
Coil/Leaf

4000KG BTC UPGRADE KIT-State Compliance
*****BRAKED TOWING CAPACITY UPGRADE*****

KIT COMPONENTS- STAGE 1

Item	Part No.	Qty. per vehicle	Description	SOLD AS KIT ONLY
1	LSPBTC001A	1	Shank and Tongue Kit (Rated to 4T)	
2	BTCU001-H-2-79	1	Lovells HAULACE All Terrain Hitch (Rated to 5.5T) Including Pillar	
3	BTCU004-T-5	1	Lovells Extra Heavy Duty Towbar Assy (Rated to 4T)	
4	LHA55601A	1	HAULACE AERO S/S H/Brake	
5	LDH55S01A	1	Lovells Drop Shank (Short)	
6	LDH55L01A	1	Lovells Drop Shank (Long)	
7		1	Owners Manual (BTC Upgrade modified vehicles. For glove compartment)	
8		1	BTC Upgrade Fitting Instructions	
9		1	SVI Plate BTC Upgrade	

BTC UPGRADE KITS

Kit Type	Part No.	Qty. per vehicle	Kit Description	
BTC	TOYTOW79001-BTC-ST-2	1	BTC UPGRADE KIT	\$ 3,800.00

TOYOTA- Landcruiser 70 Series
LC79 Tray Back (V8 Diesel)- SINGLE/DUAL CAB
8/22 on
Coil/Leaf



	4200KG GVM Upgrade Kit (Fitted Price)	
--	--	--

KIT COMPONENTS

Item	Part No.	Qty. per vehicle	Description	SOLD AS KIT ONLY
1	TFS-79	2	Front Coil Springs- GVM UPGRADE (GVM)	
2	TL-79XHD	2	Rear Leaf Springs- GVM UPGRADE (GVM)	
3	N81730	1	Front Urethane Bush Kit- Adjust. Caster Bush	
4	N72336	1	Rear Urethane Kit- Spring Front Eyes (Non Shell bush)	
5	N72336	1	Rear Urethane Kit- Spring Rear Eyes (Non Shell bush)	
6	N72337	1	Rear Urethane Kit- Spring Shackle	
7	UBL-37	4	Rear U-Bolts	
8	LGSK388	2	Rear Greasable Shackle Kit	
9	LGPK388	2	Rear Greasable Pin Kit	
10	64612491-2.0ADJMONO	2	Front 20mm Tube Shock With Remote Reservoir	
11	64612492SL-2.0ADJMONO	1	Rear 20mm Tube Shock With Remote Reservoir	
12	64612492SR-2.0ADJMONO	1	Rear 20mm Tube Shock With Remote Reservoir	
13	HCEB001	1	Rear Handbrake Cable Extension Bracket	
14	77ACMB-LCRUISER70-GVM-IND	2	Category 6 Indicators ADR 13/00	
15		1	4200kg Compliance Plate	
16		1	Proportioning Valve Adjustment Warning Decal	
17		1	4200kg Tyre Loading Placard (Decal)	
18		1	GVM Upgrade Fitting Instructions	

SUSPENSION KITS

Kit Type	Part No.	Qty. per vehicle	Kit Description	Retail Price
GVM	TOYKIT080-GVM-PLAT	1	PLATINUM SERIES GVM Upgrade Kit (Fitted Price)	\$ 5,909.00
GVM	TOYKIT080-GVM-PLAT-J7	1	PLATINUM SERIES GVM Upgrade Kit (Fitted Price)	\$ 5,909.00

Note: J7 GVM Kit Does Not Contain Cat 6 Indicators

NOTE: Fitted Price plus GST

Part No.	Load Rating	Description
All spring load ratings are an approximate only. Vehicle ride heights will vary depending on load and accessories fitted.		
TFS-79	0 to 100kg Constant Load	Suits Steel Bull Bar, Winch, Underbody Protection etc.
TL-79XHD	400 to 500kg Constant Load	To GVM

*****NOTE:** The above GVM Upgrade Kit for Federal Compliance under Second Stage Manufacturer Approval, with a Federal compliance plate, is no longer available
 The above kit can still be supplied under State Compliance and will require inspection, by a Lovells endorsed signatory and /or Production Facility.
 Consult your nearest Lovells Production facility for Individual State requirements.

TOYOTA- Landcruiser 70 Series

LC78 Troop Carrier (V8 Diesel)

3/07 on

Coil/Leaf



3900KG GVM Upgrade Kit (Fitted Price)

KIT COMPONENTS

Item	Part No.	Qty. per vehicle	Description	SOLD AS KIT ONLY
1	TFS-79	2	Front Coil Springs- GVM UPGRADE (GVM)	
2	TL-79XHD	2	Rear Leaf Springs- GVM UPGRADE (GVM)	
3	N81730	1	Front Urethane Bush Kit- Adjust. Caster Bush	
4	N72336	1	Rear Urethane Kit- Spring Front Eyes (Non Shell bush)	
5	N72336	1	Rear Urethane Kit- Spring Rear Eyes (Non Shell bush)	
6	N72337	1	Rear Urethane Kit- Spring Shackle	
7	UBL-37	4	Rear U-Bolts	
8	LGSK388	2	Rear Greasable Shackle Kit	
9	LGPK388	2	Rear Greasable Pin Kit	
10	64612491	2	Front Gas Legend Shock Absorber	
11	64612492	2	Rear Gas Legend Shock Absorber	
12	GVM79-Spacer	1	Brake Proportioning Link Spacer	
13	HCEB001	1	Rear Handbrake Cable Extension Bracket	
14	77ACMB-LCRUISER70-GVM-IND	2	Category 6 Indicators ADR 13/00	
15		1	3900kg Compliance Plate	
16		1	Proportioning Valve Adjustment Warning Decal	
17		1	3900kg Tyre Loading Placard (Decal)	
18		1	GVM Upgrade Fitting Instructions	

SUSPENSION KITS

Kit Type	Part No.	Qty. per vehicle	Kit Description	Retail Price
GVM	TOYKIT062-GVM	1	GVM Upgrade Kit (Fitted Price) State Compliance	\$ 4,809.00
GVM	TOYKIT062-GVM-J7	1	GVM Upgrade Kit (Fitted Price) Federal or State Compliance	\$ 4,809.00

Note: J7 GVM Kit Does Not Contain Cat 6 Indicators

NOTE: Fitted Price plus GST

Part No.	Load Rating	Description
All spring load ratings are an approximate only. Vehicle ride heights will vary depending on load and accessories fitted.		
TFS-79	100 to 150kg Constant Load	Suits Steel Bull Bar, Winch, Underbody Protection etc.
TL-79XHD	400 to 500kg Constant Load	To GVM

*****NOTE:** The above GVM Upgrade Kit for Federal Compliance under Second Stage Manufacturer Approval, with a Federal compliance plate, is no longer available
 The above kit can still be supplied under State Compliance and will require inspection, by a Lovells endorsed signatory and /or Production Facility.
 Consult your nearest Lovells Production facility for Individual State requirements.

TOYOTA- Landcruiser 70 Series

LC78 Troop Carrier (V8 Diesel) J7

9/22 on

Coil/Leaf



4200KG GVM Upgrade Kit (Fitted Price)

KIT COMPONENTS

Item	Part No.	Qty. per vehicle	Description	SOLD AS KIT ONLY
1	TFS-79	2	Front Coil Springs- GVM UPGRADE (GVM)	
2	TL-79XHD	2	Rear Leaf Springs- GVM UPGRADE (GVM)	
3	N81730	1	Front Urethane Bush Kit- Adjust. Caster Bush	
4	N72336	1	Rear Urethane Kit- Spring Front Eyes (Non Shell bush)	
5	N72336	1	Rear Urethane Kit- Spring Rear Eyes (Non Shell bush)	
6	N72337	1	Rear Urethane Kit- Spring Shackle	
7	UBL-37	4	Rear U-Bolts	
8	LGSK388	2	Rear Greasable Shackle Kit	
9	LGPK388	2	Rear Greasable Pin Kit	
10	64612491	2	Front Gas Legend Shock Absorber	
11	64612492	2	Rear Gas Legend Shock Absorber	
12	GVM79-Spacer	1	Brake Proportioning Link Spacer	
13	HCEB001	1	Rear Handbrake Cable Extension Bracket	
14	77ACMB-LCRUISER70-GVM-IND	2	Category 6 Indicators ADR 13/00	
15		1	4200kg Compliance Plate	
16		1	Proportioning Valve Adjustment Warning Decal	
17		1	4200kg Tyre Loading Placard (Decal)	
18		1	GVM Upgrade Fitting Instructions	

SUSPENSION KITS

Kit Type	Part No.	Qty. per vehicle	Kit Description	Retail Price
GVM	TOYKIT062-GVM	1	GVM Upgrade Kit (Fitted Price) State Compliance	\$ 4,809.00
GVM	TOYKIT062-GVM-J7	1	GVM Upgrade Kit (Fitted Price) Federal or State Compliance	\$ 4,809.00

Note: J7 GVM Kit Does Not Contain Cat 6 Indicators

NOTE: Fitted Price plus GST

Part No.	Load Rating	Description
All spring load ratings are an approximate only. Vehicle ride heights will vary depending on load and accessories fitted.		
TFS-79	100 to 150kg Constant Load	Suits Steel Bull Bar, Winch, Underbody Protection etc.
TL-79XHD	400 to 500kg Constant Load	To GVM

*****NOTE:** The above GVM Upgrade Kit for Federal Compliance under Second Stage Manufacturer Approval, with a Federal compliance plate, is no longer available
 The above kit can still be supplied under State Compliance and will require inspection, by a Lovells endorsed signatory and /or Production Facility.
 Consult your nearest Lovells Production facility for Individual State requirements.

TOYOTA- Landcruiser 70 Series
LC76 Wagon- 4 Door (V8 Diesel)
3/07 on
Coil/Leaf

3660KG GVM Upgrade Kit (Fitted Price)

KIT COMPONENTS

Item	Part No.	Qty. per vehicle	Description	SOLD AS KIT ONLY
1	TFS-79	2	Front Coil Springs- GVM UPGRADE (GVM)	
2	TL-80XHD	2	Rear Leaf Springs- GVM UPGRADE (GVM)	
3	N81730	1	Front Urethane Bush Kit- Adjust. Caster Bush	
4	N72336	1	Rear Urethane Kit- Spring Front Eyes (Non Shell bush)	
5	N72336	1	Rear Urethane Kit- Spring Rear Eyes (Non Shell bush)	
6	N72337	1	Rear Urethane Kit- Spring Shackle	
7	UBL-37	4	Rear U-Bolts	
8	LGSK388	2	Rear Greasable Shackle Kit	
9	LGPK388	2	Rear Greasable Pin Kit	
10	64612491	2	Front Gas Legend Shock Absorber	
11	64612492	2	Rear Gas Legend Shock Absorber	
12	GVM79-Spacer	1	Brake Proportioning Link Spacer	
13	HCEB001	1	Rear Handbrake Cable Extension Bracket	
14	77ACMB-LCRUISER70-GVM-IND	2	Category 6 Indicators ADR 13/00	
15		1	3510kg Compliance Plate	
16		1	Proportioning Valve Adjustment Warning Decal	
17		1	3510kg Tyre Loading Placard (Decal)	
18		1	GVM Upgrade Fitting Instructions	

SUSPENSION KITS

Kit Type	Part No.	Qty. per vehicle	Kit Description	Retail Price
GVM	TOYKIT057-GVM	1	GVM Upgrade Kit (Fitted Price) State Compliance	\$ 4,809.00
GVM	TOYKIT057-GVM-J7	1	GVM Upgrade Kit (Fitted Price) Federal or State Compliance	\$ 4,809.00

Note: J7 GVM Kit Does Not Contain Cat 6 Indicators

NOTE: Fitted Price plus GST

Part No.	Load Rating	Description
All spring load ratings are an approximate only. Vehicle ride heights will vary depending on load and accessories fitted.		
TFS-79	100 to 150kg Constant Load	Suits Steel Bull Bar, Winch, Underbody Protection etc.
TL-80XHD	400 to 500kg Constant Load	To GVM

*****NOTE:** The above GVM Upgrade Kit for Federal Compliance under Second Stage Manufacturer Approval, with a Federal compliance plate, is no longer available
 The above kit can still be supplied under State Compliance and will require inspection, by a Lovells endorsed signatory and /or Production Facility.
 Consult your nearest Lovells Production facility for Individual State requirements.

TOYOTA- Landcruiser 80 Series
FJ,HJ80 Wagon (Petrol and Diesel)
5/90-7/91
Coil/Coil



KIT COMPONENTS

Item	Part No.	Qty. per vehicle	Description	List Price EACH
1	TFS-43	2	Front Coil Springs- Standard Height (A)	\$ 144.64
2	TFR-43	2	Front Coil Springs- Raised (B)	\$ 144.58
3	TFR-43HD	2	Front Coil Springs- Raised Heavy Duty (C)	\$ 180.75
4	TRS-45	2	Rear Coil Springs- Standard Height (A)	\$ 173.67
5	TRR-45	2	Rear Coil Springs- Raised (B)	\$ 194.64
6	TRR-45HD	2	Rear Coil Springs- Raised Heavy Duty (C)	\$ 244.67
7	64612490	2	Front Gas Legend Shock Absorber	\$ 244.03
8	64612489	2	Rear Gas Legend Shock Absorber	\$ 267.49

SUSPENSION KITS

Kit Type	Part No.	Qty. per vehicle	Kit Description	List Price EACH
A	TOYKIT043-A	1	STANDARD HEIGHT	\$ 1,659.65
B	TOYKIT043-B	1	RAISED	\$ 1,701.48
C	TOYKIT043-C	1	RAISED HEAVY DUTY	\$ 1,873.86

ACCESSORIES (Not included in Kit)

Item	Part No.	Qty. per vehicle	Accessory Description	List Price EACH
1A	N81730	1	Front Urethane Bush Kit- Adjust. Caster Bush	\$ 297.55
2A	LPR007	1	Front Adjustable Panhard Rod Assembly	\$ 491.15
3A	N81697	1	Front Urethane Bush Kit- Rad. Arm to Chassis	\$ 129.67
4A	N21014	1	Front Sway Bar- Link	\$ 34.16
5A	N21175	1	Front Sway Bar- Mount (23mm-measure bar)	\$ 30.95
6A	N21212	1	Front Sway Bar- Mount (25mm-measure bar)	\$ 30.34
7A	LPR008	1	Rear Adjustable Panhard Rod Assembly	\$ 491.15
8A	N61699A	1	Rear Urethane Bush Kit- Trailing Arm Upper	\$ 245.40
9A	N61700A	1	Rear Urethane Bush Kit- Trailing Arm Lower	\$ 215.24
10A	N21014	1	Rear Sway Bar- Link	\$ 34.16
11A	N21212	1	Rear Sway Bar- Mount (25mm)	\$ 30.34
12A	N63043	1	Rear Lower Trailing Arm Assembly	\$ 505.99
13A	N63036	1	Rear Upper Trailing Arm Assembly- Adjustable	\$ 574.03

Highlighted Accessories: Lovells strongly recommend fitting these accessories when using Raised OR Raised Heavy Duty coil springs. Note: Front Adjustable Panhard Rod for Left Hand Drive Vehicles available P/N LPR007LHD (\$400.00 each).

STEERING DAMPERS (Not included in Kit)

Item	Part No.	Qty. per vehicle	Description	List Price EACH
1B	5450011	1	Steering Damper Assembly- Heavy Duty	\$ 143.75
2B	5450011-RTC	1	Steering Damper Assembly- Return to Centre	\$ 201.67

Part No.	Load Rating	Description
All spring load ratings are an approximate only. Vehicle ride heights will vary depending on load and accessories fitted.		
TFS-43	0 to 100kg Constant Load	Suits Steel Bull Bar
TFR-43	0 to 100kg Constant Load	Suits Steel Bull Bar
TFR-43HD	100 to 150kg Constant Load	Suits Steel Bull Bar, Winch, Underbody Protection etc.
TRS-45	0 to 100kg Constant Load	
TRR-45	0 to 100kg Constant Load	
TRR-45HD	150 to 250kg Constant Load	

TOYOTA- Landcruiser 80 Series
FZJ, HZJ80 Wagon (Petrol and Diesel)
8/91-2/98



Coil/Coil

Progressive Rate Coil Spring OPTION

KIT COMPONENTS

Item	Part No.	Qty. per vehicle	Description	List Price EACH
1	TFS-44LTO	2	Front Coil Springs- Standard Height (A)	\$ 261.41
2	TFR-44LTO	2	Front Coil Springs- Raised (B)	\$ 144.58
3	TFR-44HDLTO	2	Front Coil Springs- Raised Heavy Duty (C)	\$ 149.10
4	TRS-47LTO	2	Rear Coil Springs- Standard Height (A)	\$ 177.95
5	TRR-47LTO	2	Rear Coil Springs- Raised (B)	\$ 177.94
6	TRR-47HDLTO	2	Rear Coil Springs- Raised Heavy Duty (C)	\$ 194.64
7	64612490	2	Front Gas Legend Shock Absorber	\$ 244.03
8	64612489	2	Rear Gas Legend Shock Absorber	\$ 267.49

SUSPENSION KITS

Kit Type	Part No.	Qty. per vehicle	Kit Description	List Price EACH
A	TOYKIT044-A	1	STANDARD HEIGHT	\$ 1,901.75
B	TOYKIT044-B	1	RAISED	\$ 1,668.08
C	TOYKIT044-C	1	RAISED HEAVY DUTY	\$ 1,710.51

ACCESSORIES (Not included in Kit)

Item	Part No.	Qty. per vehicle	Accessory Description	List Price EACH
1A	N81730	1	Front Urethane Bush Kit- Adjust. Caster Bush	\$ 297.55
2A	LPR007	1	Front Adjustable Panhard Rod Assembly	\$ 491.15
3A	N81697	1	Front Urethane Bush Kit- Rad. Arm to Chassis	\$ 129.67
4A	N21014	1	Front Sway Bar- Link	\$ 34.16
5A	N21175	1	Front Sway Bar- Mount (23mm-measure bar)	\$ 30.95
6A	N21212	1	Front Sway Bar- Mount (25mm-measure bar)	\$ 30.34
7A	LPR008	1	Rear Adjustable Panhard Rod Assembly	\$ 491.15
8A	N61699A	1	Rear Urethane Bush Kit- Trailing Arm Upper	\$ 245.40
9A	N61700A	1	Rear Urethane Bush Kit- Trailing Arm Lower	\$ 215.24
10A	N21014	1	Rear Sway Bar- Link	\$ 34.16
11A	N21212	1	Rear Sway Bar- Mount (25mm)	\$ 30.34
12A	N63043	1	Rear Lower Trailing Arm Assembly	\$ 505.99
13A	N63036	1	Rear Upper Trailing Arm Assembly- Adjustable	\$ 574.03

Highlighted Accessories: Lovells strongly recommend fitting these accessories when using Raised OR Raised Heavy Duty coil springs. Note: Front Adjustable Panhard Rod for Left Hand Drive Vehicles available P/N LPR007LHD (\$400.00 each).

STEERING DAMPERS (Not included in Kit)

Item	Part No.	Qty. per vehicle	Description	List Price EACH
1B	5450011	1	Steering Damper Assembly- Heavy Duty	\$ 143.75
2B	5450011-RTC	1	Steering Damper Assembly- Return to Centre	\$ 201.67

Part No.	Load Rating	Description
All spring load ratings are an approximate only. Vehicle ride heights will vary depending on load and accessories fitted.		
TFS-44LTO	0 to 100kg Constant Load	Suits Steel Bull Bar
TFR-44LTO	0 to 100kg Constant Load	Suits Steel Bull Bar
TFR-44HDLTO	100 to 150kg Constant Load	Suits Steel Bull Bar, Winch, Underbody Protection etc.
TRS-47LTO	0 to 100kg Constant Load	
TRR-47LTO	0 to 100kg Constant Load	
TRR-47HDLTO	150 to 250kg Constant Load	

TOYOTA- Landcruiser 80 Series
FZJ, HZJ80 Wagon (Petrol and Diesel)
8/91-2/98



Coil/Coil

	Linear Rate Coil Spring <i>OPTION</i>	
--	--	--

KIT COMPONENTS

Item	Part No.	Qty. per vehicle	Description	List Price EACH
1	TFS-44	2	Front Coil Springs- Standard Height (A)	\$ 144.58
2	TFR-44	2	Front Coil Springs- Raised (B)	\$ 144.58
3	TFR-44HD	2	Front Coil Springs- Raised Heavy Duty (C)	\$ 161.27
4	TRS-47	2	Rear Coil Springs- Standard Height (A)	\$ 177.95
5	TRR-47	2	Rear Coil Springs- Raised (B)	\$ 194.64
6	TRR-47HD	2	Rear Coil Springs- Raised Heavy Duty (C)	\$ 244.67
7	64612490	2	Front Gas Legend Shock Absorber	\$ 244.03
8	64612489	2	Rear Gas Legend Shock Absorber	\$ 267.49

SUSPENSION KITS

Kit Type	Part No.	Qty. per vehicle	Kit Description	List Price EACH
A	TOYKIT045-A	1	STANDARD HEIGHT	\$ 1,668.10
B	TOYKIT045-B	1	RAISED	\$ 1,701.47
C	TOYKIT045-C	1	RAISED HEAVY DUTY	\$ 1,834.90

ACCESSORIES (Not included in Kit)

Item	Part No.	Qty. per vehicle	Accessory Description	List Price EACH
1A	N81730	1	Front Urethane Bush Kit- Adjust. Caster Bush	\$ 297.55
2A	LPR007	1	Front Adjustable Panhard Rod Assembly	\$ 491.15
3A	N81697	1	Front Urethane Bush Kit- Rad. Arm to Chassis	\$ 129.67
4A	N21014	1	Front Sway Bar- Link	\$ 34.16
5A	N21175	1	Front Sway Bar- Mount (23mm-measure bar)	\$ 30.95
6A	N21212	1	Front Sway Bar- Mount (25mm-measure bar)	\$ 30.34
7A	LPR008	1	Rear Adjustable Panhard Rod Assembly	\$ 491.15
8A	N61699A	1	Rear Urethane Bush Kit- Trailing Arm Upper	\$ 245.40
9A	N61700A	1	Rear Urethane Bush Kit- Trailing Arm Lower	\$ 215.24
10A	N21014	1	Rear Sway Bar- Link	\$ 34.16
11A	N21212	1	Rear Sway Bar- Mount (25mm)	\$ 30.34
12A	N63043	1	Rear Lower Trailing Arm Assembly	\$ 505.99
13A	N63036	1	Rear Upper Trailing Arm Assembly- Adjustable	\$ 574.03

Highlighted Accessories: Lovells strongly recommend fitting these accessories when using Raised OR Raised Heavy Duty coil springs. Note: Front Adjustable Panhard Rod for Left Hand Drive Vehicles available P/N LPR007LHD (\$400.00 each).

STEERING DAMPERS (Not included in Kit)

Item	Part No.	Qty. per vehicle	Description	List Price EACH
1B	5450011	1	Steering Damper Assembly- Heavy Duty	\$ 143.75
2B	5450011-RTC	1	Steering Damper Assembly- Return to Centre	\$ 201.67

Part No.	Load Rating	Description
All spring load ratings are an approximate only. Vehicle ride heights will vary depending on load and accessories fitted.		
TFS-44	0 to 100kg Constant Load	Suits Steel Bull Bar
TFR-44	0 to 100kg Constant Load	Suits Steel Bull Bar
TFR-44HD	100 to 150kg Constant Load	Suits Steel Bull Bar, Winch, Underbody Protection etc.
TRS-47	0 to 100kg Constant Load	
TRR-47	0 to 100kg Constant Load	
TRR-47HD	150 to 250kg Constant Load	

**TOYOTA- Landcruiser 80 Series
FZJ, HZJ80 Wagon (Petrol and Diesel)
8/91-2/98**



Coil/Coil

KIT COMPONENTS

Item	Part No.	Qty. per vehicle	Description	SOLD AS KIT ONLY
1	TOP80-001	2	Front Coil Springs- Platinum	
2	TOP80-002	2	Rear Coil Springs- Platinum	
3	64612490	2	Front Gas Legend Shock Absorber	
4	64612489	2	Rear Gas Legend Shock Absorber	
5	N81730	1	Front Urethane Bush Kit- Adjust. Caster Bush	
6	LPR007	1	Front Adjustable Panhard Rod Assembly	
7	LPR008	1	Rear Adjustable Panhard Rod Assembly	

SUSPENSION KITS

Kit Type	Part No.	Qty. per vehicle	Kit Description	List Price EACH
Plat	TOYKIT046-Plat	1	PLATINUM SERIES KIT	\$ 3,150.00

*******Lifetime Warranty on Platinum Series Coil Springs*******

Part No.	Load Rating	Description
All spring load ratings are an approximate only. Vehicle ride heights will vary depending on load and accessories fitted.		
TOP80-001	100 to 150kg Constant Load	Suits Steel Bull Bar, Winch, Underbody Protection etc.
TOP80-002	150 to 250kg Constant Load	

Lovells Platinum Series

Lovells Platinum Series Coil Springs are Computer designed and manufactured from centerless ground X4K Premium Onesteel Bar. All coil springs are individually sonically crack tested and are coated in a high gloss Platinum Powder for long life. The Platinum Series Kit is designed for constant load applications, ideally suited for expedition and long haul adventures.

Lovells Platinum Series Kits have been trialed and tested by several high profile Tag Along 4x4 Tour Operators over several years and thousands of arduous kilometers. Lifetime unlimited km warranty on Platinum Series coil springs to the original retail purchaser.

STEERING DAMPERS (Not included in Kit)

Item	Part No.	Qty. per vehicle	Description	List Price EACH
1B	5450011	1	Steering Damper Assembly- Heavy Duty	\$ 143.75
2B	5450011-RTC	1	Steering Damper Assembly- Return to Centre	\$ 201.67

TOYOTA- Landcruiser 100 Series
UZI105 Wagon (Petrol)
3/98-10/07



Torsion Bar/Coil
KIT COMPONENTS

Item	Part No.	Qty. per vehicle	Description	List Price EACH
1	TOY050B	1 Pair	Front Heavy Duty Torsion Bars (Petrol)	\$ 865.26
2	TOY051B	1 Pair	Front Heavy Duty Torsion Bars (Diesel)	\$ 819.72
3	TRR-47LTO	2	Rear Coil Springs- Standard Height (A)	\$ 177.95
4	TRR-47HDLTO	2	Rear Coil Springs- Raised (B)	\$ 194.64
5	TRR-45HD	2	Rear Coil Springs- Raised Heavy Duty (C)	\$ 244.67
6	64612231	2	Front Gas Legend Shock Absorber	\$ 244.03
7	64612230	2	Rear Gas Legend Shock Absorber	\$ 244.03

SUSPENSION KITS

Kit Type	Part No.	Qty. per vehicle	Kit Description	List Price EACH
A	TOYKIT047-A	1	STANDARD HEIGHT (Petrol)	\$ 2,197.27
B	TOYKIT047-B	1	RAISED (Petrol)	\$ 2,230.65
C	TOYKIT047-C	1	RAISED HEAVY DUTY (Petrol)	\$ 2,330.71
	TOYKIT048-A	1	STANDARD HEIGHT (Diesel)	\$ 2,151.73
	TOYKIT048-B	1	RAISED (Diesel)	\$ 2,185.11
	TOYKIT048-C	1	RAISED HEAVY DUTY (Diesel)	\$ 2,000.52

ACCESSORIES (Not included in Kit)

Item	Part No.	Qty. per vehicle	Accessory Description	List Price EACH
1A	N13210	1	Front- Steering Rack & Pinion Mount- 3/98-8/02	\$ 102.45
2A	N13208	1	Front- Steering Rack & Pinion Mount- 9/02 on	\$ 161.50
3A	LPR008	1	Rear Adjustable Panhard Rod Assembly	\$ 491.15
4A	N63043	1	Rear Lower Trailing Arm Assembly	\$ 505.99
5A	N63036	1	Rear Upper Trailing Arm Assembly- Adjustable	\$ 574.03

Highlighted Accessories: Lovells strongly recommend fitting these accessories when using Raised OR Raised Heavy Duty coil springs.

IMPORTANT:

Lovells advise that Torsion Bars on this vehicle must not be raised above OE height as this has the potential to promote failure of either the Torsion Bar Spline Mounts, Lower Control Arm and Shock Absorbers.
The optimum position of the front end is where the shock absorber is positioned in the middle of its stroke. It should also be noted that this vehicle does not come equipped with Upper Bump Stops.

Part No.	Load Rating	Description
All spring load ratings are an approximate only. Vehicle ride heights will vary depending on load and accessories fitted.		
TRR-47LTO	150 to 250kg Constant Load	
TRR-47HDLTO	150 to 250kg Constant Load	

TOYOTA- Landcruiser 100 Series
FZJ, HZJ105 Wagon (Petrol and Diesel)
3/98-10/07
Coil/Coil



Progressive Rate Coil Spring OPTION

KIT COMPONENTS

Item	Part No.	Qty. per vehicle	Description	List Price EACH
1	TFS-44LTO	2	Front Coil Springs- Standard Height (A)	\$ 261.41
2	TFR-44LTO	2	Front Coil Springs- Raised (B)	\$ 144.58
3	TFR-44HDLTO	2	Front Coil Springs- Raised Heavy Duty (C)	\$ 149.10
4	TRS-47LTO	2	Rear Coil Springs- Standard Height (A)	\$ 177.95
5	TRR-47LTO	2	Rear Coil Springs- Raised (B)	\$ 177.95
6	TRR-47HDLTO	2	Rear Coil Springs- Raised Heavy Duty (C)	\$ 194.64
7	64612490	2	Front Gas Legend Shock Absorber	\$ 244.03
8	64612489	2	Rear Gas Legend Shock Absorber	\$ 267.49

SUSPENSION KITS

Kit Type	Part No.	Qty. per vehicle	Kit Description	List Price EACH
A	TOYKIT049-A	1	STANDARD HEIGHT	\$ 1,901.75
B	TOYKIT049-B	1	RAISED	\$ 1,668.10
C	TOYKIT049-C	1	RAISED HEAVY DUTY	\$ 1,710.51

ACCESSORIES (Not included in Kit)

Item	Part No.	Qty. per vehicle	Accessory Description	List Price EACH
1A	N81730	1	Front Urethane Bush Kit- Adjust. Caster Bush	\$ 297.55
2A	LPR007	1	Front Adjustable Panhard Rod Assembly	\$ 491.15
3A	N81697	1	Front Urethane Bush Kit- Rad. Arm to Chassis	\$ 129.67
4A	N21014	1	Front Sway Bar- Link	\$ 34.16
5A	N21175	1	Front Sway Bar- Mount (23mm-measure bar)	\$ 30.95
6A	N21212	1	Front Sway Bar- Mount (25mm-measure bar)	\$ 30.34
7A	LPR008	1	Rear Adjustable Panhard Rod Assembly	\$ 491.15
8A	N61699A	1	Rear Urethane Bush Kit- Trailing Arm Upper	\$ 245.40
9A	N61700A	1	Rear Urethane Bush Kit- Trailing Arm Lower	\$ 215.24
10A	N21014	1	Rear Sway Bar- Link	\$ 34.16
11A	N21212	1	Rear Sway Bar- Mount (25mm)	\$ 30.34
12A	N63043	1	Rear Lower Trailing Arm Assembly	\$ 505.99
13A	N63036	1	Rear Upper Trailing Arm Assembly- Adjustable	\$ 574.03

Highlighted Accessories: Lovells strongly recommend fitting these accessories when using Raised OR Raised Heavy Duty coil springs. Note: Front Adjustable Panhard Rod for Left Hand Drive Vehicles available P/N LPR007LHD (\$400.00 each).

STEERING DAMPERS (Not included in Kit)

Item	Part No.	Qty. per vehicle	Description	List Price EACH
1B	5450011	1	Steering Damper Assembly- Heavy Duty	\$ 143.75
2B	5450011-RTC	1	Steering Damper Assembly- Return to Centre	\$ 201.67

Part No.	Load Rating	Description
All spring load ratings are an approximate only. Vehicle ride heights will vary depending on load and accessories fitted.		
TFS-44LTO	0 to 100kg Constant Load	Suits Steel Bull Bar
TFR-44LTO	0 to 100kg Constant Load	Suits Steel Bull Bar
TFR-44HDLTO	100 to 150kg Constant Load	Suits Steel Bull Bar, Winch, Underbody Protection etc.
TRS-47LTO	0 to 100kg Constant Load	
TRR-47LTO	0 to 100kg Constant Load	
TRR-47HDLTO	150 to 250kg Constant Load	

TOYOTA- Landcruiser 100 Series
FZJ, HZJ105 Wagon (Petrol and Diesel)
3/98-10/07



Coil/Coil

	Linear Rate Coil Spring OPTION	
--	---------------------------------------	--

KIT COMPONENTS

Item	Part No.	Qty. per vehicle	Description	List Price EACH
1	TFS-44	2	Front Coil Springs- Standard Height (A)	\$ 144.58
2	TFR-44	2	Front Coil Springs- Raised (B)	\$ 144.58
3	TFR-44HD	2	Front Coil Springs- Raised Heavy Duty (C)	\$ 161.27
4	TRS-47	2	Rear Coil Springs- Standard Height (A)	\$ 177.95
5	TRR-47	2	Rear Coil Springs- Raised (B)	\$ 194.64
6	TRR-47HD	2	Rear Coil Springs- Raised Heavy Duty (C)	\$ 244.67
7	64612490	2	Front Gas Legend Shock Absorber	\$ 244.03
8	64612489	2	Rear Gas Legend Shock Absorber	\$ 267.49

SUSPENSION KITS

Kit Type	Part No.	Qty. per vehicle	Kit Description	List Price EACH
A	TOYKIT050-A	1	STANDARD HEIGHT	\$ 1,668.10
B	TOYKIT050-B	1	RAISED	\$ 1,701.47
C	TOYKIT050-C	1	RAISED HEAVY DUTY	\$ 1,834.90

ACCESSORIES (Not included in Kit)

Item	Part No.	Qty. per vehicle	Accessory Description	List Price EACH
1A	N81730	1	Front Urethane Bush Kit- Adjust. Caster Bush	\$ 297.55
2A	LPR007	1	Front Adjustable Panhard Rod Assembly	\$ 491.15
3A	N81697	1	Front Urethane Bush Kit- Rad. Arm to Chassis	\$ 129.67
4A	N21014	1	Front Sway Bar- Link	\$ 34.16
5A	N21175	1	Front Sway Bar- Mount (23mm-measure bar)	\$ 30.95
6A	N21212	1	Front Sway Bar- Mount (25mm-measure bar)	\$ 30.34
7A	LPR008	1	Rear Adjustable Panhard Rod Assembly	\$ 491.15
8A	N61699A	1	Rear Urethane Bush Kit- Trailing Arm Upper	\$ 245.40
9A	N61700A	1	Rear Urethane Bush Kit- Trailing Arm Lower	\$ 215.24
10A	N21014	1	Rear Sway Bar- Link	\$ 34.16
11A	N21212	1	Rear Sway Bar- Mount (25mm)	\$ 30.34
12A	N63043	1	Rear Lower Trailing Arm Assembly	\$ 505.99
13A	N63036	1	Rear Upper Trailing Arm Assembly- Adjustable	\$ 574.03

Highlighted Accessories: Lovells strongly recommend fitting these accessories when using Raised OR Raised Heavy Duty coil springs. Note: Front Adjustable Panhard Rod for Left Hand Drive Vehicles available P/N LPR007LHD (\$400.00 each).

STEERING DAMPERS (Not included in Kit)

Item	Part No.	Qty. per vehicle	Description	List Price EACH
1B	5450011	1	Steering Damper Assembly- Heavy Duty	\$ 143.75
2B	5450011-RTC	1	Steering Damper Assembly- Return to Centre	\$ 201.67

Part No.	Load Rating	Description
All spring load ratings are an approximate only. Vehicle ride heights will vary depending on load and accessories fitted.		
TFS-44	0 to 100kg Constant Load	Suits Steel Bull Bar
TFR-44	0 to 100kg Constant Load	Suits Steel Bull Bar
TFR-44HD	100 to 150kg Constant Load	Suits Steel Bull Bar, Winch, Underbody Protection etc.
TRS-47	0 to 100kg Constant Load	
TRR-47	0 to 100kg Constant Load	
TRR-47HD	150 to 250kg Constant Load	

TOYOTA- Landcruiser 100 Series
FZJ, HZJ105 Wagon (Petrol and Diesel)
3/98-10/07



Coil/Coil

KIT COMPONENTS

Item	Part No.	Qty. per vehicle	Description	SOLD AS KIT ONLY
1	TOP80-001	2	Front Coil Springs- Platinum	
2	TOP80-002	2	Rear Coil Springs- Platinum	
3	64612490	2	Front Gas Legend Shock Absorber	
4	64612489	2	Rear Gas Legend Shock Absorber	
5	N81730	1	Front Urethane Bush Kit- Adjust. Caster Bush	
6	LPR007	1	Front Adjustable Panhard Rod Assembly	
7	LPR008	1	Rear Adjustable Panhard Rod Assembly	

SUSPENSION KITS

Kit Type	Part No.	Qty. per vehicle	Kit Description	List Price EACH
Plat	TOYKIT051-Plat	1	PLATINUM SERIES KIT	\$ 3,150.00

*******Lifetime Warranty on Platinum Series Coil Springs*******

Part No.	Load Rating	Description
All spring load ratings are an approximate only. Vehicle ride heights will vary depending on load and accessories fitted.		
TOP80-001	100 to 150kg Constant Load	Suits Steel Bull Bar, Winch, Underbody Protection etc.
TOP80-002	150 to 250kg Constant Load	

Lovells Platinum Series

Lovells Platinum Series Coil Springs are Computer designed and manufactured from centerless ground X4K Premium Onesteel Bar. All coil springs are individually sonically crack tested and are coated in a high gloss Platinum Powder for long life. The Platinum Series Kit is designed for constant load applications, ideally suited for expedition and long haul adventures.

Lovells Platinum Series Kits have been trialled and tested by several high profile Tag Along 4x4 Tour Operators over several years and thousands of arduous kilometers. Lifetime unlimited km warranty on Platinum Series coil springs to the original retail purchaser.

STEERING DAMPERS (Not included in Kit)

Item	Part No.	Qty. per vehicle	Description	List Price EACH
1B	5450011	1	Steering Damper Assembly- Heavy Duty	\$ 143.75
2B	5450011-RTC	1	Steering Damper Assembly- Return to Centre	\$ 201.67

TOYOTA- Landcruiser 200 Series
UZI200 Wagon (Petrol)
09/07 on
Coil/Coil



KIT COMPONENTS

Item	Part No.	Qty. per vehicle	Description	List Price EACH
1	TFS-121	2	Front Coil Springs- Standard Height (A)	\$ 149.10
2	TFR-121	2	Front Coil Springs- Raised (B)	\$ 149.10
3	TFR-123	2	Front Coil Springs- Raised Heavy Duty (C)	\$ 160.96
4	TRS-122	2	Rear Coil Springs- Standard Height (A)	\$ 161.27
5	TRR-122	2	Rear Coil Springs- Raised (B)	\$ 161.27
6	TRR-122HD	2	Rear Coil Springs- Raised Heavy Duty (C)	\$ 177.95
7	64611007	2	Front Gas Legend Strut	\$ 331.71
8	64611008	2	Rear Gas Legend Shock Absorber	\$ 263.97

SUSPENSION KITS

Kit Type	Part No.	Qty. per vehicle	Kit Description	List Price EACH
A	TOYKIT063-A	1	STANDARD	\$ 1,812.10
B	TOYKIT063-B	1	RAISED	\$ 1,812.10
C	TOYKIT063-C	1	RAISED HEAVY DUTY	\$ 1,869.18

IMPORTANT: *Please refer to Page 189 for Tech Bulletin on KDSS Brake Adjustment prior to fitting kit*****

Optional parts

Item	Part No.	Qty. per vehicle	Option Description	List Price EACH
1A	LOVUCA-200	1	Lovells Extreme Upper Control Arm kit	\$ 951.00
			Vehicles with front EBH (Hub to guard) measurement greater than 550mm	

ACCESSORIES (Not included in Kit)

Item	Part No.	Qty. per vehicle	Accessory Description	List Price EACH
1A	N53306	1	Front Urethane Bush Kit- Control Arm- Lower Inner	\$ 167.95
2A	N53307	1	Front Urethane Bush Kit- Control Arm- Upper Inner	\$ 309.35
3A	N63223	1	Rear Urethane Bush Kit- Trailing Arm- Lower	\$ 177.67
4A	N63224	1	Rear Urethane Bush Kit- Trailing Arm- Upper	\$ 147.77
5A	N83229	1	Rear Urethane Bush Kit- Panhard Rod Bush	\$ 55.30
6A	KDSS200-Spacer	1	Strut Top Spacer for KDSS height trim	\$ 188.86
7A	SBS-004	1	Front Sway Bar Spacer Kit (KDSS models)	\$ 105.90

Part No.	Load Rating	Description
All spring load ratings are an approximate only. Vehicle ride heights will vary depending on load and accessories fitted.		
TFS-121	0 to 100kg Constant Load	Suits Steel Bull Bar
TFR-121	0 to 100kg Constant Load	Suits Steel Bull Bar
TFR-123	100 to 150kg Constant Load	Suits Steel Bull Bar, Winch, Underbody Protection etc.
TRS-122	0 to 100kg Constant Load	
TRR-122	0 to 100kg Constant Load	
TRR-122HD	150 to 250kg Constant Load	

TOYOTA- Landcruiser 200 Series
VDJ200 Wagon (Diesel)
09/07 on
Coil/Coil



KIT COMPONENTS

Item	Part No.	Qty. per vehicle	Description	List Price EACH
1	TFR-121	2	Front Coil Springs- Standard Height (A)	\$ 149.10
2	TFR-123	2	Front Coil Springs- Raised (B)	\$ 160.96
3	TFR-123HD	2	Front Coil Springs- Raised Heavy Duty (C)	\$ 165.79
4	TRS-122	2	Rear Coil Springs- Standard Height (A)	\$ 161.27
5	TRR-122	2	Rear Coil Springs- Raised (B)	\$ 161.27
6	TRR-122HD	2	Rear Coil Springs- Raised Heavy Duty (C)	\$ 177.95
7	64611007	2	Front Gas Legend Strut	\$ 331.71
8	64611008	2	Rear Gas Legend Shock Absorber	\$ 263.97

SUSPENSION KITS

Kit Type	Part No.	Qty. per vehicle	Kit Description	List Price EACH
A	TOYKIT068-A	1	STANDARD	\$ 1,812.10
B	TOYKIT068-B	1	RAISED	\$ 1,835.82
C	TOYKIT068-C	1	RAISED HEAVY DUTY	\$ 1,878.83

IMPORTANT: *Please refer to Page 189 for Tech Bulletin on KDSS Brake Adjustment prior to fitting kit*****

Optional parts

Item	Part No.	Qty. per vehicle	Option Description	List Price EACH
1A	LOVUCA-200	1	Lovells Extreme Upper Control Arm kit Vehicles with front EBH (Hub to guard) measurement greater than 550mm	\$ 951.00

ACCESSORIES (Not included in Kit)

Item	Part No.	Qty. per vehicle	Accessory Description	List Price EACH
1A	N53306	1	Front Urethane Bush Kit- Control Arm- Lower Inner	\$ 167.95
2A	N53307	1	Front Urethane Bush Kit- Control Arm- Upper Inner	\$ 309.35
3A	N63223	1	Rear Urethane Bush Kit- Trailing Arm- Lower	\$ 177.67
4A	N63224	1	Rear Urethane Bush Kit- Trailing Arm- Upper	\$ 147.77
5A	N83229	1	Rear Urethane Bush Kit- Panhard Rod Bush	\$ 55.30
6A	KDSS200-Spacer	1	Strut Top Spacer for KDSS height trim	\$ 188.86
7A	SBS-004	1	Front Sway Bar Spacer Kit (KDSS models)	\$ 105.90

Part No.	Load Rating	Description
All spring load ratings are an approximate only. Vehicle ride heights will vary depending on load and accessories fitted.		
TFR-121	0 to 100kg Constant Load	Suits Steel Bull Bar
TFR-123	0 to 100kg Constant Load	Suits Steel Bull Bar
TFR-123HD	150 to 200kg Constant Load	Suits Steel Bull Bar, Winch, Underbody Protection etc.
TRS-122	0 to 100kg Constant Load	
TRR-122	0 to 100kg Constant Load	
TRR-122HD	150 to 250kg Constant Load	

TOYOTA- Landcruiser 200 Series
UZI, VDJ200 Wagon (Petrol and Diesel)
09/07 on
Coil/Coil



GVM Upgrade Kit (Fitted Price)-State Compliance
3800KG

KIT COMPONENTS

Item	Part No.	Qty. per vehicle	Description	SOLD AS KIT ONLY
1	TFR-121	2	Front Coil Springs- Raised (GVM)- (Petrol Engine)	
OR				
1	TFR-123		Front Coil Springs- Raised (GVM)- (Diesel Engine)	
2	TFR-123HD		Front Coil Springs- Raised H/D (GVM)- (Diesel Engine)	
3	TRR-122HD	2	Rear Coil Springs- Raised (GVM)	
OR				
3	TRR-122HDAV	2	Rear Coil Springs- Constant Load (GVM)	
4	64611007	2	Front Gas Legend Strut	
5	64611008	2	Rear Gas Legend Shock Absorber	
6		1	3800kg Compliance Plate	
7		1	KDSS Valve Adjustment Warning Decal	
8		1	3800kg Tyre Loading Placard (Decal)	
9		1	GVM Upgrade Fitting Instructions	

IMPORTANT: Please specify Petrol OR Diesel Engine when ordering and Rear Coil Spring Type.

Optional parts

Item	Part No.	Qty. per vehicle	Option Description	List Price EACH
1A	LOVUCA-200	1	Lovells Extreme Upper Control Arm kit	\$ 951.00
			Vehicles with front EBH (Hub to guard) measurement greater than 550mm	

SUSPENSION KITS

Kit Type	Part No.	Qty. per vehicle	Kit Description	Retail Price
GVM	TOYKIT067-GVM-P	1	GVM Upgrade Kit (Fitted Price)	\$ 3,900.00
GVM	TOYKIT067-GVM-D	1	GVM Upgrade Kit (Fitted Price)	\$ 3,900.00

NOTE: Fitted price plus GST

Part No.	Load Rating	Description
All spring load ratings are an approximate only. Vehicle ride heights will vary depending on load and accessories fitted.		
TFR-121	0 to 100kg Constant Load	Suits Steel Bull Bar
TFR-123	0 to 100kg Constant Load	Suits Steel Bull Bar
TFR-123HD	100 to 150kg Constant Load	Suits Steel Bull Bar
TRR-122HD	150 to 250kg Constant Load	To GVM
TRR-122HDAV	300 to 400kg Constant Load	To GVM

*****NOTE:** The above GVM Upgrade Kit for Federal Compliance under Second Stage Manufacturer Approval, with a Federal compliance plate, is no longer available
 The above kit can still be supplied under State Compliance and will require inspection, by a Lovells endorsed signatory and /or Production Facility.
 Consult your nearest Lovells Production facility for Individual State requirements.

TOYOTA- Landcruiser 200 Series
UZI, VDJ200 Wagon (Petrol and Diesel)
09/07 on
Coil/Coil



GVM Upgrade Kit (Fitted Price)-State Compliance
4000kg

KIT COMPONENTS

Item	Part No.	Qty. per vehicle	Description	List Price EACH
1	TFR-121	2	Front Coil Springs- Raised (GVM)- (Petrol Engine)	
OR				
1	TFR-123		Front Coil Springs- Raised (GVM)- (Diesel Engine)	
2	TRR-122HD	2	Rear Coil Springs- Raised (GVM)	
OR				
3	TRR-122HDAV	2	Rear Coil Springs- Constant Load (GVM)	
4	64611007	2	Front Gas Legend Strut	
5	64611008	2	Rear Gas Legend Shock Absorber	
6		1	4000kg Compliance Plate	
7		1	KDSS Valve Adjustment Warning Decal	
8		1	4000kg Tyre Loading Placard (Decal)	
9		1	GVM Upgrade Fitting Instructions	

IMPORTANT: Please specify Petrol OR Diesel Engine when ordering and Rear Coil Spring Type.

Optional parts

Item	Part No.	Qty. per vehicle	Option Description	List Price EACH
1A	LOVUCA-200	1	Lovells Extreme Upper Control Arm kit	\$ 951.00
			Vehicles with front EBH (Hub to guard) measurement greater than 550mm	

SUSPENSION KITS

Kit Type	Part No.	Qty. per vehicle	Kit Description	Retail Price
GVM	TOYKIT081-GVM-PLAT	1	PLATINUM SERIES GVM Upgrade Kit (Fitted Price)	\$ 4,400.00

NOTE: Fitted price plus GST

Part No.	Load Rating	Description
All spring load ratings are an approximate only. Vehicle ride heights will vary depending on load and accessories fitted.		
TFR-121	0 to 100kg Constant Load	Suits Steel Bull Bar
TFR-123	0 to 100kg Constant Load	Suits Steel Bull Bar
TRR-122HD	150 to 250kg Constant Load	To GVM
TRR-122HDAV	300 to 400kg Constant Load	To GVM

*****NOTE:** The above GVM Upgrade Kit for Federal Compliance under Second Stage Manufacturer Approval, with a Federal compliance plate, is no longer available
 The above kit can still be supplied under State Compliance and will require inspection, by a Lovells endorsed signatory and /or Production Facility.
 Consult your nearest Lovells Production facility for Individual State requirements.

TOYOTA- Landcruiser 200 Series
UZI, VDJ200 Wagon (Petrol and Diesel)
09/07 on
Coil/Coil



KIT COMPONENTS

Item	Part No.	Qty. per vehicle	Description	SOLD AS KIT ONLY
1	TFR-121	2	Front Coil Springs (A,B)	\$ 149.10
	OR			
2	TFR-123	2	Front Coil Springs (C,D)	\$ 160.96
	OR			
3	TFR-123HD	2	Front Coil Springs HD (E,F)	\$ 165.79
	TRR-122HD	2	Rear Coil Springs HD (B,D,F)	\$ 177.95
	OR			
4	TRR-122HDAV	2	Rear Coil Springs HD (A,C,E)	\$ 194.62
5	64611007S-2.0ADJMONO	2	Front 2.0" Mono Tube Strut with Remote Reservoir	\$ 1,033.65
6	64611008S-2.0ADJMONO	2	Rear 2.0" Mono Tube Shock with Remote Reservoir	\$ 998.58

IMPORTANT: Please specify Petrol OR Diesel Engine when ordering and Rear Coil Spring Type.

Optional parts

Item	Part No.	Qty. per vehicle	Option Description	List Price EACH
1A	LOVUCA-200	1	Lovells Extreme Upper Control Arm kit	\$ 951.00
			Vehicles with front EBH (Hub to guard) measurement greater than 550mm	
2A	77ACMB-LCSAHARA-GVM-IND	2	Category 6 Side Indicators to Comply to ADR 13/00	\$ 152.65

SUSPENSION KITS

Kit Type	Part No.	Qty. per vehicle	Kit Description	List Price
A	TOYKIT083-PLAT-A	1	PLATINUM SERIES UPGRADE KIT	\$ 4,751.90
B	TOYKIT083-PLAT-B	1	PLATINUM SERIES UPGRADE KIT	\$ 4,718.56
C	TOYKIT083-PLAT-C	1	PLATINUM SERIES UPGRADE KIT	\$ 4,775.62
D	TOYKIT083-PLAT-D	1	PLATINUM SERIES UPGRADE KIT	\$ 4,742.28
E	TOYKIT083-PLAT-E	1	PLATINUM SERIES UPGRADE KIT	\$ 4,785.28
F	TOYKIT083-PLAT-F	1	PLATINUM SERIES UPGRADE KIT	\$ 4,751.94

Part No.	Load Rating	Description
All spring load ratings are an approximate only. Vehicle ride heights will vary depending on load and accessories fitted.		
TFR-121	0 to 100kg Constant Load	Suits Steel Bull Bar
TFR-123	0 to 100kg Constant Load	Suits Steel Bull Bar
TFR-123HD	150 to 200kg Constant Load	Suits Steel Bull Bar, Winch, Underbody Protection etc.
TRR-122HD	150 to 250kg Constant Load	
TRR-122HDAV	300 to 400kg Constant Load	

TOYOTA- Landcruiser 200 Series
VDJ200 Wagon (Diesel)
09/07 on
Coil/Coil



GVM Upgrade Kit (Fitted Price)-State Compliance
4200kg

KIT COMPONENTS

Item	Part No.	Qty. per vehicle	Description	SOLD AS KIT ONLY
1	TFR-121	2	Front Coil Springs	
Vehicles with minimal or no load bearing front accessories. Axle Capacities under 1600kg				
OR				
2	TFR-123	2	Front Coil Springs	
Vehicles with minimal or no load bearing front accessories eg. Alloy bull bar/winch. Axle capacities between 1580kg and 1700kg				
OR				
3	TFR-123HD	2	Front Coil Springs HD	
Vehicles with load bearing front accessories eg. Steel bull bar/winch/side steps. Axle capacities between 1730kg and 1960kg				
	TRR-122HD	2	Rear Coil Springs HD	
Vehicles with minimal load bearing rear accessories. Axle Capacities under 1600kg				
OR				
4	TRR-122HDAV	2	Rear Coil Springs HD	
Vehicles with minimal load bearing rear accessories. Axle Capacities over 1600kg				
5	64611007S-2.0ADJMONO	2	Front 2.0" Mono Tube Strut with Remote Reservoir	
6	64611008S-2.0ADJMONO	2	Rear 2.0" Mono Tube Shock with Remote Reservoir	
7		1	4200kg Compliance Plate	
8		1	KDSS Valve Adjustment Warning Decal	
9		1	4200kg Tyre Loading Placard (Decal)	
10		1	GVM Upgrade Fitting Instructions	

IMPORTANT: Please specify Petrol OR Diesel Engine when ordering and Rear Coil Spring Type.

Optional parts

Item	Part No.	Qty. per vehicle	Option Description	List Price EACH
1A	LOVUCA-200	1	Lovells Extreme Upper Control Arm kit	\$ 951.00
Vehicles with front EBH (Hub to guard) measurement greater than 550mm				

SUSPENSION KITS

Kit Type	Part No.	Qty. per vehicle	Kit Description	Retail Price
GVM	TOYKIT083-GVM-PLAT	1	PLATINUM SERIES GVM Upgrade Kit (Fitted Price)	\$ 5,550.00

NOTE: Fitted price plus GST

Part No.	Load Rating	Description
All spring load ratings are an approximate only. Vehicle ride heights will vary depending on load and accessories fitted.		
TFR-121	0 to 100kg Constant Load	Suits Steel Bull Bar
TFR-123	0 to 100kg Constant Load	Suits Steel Bull Bar
TFR-123HD	150 to 200kg Constant Load	Suits Steel Bull Bar, Winch, Underbody Protection etc.
TRR-122HD	150 to 250kg Constant Load	To GVM
TRR-122HDAV	300 to 400kg Constant Load	To GVM

*****NOTE:** The above GVM Upgrade Kit for Federal Compliance under Second Stage Manufacturer Approval, with a Federal compliance plate, is no longer available. The above kit can still be supplied under State Compliance and will require inspection, by a Lovells endorsed signatory and /or Production Facility. Consult your nearest Lovells Production facility for Individual State requirements.

TECHNICAL BULLETIN

Kinetic Dynamic Suspension System Adjustment

Subject: TOYOTA LANDCRUISER 200 SERIES – Procedure

Version 2 18th June 2009

Lovells Springs Pty Ltd publish this information in order to maintain safety standards and to assist in correct application and performance of Lovells products.

Please Note:

The Toyota Landcruiser 200 Series and Lexus LX Series are fitted with Toyota's Kinetic Dynamic Suspension System (KDSS), also referred to as "hydro-mechanical semi active anti roll bar". When fitting Lovells Coil Springs and Lovells Gas Legend Shock Absorbers please refer to the following procedures:

1. Suspend vehicle on a 2-post chassis hoist allowing wheels to hang (full droop).
2. Locate the KDSS valve housing. NOTE: The valve housing is located on the left-hand side of the vehicle, on the inside of the chassis rail, approximately halfway between the front and the rear of the vehicle.
3. IMPORTANT: Using a 5mm hex key, check that the two levelling valves are tight in the valve housing (turning clockwise), before going to step 4.
4. Using a 5mm hex key, open the two levelling valves three (3) full rotations in the anti-clockwise direction. (Access is from underside of the KDSS valve)

Note: The KDSS system is now open and the sway bar ends should now be able to be manipulated with Kittle effort, allowing spring/strut removal and installation.

CAUTION: THE VEHICLE MUST NOT BE DRIVEN WITH THESE VALVES OPEN AS THIS WILL COMPROMISE THE SYSTEM AND RENDER THE VEHICLE UNSAFE TO DRIVE.

5. Once Lovells Suspension components are fitted and with the vehicle sitting on level ground, close both KDSS levelling valves by turning them in a clockwise direction to tighten.



KDSS Valve Procedure

TECHNICAL BULLETIN

Kinetic Dynamic Suspension System Equipped Vehicles Fine Tuning of Vehicle Lean

**Subject: TOYOTA LANDCRUISER 200 and TOYOTA PRADO 150
 Procedure (Revision B- 4th July 2019)**

Lovells Springs Pty Ltd publish this information in order to maintain safety standards and to assist in correct application and performance of Lovells products.

Please Note:

The Toyota Landcruiser 200 Series and Toyota Prado 150 Series are fitted with Toyota's Kinetic Suspension System (KDSS), also referred to as "hydro-mechanical semi active anti roll bar". When fitting Lovells Coil Springs and Lovells Gas Legend Shock Absorbers please refer to the following procedures for fine tuning of the inherent vehicle lean which is encountered on approximately 1 in 10 vehicles.

Please take into consideration, KDSS adjusts accordingly to increased spring rates, vehicle load, camber angle of roads, aftermarket rear suspension airbag inflation, resistance and offroading/four wheel driving conditions. Resetting and trimming of KDSS is a serviceable adjustment, not a warrantable repair. If a vehicle develops a lean after initial install, consider the following checks and adjustments.

1. Check original install Data Capture Form to determine the difference of KDSS increased height since install.
 If KDSS has increased (on the passenger side of the vehicle) between 5-10mm perform KDSS reset procedure as per Lovells Install Instructions.
2. If the KDSS system has increased more than 15mm, check if both front struts have equal spacer rings installed on Passenger and Drivers front struts.
3. If both struts have equal spacer rings ie. 10mm or 15mm, you will need to change the offset by 10-15mm subject to load bearing accessories. Remove 10 or 15mm spacer ring on Passenger side front strut spacer ring. Ref images below. Leaving Drivers Struts higher by 10-15mm.
4. This procedure will level the front end heights as close as possible to even (Passenger side to Drivers side). This procedure will also cross counter-leaver Drivers side Front to Passenger side Rear corner. Factory specifications note D/S to P/S offset of up to 12mm is acceptable.
5. Ensure KDSS reset procedure is performed as per Lovells Fitting Instructions when any suspension works are being performed.
6. Should the above procedure not trim heights within 25mm from D/S to P/S, please utilise Lovells P/N KDSS200-Spacer which fits on D/S strut top mount between strut top/top hat and chassis cradle. (LC200 only).
CAUTION: THE FRONT EBH (CENTRE OF HUB TO LIP OF GUARD MEASUREMENT) SHOULD NOT, EXCEED 565mm (LC200), OTHERWISE CORRECT WHEEL ALIGNMENT SPECIFICATIONS MAY NOT BE ACHIEVED, CAUSING PREMATURE TYRE WEAR. BEYOND THIS EBH WILL ALSO INCREASE CV ANGLES WHICH IS NOT RECOMMENDED.



Passenger Side (P/S) Strut Spacers.
 Remove spacer rings to achieve a 10mm-15mm offset between P/S and D/S.

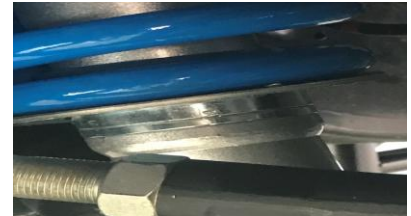

Drivers Side (D/S) Strut Spacers.
 Add spacer rings to achieve a 10mm-15mm offset between D/S and P/S.



Drivers Side (D/S) Strut Top Spacer
 P/N KDSS200-Spacer.
 Add to D/S strut top if D/S to P/S offset exceeds 25mm after first trim procedure (LC200 only).



TOYOTA- Landcruiser 200 Series

UZI, VDJ200 Wagon (Petrol and Diesel)

11/07 on

Coil/Coil

4000KG BTC UPGRADE KIT-State Compliance

*****BRAKED TOWING CAPACITY UPGRADE*****

KIT COMPONENTS- STAGE 1

Item	Part No.	Qty. per vehicle	Description	SOLD AS KIT ONLY
1	LSPBTC001A	1	Shank and Tongue Kit (Rated to 4T)	
2	BTCU001-H-2	1	Lovells HAULACE All Terrain Hitch (Rated to 5T) Includes Pillar	
3	LSPBTC001A	1	Shank and Tongue Kit (Rated to 4T)	
4		1	Federal Compliance Plate for BTC UPGRADE	
5		1	Owners Manual (BTC Upgrade modified vehicles. For glove compartment)	
6		1	BTC Upgrade Fitting Instructions	

KIT COMPONENTS- STAGE 2

Item	Part No.	Qty. per vehicle	Description	SOLD AS KIT ONLY
1	BTCU001-T-2	1	1200LB WDH System	
2	LDH55S01A	1	Drop shank (Short)	
3	LDH55L01A	1	Drop shank (Long)	
4	BTCU001-H-2	1	Lovells HAULACE All Terrain Hitch (Rated to 5T) Includes Pillar	
5	LHA55601A	1	HAULACE AERO S/S H/Brake	
6		1	Federal Compliance Plate for BTC UPGRADE	
7		1	Owners Manual (BTC Upgrade modified vehicles. For glove compartment)	
8		1	BTC Upgrade Fitting Instructions	

BTC UPGRADE KITS

Kit Type	Part No.	Qty. per vehicle	Kit Description	
BTC	TOYTOW001-BTC-ST-1	1	BTC UPGRADE KIT- STAGE 1	\$ 2,900.00
BTC	TOYTOW001-BTC-ST-2	1	BTC UPGRADE KIT- STAGE 2	\$ 3,800.00

The solution for owners/managers of Toyota Landcruiser 200 Series Wagon vehicles who have a need to tow to 4000kg (up from 3500kg standard Braked Towing Capacity), while at the same time meeting the practical and documentary compliance requirements of Work Safety, Police Licensing, Insurance, Lessors and Fleet Managers. This kit is complied by Department of Infrastructure, Transport, Regional Development and Local Government and comes complete with a Second Stage Manufacturer compliance plate. (Australian Compliance ONLY). Federal Compliance BTC Upgrades can only be fitted to vehicles prior to registration and to vehicles fitted with a Lovells 3800kg GVM Upgrade.

BTC Upgrade Compliance Plate Approval Number (CPA) 40257 & 46734

Note: Above price is net and no discounts apply. Lovells Authorised Fitters (holding Production Facility ID) are entitled to a Fitters Price. (Available upon application)

Above price includes fitting by a Lovells Authorised Fitter and does not include GST

Stage 1 Kit- Recommended for towing 3500kg-3700kg Apparatus

Stage 2 Kit- Recommended for towing 3500kg-4000kg Apparatus

TOYOTA- Landcruiser 300 Series
J30T Wagon (Diesel)
07/21 on
Coil/Coil



KIT COMPONENTS

Item	Part No.	Qty. per vehicle	Description	List Price EACH
1	TFS-140	2	Front Coil Springs- Standard Height (A)	\$ 126.26
2	TFR-140	2	Front Coil Springs- Raised (B)	\$ 126.26
3	TFR-140HD	2	Front Coil Springs- Raised Heavy Duty (C and D)	\$ 126.26
4	TRS-141	2	Rear Coil Springs- Standard Height (A)	\$ 126.26
5	TRR-141	2	Rear Coil Springs- Raised (B)	\$ 126.26
6	TRR-141HD	2	Rear Coil Springs- Raised Heavy Duty (C)	\$ 126.26
7	TRR-141EHD	2	Rear Coil Springs- Raised Extra Heavy Duty (D)	\$ 126.26
8	64612855	2	Front Gas Legend Strut	\$ 273.31
9	64612856	2	Rear Gas Legend Shock Absorber	\$ 273.31

SUSPENSION KITS

Kit Type	Part No.	Qty. per vehicle	Kit Description	List Price EACH
A	TOYKIT086-A	1	STANDARD	\$ 1,598.28
B	TOYKIT086-B	1	RAISED	\$ 1,598.28
C	TOYKIT086-C	1	RAISED HEAVY DUTY	\$ 1,598.28
D	TOYKIT086-D	1	RAISED EXTRA HEAVY DUTY	\$ 1,598.28

ACCESSORIES (Not included in Kit)

Item	Part No.	Qty. per vehicle	Accessory Description	List Price EACH
1A	LOVUCA-300	1	Lovells Extreme Upper Control Arm kit	\$ 995.00
			Vehicles with front EBH (Hub to guard) measurement greater than 540mm	

Part No.	Load Rating	Description
All spring load ratings are an approximate only. Vehicle ride heights will vary depending on load and accessories fitted.		
TFS-140	0 to 100kg Constant Load	Suits Steel Bull Bar
TFR-140	0 to 100kg Constant Load	Suits Steel Bull Bar
TFR-140HD	100 to 150kg Constant Load	Suits Steel Bull Bar, Winch, Underbody Protection etc.
TRS-141	0 to 100kg Constant Load	
TRR-141	0 to 100kg Constant Load	
TRR-141HD	150 to 250kg Constant Load	
TRR-141EHD	300 to 400kg Constant Load	

TOYOTA- Landcruiser 300 Series
J30T Wagon (Diesel)
07/21 on
Coil/Coil



KIT COMPONENTS

Item	Part No.	Qty. per vehicle	Description	List Price EACH
1	TFS-140	2	Front Coil Springs- Standard Height (A)	\$ 126.26
2	TFR-140	2	Front Coil Springs- Raised (B)	\$ 126.26
3	TFR-140HD	2	Front Coil Springs- Raised Heavy Duty (C and D)	\$ 126.26
4	TRS-141	2	Rear Coil Springs- Standard Height (A)	\$ 126.26
5	TRR-141	2	Rear Coil Springs- Raised (B)	\$ 126.26
6	TRR-141HD	2	Rear Coil Springs- Raised Heavy Duty (C)	\$ 126.26
7	TRR-141EHD	2	Rear Coil Springs- Raised Extra Heavy Duty (D)	\$ 126.26
8	64612855FL-2.0ADJMONO	1	Front 2.0" Mono Tube Strut with Remote Reservoir	\$ 870.00
9	64612855FR-2.0ADJMONO	1	Front 2.0" Mono Tube Strut with Remote Reservoir	\$ 870.00
10	64612856-2.0ADJMONO	2	Rear 2.0" Mono Tube Shock with Remote Reservoir	\$ 870.00
11	LS-NUTPLATE	2	M8 Nutplate	\$ 17.58
12	LS-NUTPLATE2	3	M6 Nutplate	\$ 23.25
13	1176-200819	4	P Clamp 20mm	\$ 3.05

SUSPENSION KITS

Kit Type	Part No.	Qty. per vehicle	Kit Description	List Price EACH
A	TOYKIT086-PLAT-A	1	STANDARD	\$ 4,102.15
B	TOYKIT086-PLAT-B	1	RAISED	\$ 4,102.15
C	TOYKIT086-PLAT-C	1	RAISED HEAVY DUTY	\$ 4,102.15
D	TOYKIT086-PLAT-D	1	RAISED EXTRA HEAVY DUTY	\$ 4,102.15

ACCESSORIES (Not included in Kit)

Item	Part No.	Qty. per vehicle	Accessory Description	List Price EACH
1A	LOVUCA-300	1	Lovells Extreme Upper Control Arm kit	\$ 995.00
			Vehicles with front EBH (Hub to guard) measurement greater than 540mm	

Part No.	Load Rating	Description
All spring load ratings are an approximate only. Vehicle ride heights will vary depending on load and accessories fitted.		
TFS-140	0 to 100kg Constant Load	Suits Steel Bull Bar
TFR-140	0 to 100kg Constant Load	Suits Steel Bull Bar
TFR-140HD	100 to 150kg Constant Load	Suits Steel Bull Bar, Winch, Underbody Protection etc.
TRS-141	0 to 100kg Constant Load	
TRR-141	0 to 100kg Constant Load	
TRR-141HD	150 to 250kg Constant Load	
TRR-141EHD	300 to 400kg Constant Load	

TOYOTA- Landcruiser 300 Series

J30T Wagon (Diesel)

07/21 on

Coil/Coil

GVM Upgrade Kit (Fitted Price)-Federal Compliance
3560kg

KIT COMPONENTS

Item	Part No.	Qty. per vehicle	Description	SOLD AS KIT ONLY
1	TFS-140	2	Front Coil Springs	
Vehicles with minimal or no load bearing front accessories. Axle Capacities under 1500kg				
OR				
2	TFR-140	2	Front Coil Springs	
Vehicles with minimal or no load bearing front accessories. Axle Capacities under 1500kg				
OR				
3	TRR-141	2	Rear Coil Springs	
Vehicles with minimal load bearing rear accessories. Axle Capacities under 1400kg				
5	64612855	2	Front Gas Legend Strut	
6	64612856	2	Rear Gas Legend Shock Absorber	
7		1	3560kg Compliance Plate (SVI)	
9		1	3560kg Tyre Loading Placard (Decal)	
10		1	GVM Upgrade Fitting Instructions	
11		1	Owners Manual	

Optional parts

Item	Part No.	Qty. per vehicle	Option Description	List Price EACH
1A	LOVUCA-300	1	Lovells Extreme Upper Control Arm kit	\$ 995.00
Vehicles with front EBH (Hub to guard) measurement greater than 540mm				

SUSPENSION KITS

Kit Type	Part No.	Qty. per vehicle	Kit Description	Retail Price
GVM	TOYKIT086-GVM-CMFT	1	COMFORT SERIES GVM Kit (Fitted Price)	\$ 3,300.00

Part No.	Load Rating	Description
All spring load ratings are an approximate only. Vehicle ride heights will vary depending on load and accessories fitted.		
TFS-140	0 to 100kg Constant Load	Suits Steel Bull Bar
TFR-140	0 to 100kg Constant Load	Suits Steel Bull Bar
TRR-141	0 to 100kg Constant Load	To GVM

TOYOTA- Landcruiser 300 Series

J30T Wagon (Diesel)

07/21 on

Coil/Coil

GVM Upgrade Kit (Fitted Price)-Federal Compliance
3800kg

KIT COMPONENTS

Item	Part No.	Qty. per vehicle	Description	SOLD AS KIT ONLY
1	TFS-140	2	Front Coil Springs	
Vehicles with minimal or no load bearing front accessories. Axle Capacities under 1500kg				
OR				
2	TFR-140	2	Front Coil Springs	
Vehicles with minimal or no load bearing front accessories. Axle Capacities under 1500kg				
OR				
3	TRR-141HD	2	Rear Coil Springs Heavy Duty	
Vehicles with minimal load bearing rear accessories. Axle Capacities under 1600kg				
OR				
4	TRR-141EHD	2	Rear Coil Springs Extra Heavy Duty	
Vehicles with minimal load bearing rear accessories. Axle Capacities over 1600kg				
5	64612855	2	Front Gas Legend Strut	
6	64612856	2	Rear Gas Legend Shock Absorber	
7		1	3800kg Compliance Plate (SVI)	
8		1	3800kg Tyre Loading Placard (Decal)	
9		1	GVM Upgrade Fitting Instructions	
10		1	Owners Manual	

Optional parts

Item	Part No.	Qty. per vehicle	Option Description	List Price EACH
1A	LOVUCA-300	1	Lovells Extreme Upper Control Arm kit	\$ 995.00
				Vehicles with front EBH (Hub to guard) measurement greater than 540mm

SUSPENSION KITS

Kit Type	Part No.	Qty. per vehicle	Kit Description	Retail Price
GVM	TOYKIT086-GVM	1	GVM Upgrade Kit (Fitted Price)	\$ 4,400.00

Part No.	Load Rating	Description
All spring load ratings are an approximate only. Vehicle ride heights will vary depending on load and accessories fitted.		
TFR-140	0 to 100kg Constant Load	Suits Steel Bull Bar
TFR-140HD	100 to 150kg Constant Load	Suits Steel Bull Bar, Winch, Underbody Protection etc.
TRR-141HD	150 to 250kg Constant Load	To GVM
TRR-141EHD	300 to 400kg Constant Load	To GVM

TOYOTA- Landcruiser 300 Series

J30T Wagon (Diesel)

07/21 on

Coil/Coil



GVM Upgrade Kit (Fitted Price)-Federal Compliance
4200kg

KIT COMPONENTS

Item	Part No.	Qty. per vehicle	Description	SOLD AS KIT ONLY
1	TFR-140	2	Front Coil Springs	
Vehicles with minimal or no load bearing front accessories. Axle Capacities under 1500kg				
OR				
2	TFR-140HD	2	Front Coil Springs Heavy Duty	
Vehicles with minimal or no load bearing front accessories. Axle Capacities over 1500kg				
OR				
3	TRR-141HD	2	Rear Coil Springs Heavy Duty	
Vehicles with minimal load bearing rear accessories. Axle Capacities under 1600kg				
OR				
4	TRR-141EHD	2	Rear Coil Springs Extra Heavy Duty	
Vehicles with minimal load bearing rear accessories. Axle Capacities over 1600kg				
7	64612855FL-2.0ADJMONO	1	Front 2.0" Mono Tube Strut with Remote Reservoir	
8	64612855FR-2.0ADJMONO	1	Front 2.0" Mono Tube Strut with Remote Reservoir	
9	64612856-2.0ADJMONO	2	Rear 2.0" Mono Tube Shock with Remote Reservoir	
10		1	4200kg Compliance Plate (SVI)	
11		1	4200kg Tyre Loading Placard (Decal)	
12		1	GVM Upgrade Fitting Instructions	
13		1	Owners Manual	

Optional parts

Item	Part No.	Qty. per vehicle	Option Description	List Price EACH
1A	LOVUCA-300	1	Lovells Extreme Upper Control Arm kit	\$ 995.00
Vehicles with front EBH (Hub to guard) measurement greater than 540mm				

SUSPENSION KITS

Kit Type	Part No.	Qty. per vehicle	Kit Description	Retail Price
GVM	TOYKIT087-GVM-PLAT	1	PLATINUM SERIES GVM Upgrade Kit (Fitted Price)	\$ 5,750.00

Part No.	Load Rating	Description
All spring load ratings are an approximate only. Vehicle ride heights will vary depending on load and accessories fitted.		
TFR-140	0 to 100kg Constant Load	Suits Steel Bull Bar
TFR-140HD	100 to 150kg Constant Load	Suits Steel Bull Bar, Winch, Underbody Protection etc.
TRR-141HD	150 to 250kg Constant Load	To GVM
TRR-141EHD	300 to 400kg Constant Load	To GVM

TOYOTA- Prado 90 Series
RZJ, VZJ95 Wagon
7/96-12/02
Coil/Coil



KIT COMPONENTS

Item	Part No.	Qty. per vehicle	Description	List Price EACH
1	TFS-72	2	Front Coil Springs- Standard Height (A)	\$ 126.26
2	TFR-72	2	Front Coil Springs- Raised (B)	\$ 126.26
3	TFR-72HD	2	Front Coil Springs- Raised Heavy Duty (C)	\$ 126.26
4	TRS-73	2	Rear Coil Springs- Standard Height (A)	\$ 126.26
5	TRR-73	2	Rear Coil Springs- Raised (B)	\$ 126.26
6	TRR-73HD	2	Rear Coil Springs- Raised Heavy Duty (C)	\$ 126.26
7	64610088A	2	Front Gas Legend Strut	\$ 326.68
8	64612091E	2	Rear Gas Legend Shock Absorber	\$ 244.03

SUSPENSION KITS

Kit Type	Part No.	Qty. per vehicle	Kit Description	List Price EACH
A	TOYKIT052-A	1	STANDARD HEIGHT	\$ 1,646.45
B	TOYKIT052-B	1	RAISED	\$ 1,646.45
C	TOYKIT052-C	1	RAISED HEAVY DUTY	\$ 1,646.45

ACCESSORIES (Not included in Kit)

Item	Part No.	Qty. per vehicle	Accessory Description	List Price EACH
1A	N22598	1	Front Sway Bar- Mount (24mm-measure bar)	\$ 50.30

Part No.	Load Rating	Description
All spring load ratings are an approximate only. Vehicle ride heights will vary depending on load and accessories fitted.		
TFS-72	0 to 100kg Constant Load	Suits Steel Bull Bar
TFR-72	0 to 100kg Constant Load	Suits Steel Bull Bar
TFR-72HD	100 to 150kg Constant Load	Suits Steel Bull Bar, Winch, Underbody Protection etc.
TRS-73	0 to 100kg Constant Load	
TRR-73	0 to 100kg Constant Load	
TRR-73HD	150 to 250kg Constant Load	

TOYOTA- Prado 120 Series
120 Series Wagon LWB (Diesel- 4 cylinder)
2/03-9/09
Coil/Coil



KIT COMPONENTS

Item	Part No.	Qty. per vehicle	Description	List Price EACH
1	TFS-118	2	Front Coil Springs- Standard Height (A)	\$ 126.26
2	TFR-118	2	Front Coil Springs- Raised (B)	\$ 126.26
3	TFR-118HD	2	Front Coil Springs- Raised Heavy Duty (C)	\$ 126.26
4	TRS-119	2	Rear Coil Springs- Standard Height (A)	\$ 126.26
5	TRR-119	2	Rear Coil Springs- Raised (B)	\$ 126.26
6	TRR-119HD	2	Rear Coil Springs- Raised Heavy Duty (C)	\$ 126.26
7	6467821100	2	Front Gas Legend Strut	\$ 321.11
8	64612548	2	Rear Gas Legend Shock Absorber	\$ 244.03

Note: Extra Long Travel Rear Gas Legend Shock Absorber option available P/N 64612489 (\$227.70 each)
 Use this Part Number with Kit B & C. Please specify at point of order.

SUSPENSION KITS

Kit Type	Part No.	Qty. per vehicle	Kit Description	List Price EACH
A	TOYKIT053-A	1	STANDARD HEIGHT	\$ 1,635.32
B	TOYKIT053-B	1	RAISED	\$ 1,635.32
C	TOYKIT053-C	1	RAISED HEAVY DUTY	\$ 1,635.32

ACCESSORIES (Not included in Kit)

Item	Part No.	Qty. per vehicle	Accessory Description	List Price EACH
1A	N53313	1	Front Urethane Bush Kit- Control Arm- Upper Inner STD	\$ 307.29
2A	N53312	1	Front Urethane Bush Kit- Control Arm- Lower Inner	\$ 406.90
3A	N63215	1	Rear Urethane Bush Kit- Trailing Arm- Upper	\$ 295.74
4A	SBS-003	1	Front Sway Bar Spacer Kit (non-KDSS models)	\$ 105.90

Highlighted Accessories: Lovells strongly recommend fitting these Part Numbers for all applications.

NOTE: Lovells front coil springs will not fit struts with a rolled lower spring seat. For correct fitment always use with a Lovells strut.

Part No.	Load Rating	Description
All spring load ratings are an approximate only. Vehicle ride heights will vary depending on load and accessories fitted.		
TFS-118	0 to 100kg Constant Load	Suits Steel Bull Bar
TFR-118	0 to 100kg Constant Load	Suits Steel Bull Bar
TFR-118HD	100 to 150kg Constant Load	Suits Steel Bull Bar, Winch, Underbody Protection etc.
TRS-119	0 to 100kg Constant Load	
TRR-119	0 to 100kg Constant Load	
TRR-119HD	150 to 250kg Constant Load	

TOYOTA- Prado 120 Series (EXPORT)
120 Series Wagon SWB (Diesel- 4 cylinder)
2/03-9/09
Coil/Coil

KIT COMPONENTS

Item	Part No.	Qty. per vehicle	Description	List Price EACH
1	TFR-118	2	Front Coil Springs- Raised (B)	\$ 126.26
2	TFR-118HD	2	Front Coil Springs- Raised Heavy Duty (C)	\$ 126.26
3	TRR-121	2	Rear Coil Springs- Raised (B)	\$ 126.26
4	TRR-121HD	2	Rear Coil Springs- Raised Heavy Duty (C)	\$ 126.26
5	6467821100	2	Front Gas Legend Strut	\$ 321.11
6	64612489	2	Rear Gas Legend Shock Absorber	\$ 267.49

SUSPENSION KITS

Kit Type	Part No.	Qty. per vehicle	Kit Description	List Price EACH
B	TOYKIT054-B	1	RAISED	\$ 1,682.25
C	TOYKIT054-C	1	RAISED HEAVY DUTY	\$ 1,682.25

ACCESSORIES (Not included in Kit)

Item	Part No.	Qty. per vehicle	Accessory Description	List Price EACH
1A	N53313	1	Front Urethane Bush Kit- Control Arm- Upper Inner STD	\$ 307.29
2A	N53312	1	Front Urethane Bush Kit- Control Arm- Lower Inner	\$ 406.90
3A	N63215	1	Rear Urethane Bush Kit- Trailing Arm- Upper	\$ 295.74
4A	SBS-003	1	Front Sway Bar Spacer Kit (non-KDSS models)	\$ 105.90

Highlighted Accessories: Lovells strongly recommend fitting these Part Numbers for all applications.

NOTE: Lovells front coil springs will not fit struts with a rolled lower spring seat. For correct fitment always use with a Lovells strut.

Part No.	Load Rating	Description
All spring load ratings are an approximate only. Vehicle ride heights will vary depending on load and accessories fitted.		
TFR-118	0 to 100kg Constant Load	Suits Steel Bull Bar
TFR-118HD	100 to 150kg Constant Load	Suits Steel Bull Bar, Winch, Underbody Protection etc.
TRR-121	0 to 100kg Constant Load	
TRR-121HD	150 to 250kg Constant Load	

TOYOTA- Prado 120 Series
120 Series Wagon LWB (Petrol- 6 cylinder)
2/03-9/09
Coil/Coil



KIT COMPONENTS

Item	Part No.	Qty. per vehicle	Description	List Price EACH
1	TFR-118	2	Front Coil Springs- Standard Height (A)	\$ 126.26
2	TFR-118HD	2	Front Coil Springs- Raised (B)	\$ 126.26
3	TFR-118EHD	2	Front Coil Springs- Raised Heavy Duty (C)	\$ 165.77
4	TRS-119	2	Rear Coil Springs- Standard Height (A)	\$ 126.26
5	TRR-119	2	Rear Coil Springs- Raised (B)	\$ 126.26
6	TRR-119HD	2	Rear Coil Springs- Raised Heavy Duty (C)	\$ 126.26
7	6467821100	2	Front Gas Legend Strut	\$ 321.11
8	64612548	2	Rear Gas Legend Shock Absorber	\$ 244.03

Note: Extra Long Travel Rear Gas Legend Shock Absorber option available P/N 64612489 (\$198.00 each)
 Use this Part Number with Kit B & C. Please specify at point of order.

SUSPENSION KITS

Kit Type	Part No.	Qty. per vehicle	Kit Description	List Price EACH
A	TOYKIT071-A	1	STANDARD HEIGHT	\$ 1,635.32
B	TOYKIT071-B	1	RAISED	\$ 1,635.32
C	TOYKIT071-C	1	RAISED HEAVY DUTY	\$ 1,714.34

ACCESSORIES (Not included in Kit)

Item	Part No.	Qty. per vehicle	Accessory Description	List Price EACH
1A	N53313	1	Front Urethane Bush Kit- Control Arm- Upper Inner STD	\$ 307.29
2A	N53312	1	Front Urethane Bush Kit- Control Arm- Lower Inner	\$ 406.90
3A	N63215	1	Rear Urethane Bush Kit- Trailing Arm- Upper	\$ 295.74
4A	SBS-003	1	Front Sway Bar Spacer Kit (non-KDSS models)	\$ 105.90

Part No.	Load Rating	Description
All spring load ratings are an approximate only. Vehicle ride heights will vary depending on load and accessories fitted.		
TFR-118	0 to 100kg Constant Load	Suits Steel Bull Bar
TFR-118HD	100 to 150kg Constant Load	Suits Steel Bull Bar, Winch, Underbody Protection etc.
TFR-118EHD	150 to 200kg Constant Load	Suits Steel Bull Bar, Winch, Underbody Protection etc.
TRS-119	0 to 100kg Constant Load	
TRR-119	0 to 100kg Constant Load	
TRR-119HD	150 to 250kg Constant Load	

TOYOTA- Prado 120 Series (EXPORT)
120 Series Wagon SWB (Petrol- 6 cylinder)
2/03-9/09
Coil/Coil

KIT COMPONENTS

Item	Part No.	Qty. per vehicle	Description	List Price EACH
1	TFR-118HD	2	Front Coil Springs- Raised (B)	\$ 126.26
2	TFR-118EHD	2	Front Coil Springs- Raised Heavy Duty (C)	\$ 165.77
3	TRR-121	2	Rear Coil Springs- Raised (B)	\$ 126.26
4	TRR-121HD	2	Rear Coil Springs- Raised Heavy Duty (C)	\$ 126.26
5	6467821100	2	Front Gas Legend Strut	\$ 321.11
6	64612489	2	Rear Gas Legend Shock Absorber	\$ 267.49

SUSPENSION KITS

Kit Type	Part No.	Qty. per vehicle	Kit Description	List Price EACH
B	TOYKIT072-B	1	RAISED	\$ 1,682.25
C	TOYKIT072-C	1	RAISED HEAVY DUTY	\$ 1,761.27

ACCESSORIES (Not included in Kit)

Item	Part No.	Qty. per vehicle	Accessory Description	List Price EACH
1A	N53313	1	Front Urethane Bush Kit- Control Arm- Upper Inner STD	\$ 307.29
2A	N53312	1	Front Urethane Bush Kit- Control Arm- Lower Inner	\$ 406.90
3A	N63215	1	Rear Urethane Bush Kit- Trailing Arm- Upper	\$ 295.74
4A	SBS-003	1	Front Sway Bar Spacer Kit (non-KDSS models)	\$ 105.90

Highlighted Accessories: Lovells strongly recommend fitting these Part Numbers for all applications.

NOTE: Lovells front coil springs will not fit struts with a rolled lower spring seat. For correct fitment always use with a Lovells strut.

Part No.	Load Rating	Description
All spring load ratings are an approximate only. Vehicle ride heights will vary depending on load and accessories fitted.		
TFR-118	0 to 100kg Constant Load	Suits Steel Bull Bar
TFR-118HD	100 to 150kg Constant Load	Suits Steel Bull Bar, Winch, Underbody Protection etc.
TFR-118EHD	150 to 200kg Constant Load	Suits Steel Bull Bar, Winch, Underbody Protection etc.
TRR-121	0 to 100kg Constant Load	
TRR-121HD	150 to 250kg Constant Load	

TOYOTA- Prado 150 Series
150 Series Wagon LWB (Diesel- 4 cylinder)
10/09 on
Coil/Coil

KIT COMPONENTS

Item	Part No.	Qty. per vehicle	Description	List Price EACH
1	TFS-118	2	Front Coil Springs- Standard Height (A)	\$ 126.26
2	TFR-118	2	Front Coil Springs- Raised (B)	\$ 126.26
3	TFR-118HD	2	Front Coil Springs- Raised Heavy Duty (C)	\$ 126.26
4	TRS-119	2	Rear Coil Springs- Standard Height (A)	\$ 126.26
5	TRR-119	2	Rear Coil Springs- Raised (B)	\$ 126.26
6	TRR-119HD	2	Rear Coil Springs- Raised Heavy Duty (C)	\$ 126.26
7	64610087F	2	Front Gas Legend Strut	\$ 332.11
8	64612489	2	Rear Gas Legend Shock Absorber	\$ 267.49

Note:
 Vehicles fitted/optioned with KDSS (Kinetic Dynamic Suspension Systems), use 20mm strut spacer (supplied with Strut) on Drivers Side only and omit spacer on Passenger Side to ensure correct vehicle trim.

SUSPENSION KITS

Kit Type	Part No.	Qty. per vehicle	Kit Description	List Price EACH
A	TOYKIT074-A	1	STANDARD HEIGHT	\$ 1,704.24
B	TOYKIT074-B	1	RAISED	\$ 1,704.24
C	TOYKIT074-C	1	RAISED HEAVY DUTY	\$ 1,704.24

Optional parts

Item	Part No.	Qty. per vehicle	Option Description	List Price EACH
1A	LOVUCA-PRA	1	Lovells Extreme Upper Control Arm kit	\$ 920.00

ACCESSORIES (Not included in Kit)

Item	Part No.	Qty. per vehicle	Accessory Description	List Price EACH
1A	N53313	1	Front Urethane Bush Kit- Control Arm- Upper Inner STD	\$ 307.29
2A	N53312	1	Front Urethane Bush Kit- Control Arm- Lower Inner	\$ 406.90
3A	N63215	1	Rear Urethane Bush Kit- Trailing Arm- Upper	\$ 295.74
4A	SBS-003	1	Front Sway Bar Spacer Kit (non-KDSS models)	\$ 105.90

Highlighted Accessories: Lovells strongly recommend fitting these Part Numbers for all applications.
NOTE: Lovells front coil springs will not fit struts with a rolled lower spring seat. For correct fitment always use with a Lovells strut.

Part No.	Load Rating	Description
All spring load ratings are an approximate only. Vehicle ride heights will vary depending on load and accessories fitted.		
TFS-118	0 to 100kg Constant Load	Suits Steel Bull Bar
TFR-118	0 to 100kg Constant Load	Suits Steel Bull Bar
TFR-118HD	100 to 150kg Constant Load	Suits Steel Bull Bar, Winch, Underbody Protection etc.
TRS-119	0 to 100kg Constant Load	
TRR-119	0 to 100kg Constant Load	
TRR-119HD	150 to 250kg Constant Load	

TOYOTA- Prado 150 Series
150 Series Wagon LWB (Petrol- 6 cylinder)
10/09 on
Coil/Coil

KIT COMPONENTS

Item	Part No.	Qty. per vehicle	Description	List Price EACH
1	TFR-118	2	Front Coil Springs- Standard Height (A)	\$ 126.26
2	TFR-118HD	2	Front Coil Springs- Raised (B)	\$ 126.26
3	TFR-118EHD	2	Front Coil Springs- Raised Heavy Duty (C)	\$ 165.77
4	TRS-119	2	Rear Coil Springs- Standard Height (A)	\$ 126.26
5	TRR-119	2	Rear Coil Springs- Raised (B)	\$ 126.26
6	TRR-119HD	2	Rear Coil Springs- Raised Heavy Duty (C)	\$ 126.26
7	64610087F	2	Front Gas Legend Strut	\$ 332.11
8	64612489	2	Rear Gas Legend Shock Absorber	\$ 267.49

Note:
 Vehicles fitted/optioned with KDSS (Kinetic Dynamic Suspension Systems), use 20mm strut spacer (supplied with Strut) on Drivers Side only and omit spacer on Passenger Side to ensure correct vehicle trim.

SUSPENSION KITS

Kit Type	Part No.	Qty. per vehicle	Kit Description	List Price EACH
A	TOYKIT075-A	1	STANDARD HEIGHT	\$ 1,704.24
B	TOYKIT075-B	1	RAISED	\$ 1,704.24
C	TOYKIT075-C	1	RAISED HEAVY DUTY	\$ 1,783.26

Optional parts

Item	Part No.	Qty. per vehicle	Option Description	List Price EACH
1A	LOVUCA-PRA	1	Lovells Extreme Upper Control Arm kit	\$ 920.00

ACCESSORIES (Not included in Kit)

Item	Part No.	Qty. per vehicle	Accessory Description	List Price EACH
1A	N53313	1	Front Urethane Bush Kit- Control Arm- Upper Inner STD	\$ 307.29
2A	N53312	1	Front Urethane Bush Kit- Control Arm- Lower Inner	\$ 406.90
3A	N63215	1	Rear Urethane Bush Kit- Trailing Arm- Upper	\$ 295.74
4A	SBS-003	1	Front Sway Bar Spacer Kit (non-KDSS models)	\$ 105.90

Highlighted Accessories: Lovells strongly recommend fitting these Part Numbers for all applications.

NOTE: Lovells front coil springs will not fit struts with a rolled lower spring seat. For correct fitment always use with a Lovells strut.

Part No.	Load Rating	Description
All spring load ratings are an approximate only. Vehicle ride heights will vary depending on load and accessories fitted.		
TFR-118	0 to 100kg Constant Load	Suits Steel Bull Bar
TFR-118HD	100 to 150kg Constant Load	Suits Steel Bull Bar, Winch, Underbody Protection etc.
TFR-118EHD	150 to 200kg Constant Load	Suits Steel Bull Bar, Winch, Underbody Protection etc.
TRS-119	0 to 100kg Constant Load	
TRR-119	0 to 100kg Constant Load	
TRR-119HD	150 to 250kg Constant Load	

TOYOTA- Prado 150 Series

Wagon

10/09 on

Coil/Coil

3500KG GVM Upgrade Kit (Fitted Price)-Federal Compliance

KIT COMPONENTS

Item	Part No.	Qty. per vehicle	Description	SOLD AS KIT ONLY
1	TFR-118HD	2	Front Coil Springs- Raised (GVM)- (Petrol Engine)	
2	TRR-119HD	2	Rear Coil Springs- Raised (GVM)	
4	64610087F	2	Front Gas Legend Strut	
5	64612489	2	Rear Gas Legend Shock Absorber	
6		1	3500kg Compliance Plate	
7		1	Proportioning Valve Adjustment Warning Decal	
8		1	3500kg Tyre Loading Placard (Decal)	
9		1	GVM Upgrade Fitting Instructions	

IMPORTANT: Please specify Rear Coil Spring Type.

SUSPENSION KITS

Kit Type	Part No.	Qty. per vehicle	Kit Description	Retail Price
GVM	TOYKIT078-GVM	1	GVM Upgrade Kit (Fitted Price)	\$ 3,900.00

NOTE: Lovells front coil springs will not fit struts with a rolled lower spring seat. For correct fitment always use with a Lovells strut.

Optional parts

Item	Part No.	Qty. per vehicle	Option Description	List Price EACH
1A	LOVUCA-PRA	1	Lovells Extreme Upper Control Arm kit	\$ 920.00

Part No.	Load Rating	Description
All spring load ratings are an approximate only. Vehicle ride heights will vary depending on load and accessories fitted.		
TFR-118HD	100 to 150kg Constant Load	Suits Steel Bull Bar, Winch, Underbody Protection etc.
TRR-119HD	150 to 250kg Constant Load	To GVM
TRR-119EHD	250 to 300kg Constant Load	To GVM

The solution for owners/managers of Toyota Prado 150 Series Wagon vehicles who have a need to carry loads to a GVM of 3500kg (up from 3000kg standard GVM), while at the same time meeting the practical and documentary compliance requirements of Work Safety, Police Licensing, Insurance, Lessors and Fleet Managers. This kit is complied by Department of Infrastructure, Transport, Regional Development and Local Government and comes complete with a secondary manufacturers compliance plate. (Australian Compliance ONLY). Federal Compliance GVM Upgrades can only be fitted to vehicles prior to registration. **Lovells Compliance Plate Approval Number (CPA) 48305**

Note: Above price is net and no discounts apply. Lovells Authorised Fitters (holding Production Facility ID) are entitled to a Fitters Price. (Available upon application)

Above price includes fitting by a Lovells Authorised Fitter and does not include GST

*****NOTE:** The above GVM Upgrade can be supplied under State Compliance (for already registered vehicles) and the vehicle individually engineered for the State of registration. Includes State engineering certificate or certification plate. Kit part numbers, order forms, details and pricing are available upon application

VOLKSWAGEN- Amarok
2H Pick Up
2/11-12/15
Coil/Leaf

KIT COMPONENTS

Item	Part No.	Qty. per vehicle	Description	List Price EACH
1	VFR-37	2	Front Coil Springs- Raised (B)	\$ 126.26
2	VFR-37HD	2	Front Coil Springs- Raised Heavy Duty (C)	\$ 126.26
3	VWR-001	2	Rear Leaf Springs- Raised (B)	\$ 777.13
4	VWR-001HD	2	Rear Leaf Springs- Raised Heavy Duty (C)	\$ 822.84
5	N73391	1	Rear Urethane Bush Kit- Spring Front eyes	\$ 127.88
6	N73393	1	Rear Urethane Bush Kit- Spring Rear eye	\$ 229.31
7	N73449	1	Rear Urethane Bush Kit- Spring Rear shackle	\$ 133.01
8	UBL-18	4	Rear U-Bolts	\$ 24.61
9	64611040	2	Front Gas Legend Strut	\$ 321.11
10	64611041	2	Rear Gas Legend Shock Absorber	\$ 244.03

SUSPENSION KITS

Kit Type	Part No.	Qty. per vehicle	Kit Description	List Price EACH
B	VOLKIT001-B	1	RAISED	\$ 3,525.70
C	VOLKIT001-C	1	RAISED HEAVY DUTY	\$ 3,617.13

Part No.	Load Rating	Description
All spring load ratings are an approximate only. Vehicle ride heights will vary depending on load and accessories fitted.		
VFR-37	0 to 100kg Constant Load	Suits Steel Bull Bar
VFR-37HD	150 to 250kg Constant Load	Suits Steel Bull Bar, Winch, Underbody Protection etc.
VWR-001	0 to 100kg Constant Load	
VWR-001HD	150 to 250kg Constant Load	

VOLKSWAGEN- Amarok

**Pick Up
 1/16 on
 Coil/Leaf**

KIT COMPONENTS

Item	Part No.	Qty. per vehicle	Description	List Price EACH
1	VFR-37HD	2	Front Coil Springs- Raised (B)	\$ 126.26
2	VFR-37EHD	2	Front Coil Springs- Raised Heavy Duty (C)	\$ 126.26
3	VWR-001	2	Rear Leaf Springs- Raised (B)	\$ 777.13
4	VWR-001HD	2	Rear Leaf Springs- Raised Heavy Duty (C)	\$ 822.84
5	N73391	1	Rear Urethane Bush Kit- Spring Front eyes	\$ 127.88
6	N73393	1	Rear Urethane Bush Kit- Spring Rear eye	\$ 229.31
7	N73449	1	Rear Urethane Bush Kit- Spring Rear shackle	\$ 133.01
8	UBL-18	4	Rear U-Bolts	\$ 24.61
9	64611040	2	Front Gas Legend Strut	\$ 321.11
10	64611041	2	Rear Gas Legend Shock Absorber	\$ 244.03

SUSPENSION KITS

Kit Type	Part No.	Qty. per vehicle	Kit Description	List Price EACH
B	VOLKIT002-B	1	RAISED	\$ 3,525.70
C	VOLKIT002-C	1	RAISED HEAVY DUTY	\$ 3,617.13

Part No.	Load Rating	Description
All spring load ratings are an approximate only. Vehicle ride heights will vary depending on load and accessories fitted.		
VFR-37	0 to 100kg Constant Load	Suits Steel Bull Bar
VFR-37HD	150 to 250kg Constant Load	Suits Steel Bull Bar, Winch, Underbody Protection etc.
VWR-001	0 to 100kg Constant Load	
VWR-001HD	150 to 250kg Constant Load	

4X4 SUSPENSION KIT CATALOGUE

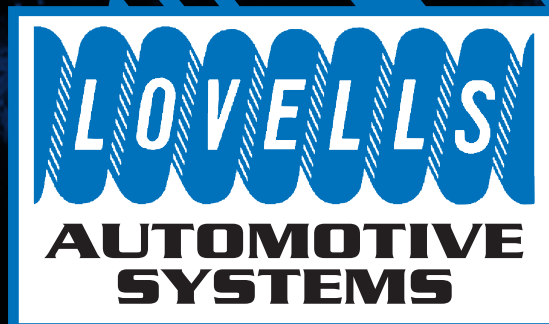

Index

INTRODUCTION

General Information

The Company

Why Springs are Replaced

Suspension Range

Ride Height Options

Customer Specific Design

Part Number Interpretation

Glossary

Catalogue Information

Copyright

Bibliography

Application Index

1-6

Vehicle Application Listing



2020 - VERSION

COIL SPRINGS, LEAF SPRINGS,

URETHANE BUSHINGS,

SHOCK ABSORBERS, STEERING DAMPERS,

TORSION BARS, PANHARD RODS, SHACKLES,

PINS, U-BOLTS & GVM UPGRADE KITS

Lovells Automotive Systems Pty. Ltd.

A.B.N. 82 139 985 603

Int Ph: **+61 2 9820 6800** Int Fax: **+61 2 9820 6788**

website: www.lovellsauto.com.au

email: sales@lovells.com.au

LOVELLS

SUSPENSION

FOR THE RIDE OF YOUR LIFE

The Company

In the commercially dark and uncertain days of the depression. Lovells Springs founder, George Lovell, took the courageous step of leaving the corporate security of Pioneer Railway Springs Pty Ltd to begin with his three sons, his own company in 1930.

George and his sons manufactured their own spring making equipment including furnaces and forming equipment and as a result of hard work, Australian ingenuity and determination the business flourished. Lovells has cemented their reputation as a world leader, manufacturer and supplier of premium quality springs and suspension components to suit a broad range of applications for automotive, defence, agriculture, mining and railway industries.

The company's philosophy of 'up to a standard, not down to a price' paired with a commitment to customer satisfaction and continuous improvement, provide basis for the quality of product, as well as the quality of business relationships developed with their clients.

Why Springs are Replaced



To achieve improvements in the following areas:

- ◆ Ride Height
- ◆ Handling
- ◆ Load Carrying Capacity
- ◆ Comfort
- ◆ **Ride Height**

To restore a vehicle to its original standard ride height, when the original springs have sagged or weakened. To lower the centre of gravity of the vehicle for enhanced appearance, performance and handling characteristics. To raise the vehicle for increased ground clearance and load carrying capabilities eg. offroad applications, towing, LPG tanks, load bearing accessories.

◆ **Handling**

Lovells Springs ratings exceed that of original equipment springs by around 10%-50% (depending on the application), therefore handling is dramatically improved by controlling excessive body roll and brake dive.

◆ **Load Carrying Capacity**

Lovells offer a vast range of heavy duty uprated coil and leaf springs to increase the vehicles load carrying capabilities and maintain stability when laden. These springs should be selected where a vehicle carries heavy loads, is used for towing, is fitted with LPG or larger fuel tank and other Load Bearing Accessories ie Bull Bar, winch, roof rack etc.

◆ **Comfort**

Lovells offer a range of variances in progressive and linear rate coil spring design, ratings and ride height options to enable the vehicle to be enhanced to the customer's exacting comfort requirements.

Suspension Range

Lovells Coil Springs Designed as a superior replacement part for mass produced O.E. (Original Equipment) coil springs. Lovells springs exceed original ratings by 10%-50%, thus handling is dramatically improved and many ride height variations are available for most makes of vehicles.

Lovells Coil Springs are manufactured to the highest standard from Australian made One Steel micro alloy spring steel.

Many Lovells Coil Springs are of a Progressive Rate design. This design enables a spring to increase in spring rate when you need it and decrease when you don't; ensuring the ultimate in handling and ride comfort. **5 YEAR unlimited km WARRANTY**



Suspension Range (Continued)

Lovells Leaf Springs

Lovells offer a vast range of semi elliptic leaf springs to satisfy popular ride height variations and load carrying capabilities. Lovells semi elliptic springs have the outstanding characteristics of not only acting as a spring, to resiliently support the vehicle, but also serve to position the axle, dampen vertical deflection and cushion both driving torque and braking reaction. Lovells leaf springs are manufactured to the highest standard from Australian made One Steel micro alloy spring steel.

5 YEAR unlimited km WARRANTY



Lovells Urethane Suspension Components

On going development in urethane technology has evenuated in Lovells being able to offer a urethane suspension bush that permits the comfortable ride, associated with rubber bushes, yet with the crisp handling geometry control and durability of urethane. The technology allows #60, #75, durometer urethane to survive the harshest of suspension applications and durability to match. Lovells Urethane Suspension Components are covered by a 2 YEAR/ 40,000km WARRANTY



actions and durability to match. Lovells Urethane Suspension Components are covered by a 2 YEAR/ 40,000km WARRANTY

Lovells Shock Absorbers (Series III)

GAS LEGEND TWIN-

TUBE GAS CHARGED; 40mm bore and huge 60mm expanded body design provides up to twice the oil capacity of Original Equipment shock absorbers to maximise fade resistance, run cooler and allow fast reaction time to road changes.

Gas Legend Twin-Tube shock absorbers feature:

- ◆ Teflon banded steel pistons and nylon mechanical top out stops.
- ◆ Piston retainer nuts, mechanically peened to stop failure at high temperature.
- ◆ Multi stage valving system to allow a progressive dampening effect from slow to fast piston velocity thus automatically adjusting to all conditions.
- ◆ Shafts are manufactured from tough 20mm hardened chrome micro alloy steel, precision engineered to withstand the harshest of environments, while reducing friction and wear.
- ◆ Piston rod seals are Viton high quality, high temperature multi-lip design to again reduce friction and provide longer life.
- ◆ Robust 1.5mm thick external and internal walls.

- ◆ Gas charged with low pressure nitrogen gas to maximise fade resistance under extreme conditions without harshness while providing more responsive control.
- ◆ All eyes and pin mounts are doubled welded for extra strength and long life.

Lovells Gas Legend Shock Absorbers are covered by 3 YEAR/ 70,000km WARRANTY.



Lovells Steering Dampers/Stabilisers

GAS LEGEND HEAVY DUTY and RETURN TO CENTRE; Large capacity replacement steering dampers have a 30mm bore and piston and incorporate Foam Cell technology.

Reduce unwanted steering vibration and harshness on rough roads, without interfering with normal steering control. Absorbs steering shock and vibration caused by road irregularities such as cracks, corrugations, holes, rocks and wheel tracks.

Gas Legend Steering Dampers feature:

- ◆ Superior 12.5mm hard chrome piston rod.
- ◆ Tough cold coiled coil spring on RTC versions.
- ◆ 50/50 Multi stage valving system to allow a progressive dampening effect from slow to fast piston velocity thus automatically adjusting to all conditions.

- ◆ Mounts are Robotic Double Welded

Lovells Gas Legend Steering Dampers are covered by 3 YEAR/ 70,000km WARRANTY.



Lovells Heavy Duty Torsion Bars

Bars are available as an up grade to enhance the load carrying ability of vehicles which have independent front ends. Lovells Torsion Bars are manufactured with larger diameter bar than original equipment which will increase spring rate and maintain ride height when the vehicle is fitted with load bearing accessories (LBA) over the front. Eg. Bull bar or winch. Lovells Torsion Bars feature 'upset' forged ends which increase strength by improving the steel structure and rolled splines. Lovells heavy duty torsion bars are covered by a 2 YEAR/ 40,000 km WARRANTY



Suspension Range (Continued)

Lovells Shackles & Pins

Manufactured using the finest quality materials and case hardened to 0.2mm, to provide greater resistance to wear, thus increasing pin and bush life. Machined load bearing surfaces allow for increased dispersion and coverage of grease, which greatly improves performance and reduces shackle and pin deterioration.

All Lovells shackles, plates and pins are manufactured to exceed Original Equipment specifications. The majority of Lovells shackles and pins are fully greaseable with easy accessible grease nipples and come complete with nuts & washers.

Lovells shackles and pins are covered by a 2 YEAR/ 40,000km WARRANTY.



Lovells U-Bolts

Manufactured from high tensile premium quality cold formed rod, incorporating rolled threads to ensure material structure continuity and increased strength. Lovells U-bolts are coated with a rust preventative for long life and come complete with high tensile deep nuts and spring washers. Lovells U-bolts are covered by a 2 YEAR/ 40,000km WARRANTY.



Lovells Suspension Kits

Lovells offer complete 4x4 suspension kits, with properly 'matched' components to ensure vehicle handling characteristics and load carrying ability are correct, safe and uncompromised. To achieve this, Lovells initially carry out an evaluation of a vehicle via road testing, component analysis and performance and specification examination. Road testing involves driving a vehicle over many types of terrain, with and without loads before subjective

judgement is made on how Lovells could improve the performance of the vehicle in terms of ride height, handling, load carrying capacity (up to the manufacturers recommended GVM). Suspension systems are then designed as a combination to ensure spring rates, suspension travel and handling compliment our shock absorber controls and other components. Performance including load capabilities verses ride comfort is also taken into consideration. Engineering samples are left on a vehicle for *durability* testing for periods of up to 12 months.



Lovells Gross Vehicle Mass (GVM) Upgrades and Towing Upgrades (BTC Upgrades)

The solution for owner/managers of most popular 4x4 vehicles who need to carry and tow loads beyond OE capacities while at the same time meeting practical and documentary compliance requirements of Work Safety, Police Licensing, Insurance, Lessors and Fleet Managers.

The Lovells GVM and BTC upgrade kits have been strenuously studied, tested and refined. In conjunction with leading Engineering Signatories and have been fitted to many of Australia's largest fleets during the past twenty years. Lovells GVM Upgrade Kits have full Federal Compliance by the Department of Infrastructure, Transport, Regional Development and Local Government and all have specific Compliance plate Approvals and Compliance plates fitted to prior to registration. They are simply then registered with a new GVM as per the new compliance plate.

Lovells GVM Upgrade and BTC Upgrade Kits come complete with all suspension components, All Terrain Offroad Hitch, new compliance plate and full fitting and testing procedures.



Ride Height Options

Vehicle ride heights (Eye Brow Heights) are measured vertically from the centre of the wheel hub to the edge of the guard.

Vehicle ride heights are approximate only and can vary depending on:

- ◆ Age of vehicle
- ◆ Load Bearing Accessories (ie. bullbars, winches, extra fuel tanks, fridges, spare wheel carrier etc.)

When selecting springs all of the these factors must be taken into consideration.

Eye Brow Height

Measuring of the "Eye Brow Height -E.B.H." is illustrated in the following Diagram

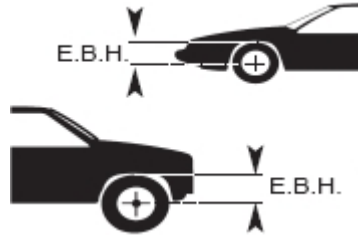

FRONT / REAR

IMPORTANT: Pay close attention to all symbols, foot

Customer Specific Design and Spring Identification

If the springs you require are not listed in the catalogue, please make enquiries with our customer service technicians who will arrange for the manufacture of custom springs to your specification and / or sample.

To achieve initial design parameters we will require the following:

Static (working) height: The length of the coil spring whilst still mounted in the vehicle under normal load.

Trapped height: The overall length of a coil spring

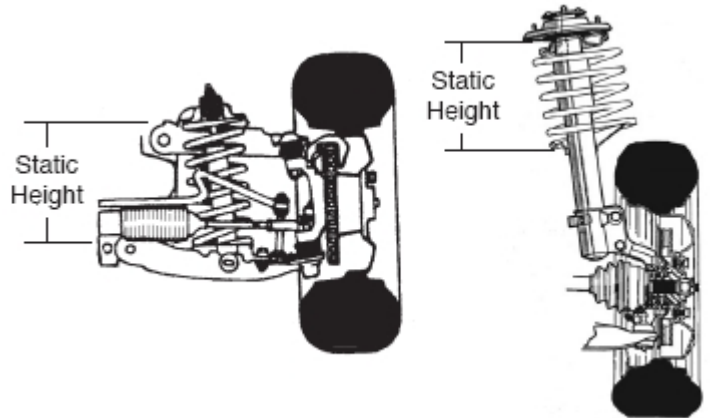

when still in the vehicle while the body of the vehicle is jacked up, to full extension of shock absorber.

Free height: The overall length of a coil spring at its longest part while not under load i.e. out of the vehicle

Designation	Approximate ride height change
Std Height	Standard
H/Duty Std Height Raised	Maintains Std Height when vehicle is fitted with Load Bearing Accessories. Raises vehicle by approx 25-50mm
Raised H/Duty	Maintaining raised height when vehicle is fitted with Load Bearing Accessories - increasing load carrying capacity.
Additional Part No. Prefix	<p>HD - (Heavy Duty) extra heavy duty for increased load carrying capacity ie. larger fuel tanks, LPG tanks, camping / trekking cargo.</p> <p>LTO - (Long Travel Option) suits 4x4 vehicles with aftermarket shock absorbers which are normally longer than original and enable coil spring to remain trapped. LTO part numbers also suit O.E. original length shock absorbers.</p> <p>HDLTO - (Heavy Duty Long Travel Option) above two descriptions combined, suits 4x4 vehicles with longer shock absorber & increases load carrying capacity.</p> <p>NOTE: Spring selection for vehicles with L.B.A must be scrutinised carefully as variables such as location of equipment may change from vehicle to vehicle. The above details are given as an average only. Please consult Lovells Springs Pty. Ltd. for further details.</p>

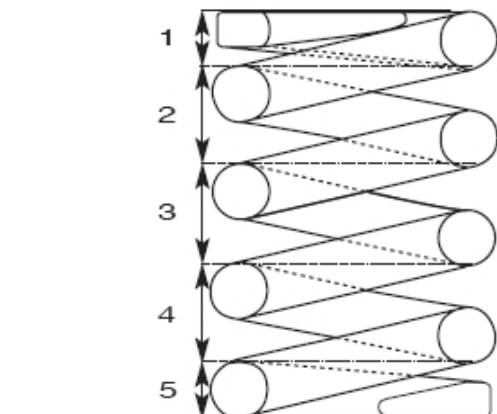
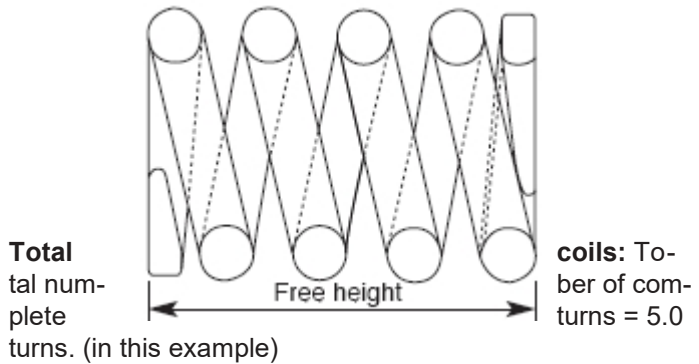

notes and advice in this catalogue.

INSTALLATION OF RAISED SUSPENSION SYSTEMS CAN INCREASE THE RISK OF VEHICLE ROLL OVER

Customer Specific Design and Spring Identification (Cont.)

Diameter of material: Use Vernier caliper to measure. Check at various points along coil and then check end coils as the diameter may vary.

Inside diameter (I.D): Use Vernier caliper to measure inside diameter of coil spring at both ends. Measure coil spring whilst out of vehicle.

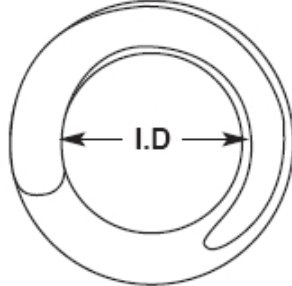

Spring end finish:

Normal: Unground, straight cut.

Ground: Ground flat

Reduced: End coil finishes smaller in diameter than main coils.

Fitting Guide

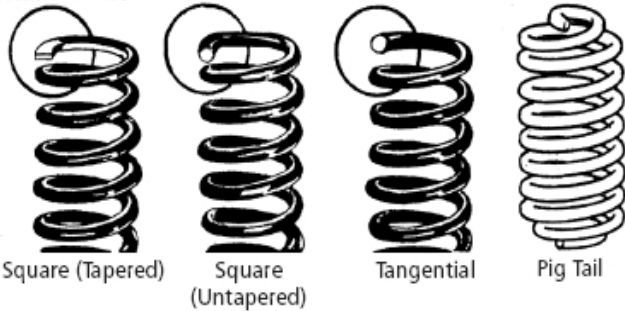

1. With vehicle on level (flat) ground, measure and record corner heights (E.B.H) from centre of rim to wheel arch.
2. With vehicle on flat ground measure and record static (working) height of O.E.M.(original) coils.(length of coil under load).
3. Lift vehicle and record trapped height of coil springs from front and rear. (wheels at full droop with springs and shocks still in vehicle).
4. Check inside diameter, top and bottom, of spring against O.E.M.(original) coils
5. Remove old suspension in accordance with vehicle manufacturers manual.
6. Reassemble new suspension components and fit to vehicle. Note: Final tensioning of all bolts & nuts to be done with suspension at normal ride height. Failure to observe this requirement may void any warranty.
7. Align vehicle to manufacturers specifications. Place vehicle on level ground and record final corner heights (E.B.H) from centre of rim to wheel arch.

Important: U-bolts must be checked regularly & retensioned.

For Maximum leaf spring life, after fitment of new leaf springs, U-bolts must be retensioned after 500klm with vehicle fully laden.

Lovells recommend all U-bolts to be checked regularly & retensioned if required. Torque settings are available upon request.

Glossary

Symbol	Description
All	All engine sizes within year of manufacturer
D	Diesel Powered Engines
P	Petrol Powered Engines
T	Turbo
□	Model on going
H/Top	Hard Top
S/Top	Soft Top
T/Back	Tray Back or Cab Chassis
P/Up	Pick Up or Utility
D/Cab	Dual Cab
Xtra Cab	King Cab
S/Rig	Spray Rig (suits vehicles with water tanks eg fire trucks etc)
M/Use	Mine Use
GVM	Gross Vehicle Mass Upgrade
MD	Medium Duty
XHD	Extra Heavy Duty
LWB	Long Wheel Base
SWB	Short Wheel

Catalogue Information

Information contained herein supersedes all previous catalogues. Information regarding vehicle specifications i.e. build dates, make & model & engine type have been sourced from industry accepted manuals, refer bibliography. Due to frequent vehicle production changes, no responsibility will be accepted by Lovells Springs Pty. Ltd. for any inaccuracies or variances of information contained in this catalogue.

Copyright

This catalogue may not be reproduced in whole or part without the written consent of Lovells Automotive Systems Pty. Ltd.

Trading Terms & Conditions

Refer www.lovells.com.au

Bibliography

The Red Book - Identification Manuals.